



United States  
Department of  
Agriculture

Forest Service

Pacific Northwest  
Research Station

General Technical  
Report  
PNW-GTR-854

November 2011



# Synthesis of Knowledge of Extreme Fire Behavior: Volume I for Fire Managers

Paul A. Werth, Brian E. Potter, Craig B. Clements, Mark A. Finney,  
Scott L. Goodrick, Martin E. Alexander, Miguel G. Cruz, Jason A.  
Forthofer, and Sara S. McAllister



A SUMMARY OF  
KNOWLEDGE FROM THE

**Joint  
Fire Science  
Program**



The **Forest Service** of the U.S. Department of Agriculture is dedicated to the principle of multiple use management of the Nation's forest resources for sustained yields of wood, water, forage, wildlife, and recreation. Through forestry research, cooperation with the States and private forest owners, and management of the national forests and national grasslands, it strives—as directed by Congress—to provide increasingly greater service to a growing Nation.

The U.S. Department of Agriculture (USDA) prohibits discrimination in all its programs and activities on the basis of race, color, national origin, age, disability, and where applicable, sex, marital status, familial status, parental status, religion, sexual orientation, genetic information, political beliefs, reprisal, or because all or part of an individual's income is derived from any public assistance program. (Not all prohibited bases apply to all programs.) Persons with disabilities who require alternative means for communication of program information (Braille, large print, audiotape, etc.) should contact USDA's TARGET Center at (202) 720-2600 (voice and TDD). To file a complaint of discrimination, write USDA, Director, Office of Civil Rights, Room 1400 Independence Avenue, SW, Washington, DC 20250-9410 or call (800) 795-3272 (voice) or (202) 720-6382 (TDD). USDA is an equal opportunity provider and employer.

## Authors

**Paul A. Werth** is a fire weather meteorologist (retired), Northwest Interagency Coordination Center, 150 SW Harrison Street, Suite 400, Portland, OR 97201. **Brian E. Potter** is a research meteorologist, U.S. Department of Agriculture, Forest Service, Pacific Wildland Fire Sciences Laboratory, 400 N 34<sup>th</sup> St., Suite 201, Seattle, WA 98103. **Craig B. Clements** is an assistant professor of meteorology, San Jose State University, San José, CA 95192. **Mark A. Finney** is a research forester, **Jason A. Forthofer** is a mechanical engineer, and **Sara S. McAllister** is a research mechanical engineer, U.S. Department of Agriculture, Forest Service, Missoula Fire Sciences Laboratory, 5775 Highway 10 West, Missoula, MT 59808. **Scott L. Goodrick** is a research meteorologist, U.S. Department of Agriculture, Forest Service, Southern Research Station, 320 Green Street, Athens, GA 30602. **Martin E. Alexander** is an adjunct professor of wildland fire science and management, Department of Renewable Resources and Alberta School of Forest Science and Management, University of Alberta, Edmonton, AB T6G 2H1, Canada. **Miguel G. Cruz** is a senior research scientist, Bush Fire Dynamics and Applications, CSIRO Ecosystems Sciences–Climate Adaptation Flagship, GPO Box 284, Canberra, ACT 2601, Australia.

## Cover Photos

Cover photos by Rick Trembath, USDA Forest Service (retired).

# **Synthesis of Knowledge of Extreme Fire Behavior: Volume I for Fire Managers**

**Paul A. Werth, Brian E. Potter,  
Craig B. Clements, Mark A. Finney,  
Scott L. Goodrick, Martin E. Alexander,  
Miguel G. Cruz, Jason A. Forthofer,  
and Sara S. McAllister**

U.S. Department of Agriculture, Forest Service  
Pacific Northwest Research Station  
Portland, Oregon  
General Technical Report, PNW-GTR-854  
November 2011

Published in cooperation with:  
U.S. Department of Agriculture, Forest Service  
Southern Research Station

This page was intentionally left blank.

## **Abstract**

**Werth, Paul A.; Potter, Brian E.; Clements, Craig B.; Finney, Mark A.; Goodrick, Scott L.; Alexander, Martin E.; Cruz, Miguel G.; Forthofer, Jason A.; McAllister, Sara S. 2011.** Synthesis of knowledge of extreme fire behavior: volume I for fire managers. Gen. Tech. Rep. PNW-GTR-854. Portland, OR: U.S. Department of Agriculture, Forest Service, Pacific Northwest Research Station. 144 p.

The National Wildfire Coordinating Group definition of extreme fire behavior (EFB) indicates a level of fire behavior characteristics that ordinarily precludes methods of direct control action. One or more of the following is usually involved: high rate of spread, prolific crown-ing/spotting, presence of fire whirls, and strong convection column. Predictability is difficult because such fires often exercise some degree of influence on their environment and behave erratically, sometimes dangerously. Alternate terms include “blow up” and “fire storm.”

Fire managers examining fires over the last 100 years have come to understand many of the factors necessary for EFB development. This work produced guidelines included in current firefighter training, which presents the current methods of predicting EFB by using the crown fire model, which is based on the environmental influences of weather, fuels, and topography.

Current training does not include the full extent of scientific understanding. Material in current training programs is also not the most recent scientific knowledge. National Fire Plan funds have sponsored newer research related to wind profiles’ influence on fire behavior, plume growth, crown fires, fire dynamics in live fuels, and conditions associated with vortex development. Of significant concern is that characteristic features of EFB depend on conditions undetectable on the ground, relying fundamentally on invisible properties such as wind shear or atmospheric stability.

Obviously no one completely understands all the factors contributing to EFB because of gaps in our knowledge. These gaps, as well as the limitations as to when various models or indices apply should be noted to avoid application where they are not appropriate or warranted. This synthesis will serve as a summary of existing extreme fire behavior knowledge for use by fire managers, firefighters, and fire researchers.

The objective of this project is to synthesize existing EFB knowledge in a way that connects the weather, fuel, and topographic factors that contribute to development of EFB. This synthesis will focus on the state of the science, but will also consider how that science is currently presented to the fire management community, including incident commanders, fire behavior analysts, incident meteorologists, National Weather Service office forecasters, and firefighters. It will seek to clearly delineate the known, the unknown, and areas of research with the greatest potential impact on firefighter protection.

Keywords: Extreme fire behavior, fuels, fire behavior.

## **Preface**

In 2008, the National Wildfire Coordinating Group (NWCG) Fire Behavior Committee (FBC) asked the Joint Fire Science Program (JFSP) to fund a synthesis and review of the scientific literature pertaining to extreme fire behavior (EFB). In September 2008, the JFSP announced a call for proposals that included a request for “an examination of the state of the science underlying predictions of extreme fire behavior, and an assessment of the appropriate uses and limits of this information.” This document is the result of that request.

In performing the review, it became progressively clearer that the concept of extreme fire behavior (EFB) is vaguely defined and means something different to everyone. The authors examined the official NWCG definition and solicited input from the management community to develop a definition that was both operationally useful and scientifically tractable. This definition and the initial stages of the review eventually led to the recognition that some relevant topics had not been included in the original outline. Other topics from the original outline were expanded to include sections of their own.

The authors communicated these changes to both the JFSP and the FBC as they arose. In those conversations, it became apparent that these two groups had different needs. The JFSP needed something for fire managers and others without the technical background of a fire behavior analyst. The FBC needed a document for fire behavior analysts that would allow them to better understand the use and limitations of the tools they now have and may have in the near future. To meet these two needs, this review has two parts. Volume 1 summarizes the state of the science for fire managers and firefighters with pertinent references to scientific papers. It is intended to be of use to anyone who works at or near the fireline. Volume 2 covers the same topics (with one exception) in more detail and includes information necessary for fire behavior analysts to understand what is scientifically known, what science lies behind the tools they have, and what the limitations are on scientific knowledge and tools. It includes more references to scientific literature. The one difference in topical content between the volumes is that volume 2 includes a chapter on fuel dynamics and volume 1 does not. As the study progressed, the scope of this topic led to the need to include more experts, and the short time available precluded that section from publication in volume 1.

## Summary

A working definition of extreme fire behavior (EFB) was necessary for development of this synthesis. Because the subjective nature of four of the five properties of the EFB definition established by the National Wildfire Coordination Group makes the definition intractable for scientific purposes, the lead authors asked the fire behavior community for input on possible definitions of EFB and examples of phenomena they considered EFB. The only coherent theme was that EFB is not steady state. After discussing responses, the authors agreed on the following working definition for this project:

Fire spread other than steady surface spread, especially when it involves rapid increases.

This definition of EFB does not emphasize any one element of the behavior triangle.

## Complexity

It is imperative that fire managers understand that much of what is referred to as “extreme fire behavior” is happening where it cannot be seen. Multiple factors come into play and not all factors need be present for EFB to occur. No one factor must be present in every case.

A number of interactions among the elements are noted, but the number of possible interactions between elements is practically unlimited, making research and the resulting tool development a key step in achieving successful forest management and safety.

## Myths and Lore

There are many myths and lore with limited scientific basis. Anecdotal evidence sometimes takes the place of science and comes to be accepted as fact even when little scientific information exists to validate it. Extreme fire behavior can occur on any scale, great or small, in any fuel type, and at any time of the day or night. There is no time or circumstance when fire managers can safely assume EFB will not occur.

## Over-Arching Gaps

The authors of this synthesis have identified areas in each chapter where understanding of the science is lacking and more research is needed. These knowledge gaps may pertain to just one chapter’s topic, but they are nonetheless important areas in which further research would be of value to the operational community. There are, however, certain over-arching gaps where additional research of one element will advance the science for other elements as well.

- A greater recognition of the importance of plume dynamics to EFB and spotting.
- Advances in the understanding of fuel structure, especially as it relates to ember production and crown fire.
- Better high-resolution observations on windflow in complex terrain to improve wind models used in fire behavior and spotting tools, and to identify fire whirl potential. For example, upper air soundings on project-size fires.
- The influence of ambient winds or topography on fire interactions.

- More research beyond the Haines Index to quantify the effects of atmospheric stability on fire behavior.

New and expanded research into these areas will increase the understanding of the science on which they are based and are a necessary starting point for enhanced wildland fire management and advances in firefighter training and safety.

### Operational implications

Even the most advanced tools and models are limited by their design and assumptions. They can never, nor should they be expected to, take the place of direct observations one makes on the fireline, such as the “L” in LCES (Lookouts-Communications-Escape Routes-Safety Zones) and the concept of “situational awareness.” Scientifically sound application of tools and models requires that the tools/models be used within their design limitations and in accordance with the tool assumptions.

Current training identifies circumstances that can result in extreme fire behavior, where increased awareness of multiple factors can guide fire managers to make decisions.

Research can lead to development of additional or improved tools to help fire managers better identify those situations where extreme fire behavior may occur. The lack of a tool or model for a situation seen in the field does not mean EFB cannot occur. Knowing what conditions can lead to EFB, and knowing that you do not know whether those conditions exist, can be more important than any tools or models. Extreme fire behavior can occur on any fire.

The state of the science at present can be summed up as follows:

- Fire is three dimensional and is not steady state.
- The tools available to us today are two dimensional and are predominantly steady state.
- Additional research into EFB may one day result in development of three-dimensional tools.



## Contents

- 1 **Chapter 1: Introduction**  
*Brian E. Potter and Paul A. Werth*
- 1 Definition
- 2 Methods
- 3 Literature Cited
- 5 **Chapter 2: Effects of Complex Terrain on Extreme Fire Behavior**  
*Craig B. Clements*
- 5 **Introduction**
- 5 **Wind Systems in Mountainous Terrain**
- 6 Dynamically Driven Winds
- 10 Thermally Driven Winds
- 16 Wind Modeling Tools: WindNinja
- 17 **Summary**
- 18 **Future Needs**
- 19 **Literature Cited**
- 25 **Chapter 3: Critical Fire Weather Patterns**  
*Paul A. Werth*
- 25 **Introduction**
- 25 **Weather Elements That Promote Extreme Fire Behavior**
- 27 **Critical Fire Weather Patterns**
- 29 **Regional Critical Fire Weather Patterns**
- 30 Northern Plains, Great Lakes, and the Northeastern United States
- 31 Southeastern United States
- 32 Southwestern United States
- 34 Rocky Mountain and Intermountain Regions
- 37 Pacific Northwest Region
- 39 California Region
- 42 Alaska
- 43 **Models and Predictive Tools**
- 43 The National Wildland Significant Fire Potential Outlook
- 43 GACC 7-Day Significant Fire Potential
- 45 Fuel and Fire Behavior Advisories
- 45 Other GACC Products and Services
- 45 Fire Weather Watches and Red Flag Warnings
- 45 Spot Weather Forecasts/Digital Web Services
- 45 **Summary/Knowledge Gaps**
- 46 **References**
- 49 **Chapter 4: Fire Interactions and Mass Fires**  
*Mark A. Finney and Sara S. McAllister*
- 49 **Introduction**
- 50 **Background: Time-Dependent Fire Behaviors**
- 50 Fire Acceleration

51	Length of Fire Front
52	Flame Tilt
53	Spread Thresholds
53	<b>Conditions Where Fire Interactions Occur</b>
54	<b>Specific Effects of Fire Interaction</b>
54	Burning Rate
56	Flame Dimensions
58	Flame Temperatures and Pollutants
59	Indraft Velocity
61	Pulsation
62	Convection Column
63	Summary of Interaction Effects
63	<b>Needs for Further Research and Application</b>
64	<b>Literature Cited</b>
73	<b>Chapter 5: Column/Plume Dynamics</b>
	<i>Brian E. Potter</i>
73	<b>Introduction</b>
74	<b>Plume-Dominated and Wind-Driven Fires</b>
74	<b>Adverse Wind Profiles and Low-Level Jets</b>
75	<b>Stability and Instability</b>
76	<b>Downbursts and Plume Collapse</b>
78	<b>Summary</b>
78	<b>Literature Cited</b>
81	<b>Chapter 6: Spot Fires</b>
	<i>Brian E. Potter</i>
81	<b>Introduction</b>
81	<b>The Spotting Process</b>
83	<b>Management Tools</b>
85	<b>Knowledge Gaps</b>
86	<b>Literature Cited</b>
89	<b>Chapter 7: Vortices and Wildland Fire</b>
	<i>Jason A. Forthofer and Scott L. Goodrick</i>
89	<b>Introduction</b>
89	Vorticity Basics
90	<b>Fire Whirls</b>
91	Fire Whirl Physics
91	Vorticity Sources
92	Vortex Stretching
93	Increased Combustion Rates
93	Scaling Fire Whirls
93	<b>Fire Whirls in the Real World: Common Features</b>
93	Whirl Shedding on the Lee Side of a Plume

94	L-Shaped Heat Source in Crossflow
94	Vorticity Associated With Cold Fronts
94	Multiple Interacting Plumes
95	Lee Side of a Hill/Mountain
95	<b>Horizontal Vortices</b>
96	Transverse Vortices
96	Longitudinal Vortices
99	Tree Crown Streets
100	<b>Summary</b>
101	<b>Knowledge Gaps</b>
102	<b>Literature Cited</b>
107	<b>Chapter 8: Crown Fire Dynamics in Conifer Forests</b> <i>Martin E. Alexander and Miguel G. Cruz</i>
107	<b>Introduction</b>
108	<b>Types of Crown Fires</b>
111	<b>Crown Fire Initiation</b>
115	<b>Crown Fire Propagation</b>
115	<b>Crown Fire Rate of Spread</b>
116	<b>Crown Fire Intensity and Flame Zone Characteristics</b>
117	<b>Crown Fire Area and Perimeter Growth</b>
119	<b>Crown Fire Spotting Activity</b>
121	<b>Models, Systems, and Other Decision Aids for Predicting Crown Fire Behavior</b>
121	Rothermel Guide to Predicting Size and Behavior of Crown Fires
122	U.S. Fire Modeling Systems
124	Canadian Forest Fire Behavior Prediction System
125	Other Empirically Based Approaches
126	Physically Based Models
129	Example of a Practical Application of Linking Empirical and Physically Based Models
130	<b>Implications for Fire and Fuel Management</b>
134	<b>Future Outlook</b>
135	<b>Literature Cited</b>
143	<b>Acknowledgments</b>
143	<b>Unit Conversion Factors</b>
144	<b>Common and Scientific Names</b>

This page was intentionally left blank.

# Chapter 1: Introduction

Brian E. Potter and Paul A. Werth<sup>1</sup>

The idea of “extreme fire behavior” (EFB) is commonplace in the U.S. wildland fire community. It goes back, arguably, to the 1950s and the idea of a “blow-up” fire presented by George Byram. Byram (1954) listed the terms “blow up,” “conflagration” and “erratic” as descriptors of “unusual high-intensity fires.” He also used the phrase “extreme fire behavior” in both his 1954 paper and in his chapters in Davis (1969). Larger fires may be more likely to display these characteristics, he noted, but they can occur on a fire of any size. Since then, the concept and terms have become widely used.

In spite of this widespread use and implied understanding of what constitutes EFB, there is no documented, critical examination of the types of fire behavior people consider “extreme.” Furthermore, whereas there is little question that the behavior labeled as EFB by observers occurs, there are numerous explanations for that behavior that are now conventional wisdom, yet without any scientific support—the phenomenon is rarely in question, but the explanation may be. Actions based on incorrect explanations of EFB can result in death or injury.

The primary goal of this synthesis is to summarize what is known scientifically about matters considered EFB. That summary is presented to provide the most value possible to the operational fire management community. Research papers, although increasingly available to everyone, are not necessarily understandable by everyone. They contain substantial jargon and math, and may only summarize their findings in terms of basic science. This synthesis distills the scientific information and provides references to the research papers. Note that science is a process of proposing possible explanations, and subsequently ruling out those explanations that contradict evidence. It is easy to propose explanations, but proving them wrong can be easy or difficult. An explanation that is repeatedly tested,

compared to observations, and never contradicted is not necessarily true, but the more it is tested, the more confidence scientists have that it may be, true. In the case of EFB, hard, reliable data are rare, making it very difficult to confidently refute a proposed explanation. Rather, it is much more common to be able to cite scientific reasons for greater or lesser confidence in the proposed explanation. In this synthesis and review, the authors hope to present what hard evidence there is, and when there is none, to provide an understanding of the strong and weak points in a given explanation.

## Definition

A working definition was necessary to begin and execute the synthesis. Without it, the task of gathering and summarizing would be unbounded and impossible to complete. There is no single scientific paper that laid out a scientific definition of EFB. The only official or specific definition of EFB is established by the National Wildfire Coordination Group (NWCG) glossary of wildland fire terminology (NWCG, n.d.):

“Extreme” implies a level of fire behavior characteristics that ordinarily precludes methods of direct control action. One or more of the following is usually involved: high rate of spread, prolific crowning and/or spotting, presence of fire whirls, strong convection column. Predictability is difficult because such fires often exercise some degree of influence on their environment and behave erratically, sometimes dangerously.

Of the five properties “usually involved,” four are subjectively described as “high,” “prolific,” or “strong.” This makes the definition intractable for scientific purposes. Furthermore, the definition implies a need to fail at direct control in order to designate the fire behavior as “extreme.”

<sup>1</sup> **Brian E. Potter**, U.S. Department of Agriculture, Forest Service, Pacific Wildland Fire Sciences Laboratory, Seattle, WA.

**Paul A. Werth**, Weather Research and Consulting Services, LLC, Battle Ground, WA.

This makes EFB a function of control success or failure, not an objective, physical process.

At the initiation of this project, the lead authors asked the fire behavior community for input on possible definitions of EFB and examples of phenomena they considered EFB, whether those examples matched the NWCG definition or not. Several people responded—mostly with examples—either via email or through MyFireCommunity.net, and the authors used that feedback in their initial discussion of the working definition. The phenomena listed in these responses included:

- Mass ignition.
- Actual plume dominance.
- Rapid exponential growth of spot fires.
- Spotting distances in miles.
- Things that just made me go, “Huh ... didn't expect that.”
- Fire activity that has that momentum feedback character, like Jimi Hendrix putting the guitar up to the amp, and it just builds and builds feeding back on itself.
- When the fire and convection column induce high levels of turbulence into the wind field; when the momentum flow into the convection column is of the same order of magnitude as the momentum in the wind field.
- Very rapid fire spread.
- Three-dimensional fire.
- Fire behavior in which large changes take place rapidly.
- Flame attachment (the laying over and direct contact of flame with new fuels when there are steep slopes and strong winds).

The responses made it quite clear that operational users had thought about EFB well beyond any formal definition. They also recognized the difficulty of creating a precise definition that could be applied predictively, or a definition more concrete than “I know it when I see it.” After reviewing and discussing practitioner responses, the authors felt

that there were too many individual phenomena considered EFB for a definition to include any sort of list. Furthermore, most tractable definitions included some level of subjectivity. In the end, the agreed definition for this project was:

Fire spread other than steady surface spread,  
especially when it involves rapid increases.

This definition includes most or all of the phenomena listed above, although admittedly indirectly in some cases. It does include some subjectivity, as “rapid” can be a matter of opinion. However, this is not the core of the definition—it is included to emphasize the safety and operational importance of increasing spread as opposed to decreasing or unusually slow spread. Furthermore, whereas the NWCG definition heavily leans toward atmospheric conditions and may underrepresent the importance of fuels and topography, this definition does not emphasize any one element of the behavior triangle.

## Methods

The authors divided the work of synthesis and review based on expertise. The division is necessary to the synthesis, but it is also artificial, and the various sections overlap substantially. Many areas of overlap are explicitly noted, and readers will undoubtedly see other areas.

The review incorporated three primary sources of information. First and foremost was the peer-reviewed scientific literature. This is the most authoritative source of information to support or refute any explanation of what causes EFB. Second was feedback from and interaction with practitioners. The project Web site allowed reader comments and discussion, and, when appropriate, these guided the review. The third source was documents that are not peer reviewed—often referred to as “grey literature.” Peer review was the exception to the rule for many years in the field of forest fire research, so there is an extensive body of literature that was not peer reviewed. The problem with grey literature is that it has not been tested or widely available, so the scientific rigor of its content is unknown. It can, however, provide insight and information, and the authors did not want to ignore it.

## **Literature Cited**

**Byram, G.M. 1954.** Atmospheric conditions related to blowup fires. Sta. Pap. 35. Asheville, NC: U.S. Department of Agriculture, Forest Service, Southeastern Forest Experiment Station. 34 p.

**Davis, R.T. 1969.** Atmospheric stability forecast and fire control. *Fire Control Notes*. 30(3): 3–4, 15.

**National Wildfire Coordinating Group [NWCG]. [N.d].** Glossary of wildland fire terminology. <http://www.nwcg.gov/pms/pubs/glossary/index.htm>. (June 1, 2011).

This page was intentionally left blank.



## Chapter 2: Effects of Complex Terrain on Extreme Fire Behavior

Craig B. Clements<sup>1</sup>

### Introduction

Atmospheric processes in regions of complex terrain have received considerable interest in the research community for decades. Traditionally, the term “complex terrain” has been used to differentiate mountainous terrain from relatively flat and simple terrain. Research in mountain meteorology has its foundation in the Alps, and our present understanding of mountain circulations and the mountain atmosphere in general came from the early observational studies of Wagner (1938), Ekhardt (1944), and Defant (1949).

The mountain meteorology research community most likely adopted the term “complex terrain” from the Atmospheric Studies in Complex Terrain the (ASCOT program) or which focused on observational campaigns of thermally driven circulations in valleys and, in particular, Colorado’s Brush Creek Valley (Whiteman 1990).

A new classification of mountainous terrain by Meybeck et al. (2001) provided 15 relief patterns based on relief roughness and elevation. Relief roughness is defined as the difference between maximum and minimum elevation divided by half the length of cell used in the elevation data set (e.g., digital elevation model [DEM]). This terrain parameter is similar to the average slope typical of terrain classifications. Although Meybeck et al. determined many terrain types, they did not define any as complex terrain. Meybeck et al. classified mountains as terrain with elevations higher than 500 m and relief roughness greater than 20 percent. One problem with this classification is that high plateaus are not mountains. Major river valleys can be incised into a high plateau such as the Grand Canyon. Although this is not “mountainous terrain,” it is complex.

Most applicable to meteorological use of the term “complex terrain” is when defining the effect that land shape or topography has on meteorological measurements

(Brode et al. 1987). These terrain effects include aerodynamic wakes, density-driven slope flows, channeling effects of upper level winds, and flow accelerations over the crest of mountain ridges. These flows affect the windspeed and wind direction measurements made in mountainous regions.

For fire behavior applications, the term “complex terrain” is used to describe regions of relative relief and, in most cases, mountain topography.

### Wind Systems in Mountainous Terrain

Wind systems in mountainous terrain can be classified into two main types based on their forcing mechanisms: dynamically driven and thermally driven winds. Although thermally driven circulations occur more regularly in mountain terrain and are commonly experienced by hikers and climbers during fair weather conditions, it is the dynamically driven winds that can play a larger role in producing extreme fire behavior owing to their generally stronger surface wind velocities. However, the thermally driven circulations are subject to diurnal transition periods where atmospheric stability changes twice daily, potentially leading to extreme changes in observed fire behavior. This chapter will review the main mesoscale and local-scale wind systems observed in mountainous terrain that can potentially lead to extreme fire behavior.

#### Dynamically Driven Winds

Dynamically driven winds are generally considered the strongest of the wind systems in mountainous terrain and include downslope windstorms such as foehn and Santa Ana winds, strong surface winds associated with mountain wave development, gap winds, and channeling of synoptic-scale winds. The factors that affect these terrain-forced winds as summarized by Whiteman (2000) are (1) the

<sup>1</sup> Craig B. Clements, Department of Meteorology and Climate Science, San José State University, San José, CA.

stability of the air approaching the mountains, (2) the speed of the airflow, and (3) the characteristics of the underlying topography or mountain barrier.

#### **Foehn Winds—**

One of the most important dynamically driven winds affecting fire behavior in mountainous terrain is the Chinook or foehn wind. Foehn winds (pronounced “firn”) are downslope wind events and are often associated with extreme fire behavior because of their near-surface high windspeeds, warm temperatures, and low relative humidities (Durrant 1990, Whiteman 2000). As foehn develops, its onset can cause rapid changes in temperature and humidity because of adiabatic compression as air descends the lee side of mountain ranges. Extreme fire behavior can potentially occur during nighttime at the onset of a foehn event; strong winds will prevent nocturnal inversions from forming allowing nighttime temperatures to remain warmer (Whiteman 2000). Foehn winds can also start and stop suddenly, called a foehn pause (Whiteman 2000). The alternating wind break-in and cessation during a foehn event can cause air temperatures to oscillate sharply and can thus affect fire behavior. The foehn pause has been associated with changes in upstream conditions, including stability and cross-barrier windspeed that cause the wavelength of the waves to change (Whiteman 2000), and to lifting of the foehn wind by other local drainage flows (Baumann-Stanzer and Piringer 2004).

Foehn winds are common in most mountainous regions around the world. In the lee of the Rocky Mountains of North America they are called Chinooks. The Chinook is most prevalent in winter months when strong westerly winds cross the Rockies (Whiteman 2000); however, when the synoptic conditions are right, Chinooks do occur during fire season (see the next chapter, “Critical Fire Weather Patterns”).

In northern California, foehn winds that flow from the Great Basin over the Sierra Nevada to the Central Valley are known as north winds and in the region of Yosemite are called mono winds (Ruscha 1976). Even more localized

in the San Francisco Bay area, these winds are known as Diablo winds. Foehn winds in the Cascade Mountains of the Pacific Northwest are called east winds as they blow from the east of the Cascades and descend becoming warmer and drier over the west slope of the mountain range. In Utah, the local foehn is known as the Wasatch wind as it descends from the higher elevations east of the Wasatch Mountains to the Salt Lake Valley. A comprehensive review of foehn winds of the Western United States is found in Whiteman (2000).

#### **Santa Ana winds—**

The most notable foehn wind associated with extreme fire events is the Santa Ana of southern California. High windspeeds and extreme dryness associated with these episodes have been characterized as causing extreme fire behavior during fall in southern California. Barry (2008) stated that the Santa Ana develops as a result of high pressure over the Great Basin and development of a surface low off the southern California coast. An upper level trough to the east and a ridge in the eastern North Pacific cause the development of northerly flow.

Hughes and Hall (2009) suggested that the surface winds associated with Santa Ana events are produced by two mechanisms. When strong mid-tropospheric winds impinge on mountaintops in a stably stratified environment, gravity waves transfer midlevel momentum to the surface, causing strong lee-side surface winds. However, Hughes and Hall (2009) found strong variability in Santa Ana events with many days exhibiting strong offshore flow and weak synoptic forcing. They suggested local thermodynamic forcing must also cause offshore surface flow. When cold air is trapped in the Great Basin by topography, a hydrostatic, desert-ocean pressure gradient forms resulting in a negatively buoyant gravity current to flow through mountain gaps at the surface.

Numerical modeling results by Huang et al. (2009) showed that a coupling between the synoptic scale and mesoscale exists leading to the development of Santa Ana winds. The coupling effects of the synoptic scale with the

mesoscale are classified in three stages. During stage I, mesoscale subsidence occurs in the exit region of the jet stream causing an initial surge of dry air to the surface as a result of moisture divergence behind a surface cold front in the Southwestern United States. During stage II, anti-cyclonic curvature of the jet stream increases, and strong northeasterly winds in the jet exit region advects dry air toward the California coast. During stage III, the extremely dry mid-tropospheric air is transported to the boundary layer on the east side of the coast range caused by wave breaking and strong turbulence that lead to the formation of a hydraulic jump creating the Santa Ana winds.

There have been many studies focused on the large-scale dynamics of Santa Ana events, but few studies have investigated extreme fire behavior associated with these events. One recent study was made by Maranghides and Mell (2009) who conducted a postincident analysis of the fire behavior that occurred during the Witch and Guejito Fires near San Diego, California, in 2007. Surface winds in the region were approximately 11 m/s with gusts of 15 m/s. A home weather station in the region reported a maximum windspeed of 25 m/s. Relative humidity dropped from 90 to 8 percent during the onset of the Santa Ana wind event. Spread rates during the Guejito Fire were estimated between 1.7 and 2.5 m/s (3.7 and 5.6 mi/h). Spotting distances were estimated to be approximately 4.5 km (2.8 mi) from the Guejito Fire front. The surface wind measurements were limited to just a few sites in the region of these fires, but indicate very strong surface winds and rapid fire spread. Better measurements of fire-atmosphere interactions during Santa Ana events would lead to improved understanding of extreme fire behavior during such events.

*Esperanza Fire*—The Esperanza Fire occurred on 26 October 2006 near Cabazon, California, and was an event where extreme fire behavior was associated with five firefighter fatalities. The extreme fire behavior was caused by the fire spread up a narrow canyon enhanced by flow channeling created by the onset of a Santa Ana wind (Coen and Riggan 2010, Esperanza Investigation Team 2006). One key finding (finding 29, Esperanza Investigation Team 2006)

was that none of the fire shelters for the five firefighters that were killed by the burnover were deployed, indicating that the head fire must have accelerated as it came up the creek drainage and caught all firefighters by surprise leaving them no time to deploy their shelters.

One of the major contributing factors was the Santa Ana winds coming into alignment with the “unnamed creek drainage” as a channeled flow increasing the surface winds in the canyon. Additionally, the inversion was penetrated by the convection column from the fire run up the canyon, resulting in extreme fire behavior and area ignition. Coen and Riggan (2010) confirmed the presence of strong winds that aligned with the canyon; however, these surface winds were a result of atmospheric gravity waves bringing high-momentum east-northeasterly winds to the surface.

#### **Sundowner winds—**

Another foehn wind that has played a major role in observed extreme fire behavior is the sundowner wind of Santa Barbara, California. The sundowner is a localized downslope wind that flows from the Santa Ynez Mountains down to the narrow coastal plain of Santa Barbara. The topography is unique, as it is a section of coastline and mountains that are aligned west to east. The winds are a result of perpendicular flow at ridgetop, typically associated with warmer and drier air near the mountaintops and cooler, higher humidity air at the coast. The extreme effects of the winds include the onset of severe wind velocities and abrupt warming. The abrupt observed warming is a result of the adiabatic descent of mid-tropospheric air to the surface and the replacement of cooler marine air at the coast with the foehn wind (Blier 1998). The sundowner name is due to the time of onset, typically during the later afternoon or evening hours (Ryan 1994). One synoptic regime associated with sundowner events includes the alignment of an inverted ridge off the California coast and inverted trough in the interior of the Great Basin allowing for northerly winds along the California coast (Blier 1998). Additionally, as with other foehn events, the presence of a stable layer at ridge height enhances the flow and formation of mountain waves (Blier 1998). Sundowners have been associated with extreme fire

behavior. For example, during the Painted Rock Fire in June 1990, an extreme sundowner event caused devastating winds and fire spread rates. Additionally, downslope winds can cause severe downslope fire spread as noted by Weise and Biging (1996).

#### **Washoe zephyr—**

The eastern Sierra Nevada is associated with strong Chinook wind events in the winter and spring (Zhong et al. 2008a). During the summer and fall, however, the Washoe zephyr occurs regularly. The Washoe zephyr is a daytime, down-canyon wind that occurs on the lee side of the Sierra Nevada (Clements 1999, Zhong et al. 2008a) often initiating afternoon thunderstorms in western Nevada (Hill 1980). Zhong et al. (2008a) defined the Washoe zephyr as a westerly wind with a sustained windspeed greater than 7 m/s starting after noon Local Standard Time (LST). Climatology of the zephyr indicates that 85 percent of the time, these events start between 1300 and 2000 LST with 70 percent onset between 1500 and 1800 LST. Half of the events have a duration of 3 to 6 hr, and few events last more than 9 hr (5 percent). Although zephyr events do occur all year, they are most frequent during the summer months. A frequency of less than 10 percent was observed from November to February.

The characteristics of the Washoe zephyr are somewhat opposite of what is generally observed in mountainous terrain where up-valley winds dominate in the afternoon. The zephyr develops in late afternoon during the summer and fall, and blows strongly down canyon with velocities regularly exceeding 5 m/s. The vertical wind profile of the zephyr is characterized by a strong low-level jet that produces strong wind shear and turbulence (Clements 1999, Kingsmill 2000) at the surface. Wind shear can be defined as the change in windspeed or wind direction with height (vertical wind shear). The strong and gusty nature of the zephyr lasts throughout the night and finally diminishes, allowing thermally driven down-valley winds to persist until morning (Clements 1999).

The dynamics of the Washoe zephyr have often been questioned. Zhong et al. (2008a) showed through mesoscale

numerical modeling and climatological analyses that the Washoe zephyr is driven by the cross-barrier pressure gradient formed in response to the thermal low of the Great Basin.

One incident in the lee of the Sierra Nevada that could be attributed to a Washoe zephyr-like event occurred during the Seven Oak Fire of the Inyo Complex (California Department of Forestry and Fire Protection 2008). On the afternoon of 7 July 2007 at 1400 Pacific Daylight Time (PDT), a strike team was assigned to burn out an area in order to protect the historical Mount Whitney Fish Hatchery on the western side of Owens Valley near the town of Independence, California. The site was just below the eastern escarpment of the Sierra crest. At 1430 PDT, the wind had changed and caused the fire to cross the planned control line. It is reported that at 1445 PDT, the fire intensified and the winds increased and began changing directions. At this time, the firefighters realized they were losing control and retreated toward their designated safety zone and deployed their shelters while waiting out the burnover in a small pond. The entrapment resulted in burn and respiratory injuries to all nine firefighters and the total loss of one engine and damage to another. The incident report indicated that skies were clear with no cumulus buildup. The day before, when the fire started, there were frequent lightning strikes in the higher elevations of the Sierra with strong, gusty and erratic winds. A 26 m/s (58 mi/h) wind gust was recorded by fire personnel using a Kestrel handheld anemometer. Daytime temperatures on July 7<sup>th</sup> ranged from low 32 to 38 °C (90s to 100 °F) at 1247 PDT. Relative humidity (RH) values ranged from a high of 13 percent to a low of 4 percent at 1447 PDT. At the Oak Creek remote automated weather station (RAWS), a wind gust of 22 m/s (50 mi/h) also occurred at 1447 PDT. Winds in the afternoon were sustained 4.5 to 6.7 m/s (10 to 15 mi/h) gusting to 13 m/s (30 mi/h). At the time of the burnover, winds were 9 to 13 m/s (20 to 30 mi/h) out of the southwest.

Although the southeastern Sierra is not usually associated with Washoe zephyr events because of the higher terrain and fewer gaps in the crest, the observed characteristics

have some similarities to the zephyr. Southwesterly winds with recorded velocities of 4.5 to 6.7 m/s (10 to 15 mi/h) are similar to what has been observed in Lee Vining and Reno to the north. The onset of the stronger winds occurring between 1400 and 1500 is typical for zephyr events. However, the Washoe zephyr typically has a more westerly component, but this could possibly be effects of flow channeling along the foothills of the Sierra eastern escarpment as found by Zhong et al. (2008b).

#### **Terrain channeling effects—**

Forced channeling or pressure-driven channeling of upper level, larger scale winds can cause drastic changes in windspeed and direction to occur in valleys (Whiteman 2000). These high wind events can be produced by (1) downward momentum transport, (2) terrain channeling, and (3) pressure-driven channeling (Whiteman 2000, Zhong et al. 2008b). For a more detailed review on terrain channeling effects in mountainous regions, please refer to the paper by Sharples (2009).

The downward transport of momentum occurs when winds within a valley are strongly coupled to winds aloft (Zhong et al. 2008b). For this condition to occur, there must be vertical mixing associated with unstable or neutral stability allowing upper level winds to penetrate to the surface. When winds in a valley are driven by this mechanism, they are expected to align with the wind direction aloft. Downward transport of momentum in valleys occurs often.

Another channeling effect is “forced channeling,” which occurs when strong winds aloft blow directly along the valley’s axis (Whiteman 2000). According to Whiteman, forced channeling occurs more regularly during daytime because the valley atmosphere is usually neutral or unstable during the day. It typically begins in later morning after the breakup of the nocturnal inversion, resulting in abrupt changes in windspeed and gustiness. Forced channeling is strongest when the pressure gradient aloft is weak in the along-valley direction. Upper level winds can also be channeled when they blow at oblique angles to the valley axis, either flowing up or down the valley.

*Thirtymile Fire*—The Thirtymile Fire investigative report indicates that fire-induced winds were associated with the deaths of four firefighters who deployed at a site located 30 m upslope from the valley floor. The analysis suggests that the deployment site happened to be located at a point where the convection column had impinged on the valley sidewall, causing extensive convective heat to pass over the deployment site leading to the asphyxiation of the entrapped firefighters. While initially, winds in the canyon were relatively light during the early afternoon, strong fire-induced winds were reported to be on the order of 22 m/s (50 mi/h) during the onset of the deployment (Brown 2002).

Tree needle heatset observations made at the deployment sites (Brown 2002) indicated that the fire-induced winds were in the up-canyon and upslope direction suggesting that the convection column was being channeled up the canyon rather than rising vertically from the surface. The fact that the convection column near the surface was being advected up canyon suggests that the surface winds were blowing through the fire-front boundary. Additionally, observed spread rates at this time increased and caught the firefighters off guard (Brown 2002). The increase in fire spread rate was a result of the fire running in the crowns, driven by the up-canyon winds. At the same time, upper level winds were from the southwest and in alignment with the canyon’s axis providing a source for increased wind velocities. The upper level winds may have been mixed downward from aloft to the surface owing to the dynamics of the convection plume. The downward mixing of horizontal momentum could help explain why the fire front accelerated and caused the turnover to happen so quickly. These events can be surgelike and last for only a few minutes. Another mechanism that could be responsible for the convection column to have impinged on the canyon sidewall might be strong downdrafts that exist in plumes or convection columns. These downdrafts can be responsible for the strong fire-induced winds that are often observed at the fire front and may drive fire spread (Clark et al. 1996, Clements et al. 2007).



Another mechanism possibly responsible for the intense fire-induced winds could be a developing low pressure field. This may have existed in the upper elevations of the canyon ahead of the fire front. This type of pressure perturbation ahead of the fire front has been found in numerical simulations done over flat terrain (Clark et al. 1996) and observed over slopes with crosswinds (Clements and Heilman 2010). A region of low pressure develops as a result of a hydrostatic pressure gradient that forms at the base of the convection column (Clark et al. 1996). Within a canyon during daytime, low pressure exists owing to the solar heating of the canyon volume causing up-canyon winds to occur. With the additional heating caused by the advection of the plume up the canyon, acceleration in the wind field could result and be the cause for the extreme fire-induced winds that blew through the fire front advecting hot gases along the sidewalls of the canyon. Although these mechanisms could be responsible for the plume impingement on the canyon sidewall, none has been confirmed.

#### **Pressure-driven channeling—**

Pressure-driven channeling occurs when there exists a larger scale pressure gradient above the valley that is superimposed on the valley below. The direction of the winds in the valley depends on the along-valley component of the horizontal pressure gradient. Pressure-driven channeling causes winds to always blow along the valley axis from high pressure (end of valley) to low (end of valley) (Whiteman 2000, Zhong et al. 2008b). Pressure-driven channeling is strongest when the along-valley pressure gradient is strongest in the along-valley direction.

#### **Thermally Driven Winds**

Thermally driven wind systems are very common because they are diurnally driven (daytime vs. nighttime) and are probably experienced more by wildland firefighters and backcountry hikers. These winds include the classic valley and slope winds. There is a distinct diurnal structure to the evolution of the thermally driven flows where their direction typically reverses daily owing to changes in the pressure gradient and buoyancy.

Two main circulations exist in the valley atmosphere: valley winds and slope winds. The valley winds consist of two diurnal regimes: the up-valley wind during the daytime and the down-valley wind at night. The slope winds consist of a similar diurnal structure with downslope winds occurring during the nighttime periods and upslope winds during the daytime (Ekhardt 1944; Vergeiner and Dreiseitl 1987; Whiteman 1990, 2000). The strength of thermally driven circulations is a function of aspect, time of day, and time of year (Whiteman 2000). Of the two wind systems, the valley winds play a larger role in fire behavior because of their overall stronger velocities and horizontal extent.

#### **Slope winds—**

Slope winds are the most intermittent of the thermally driven flows found in mountain environments (Vergeiner and Dreiseitl 1987, Whiteman 1990). This is due to both slope length and depth. Although there have been numerous studies focused on the downslope flows (Horst and Doran 1986, Mahrt 1982, Manins and Sawford 1979, Papadopoulos and Helmise 1999, Whiteman and Zhong 2008), limited work has been focused on the upslope winds. Vergeiner and Dreiseitl suggested that this is due to their intermittency and overall difficulty in obtaining useful measurements. They also concluded that any field study focused on measuring upslope flows will “give random inconclusive results from which representative values of mass and heat transport in the slope layer cannot be derived” (Vergeiner and Dreiseitl 1987).

Fire behavior studies on slopes and especially field studies are limited, and therefore it is difficult to determine whether or not diurnal slope flows help drive the fire along the slope rather than being dominantly driven by the fuels and the effect of radiative and convective transfer from the fire front to the fuels (flame attachment). However, as will be discussed in a later section, the interaction of slope winds and valley winds can create shear layers producing turbulence along the slopes that can potentially lead to extreme fire behavior scenarios.

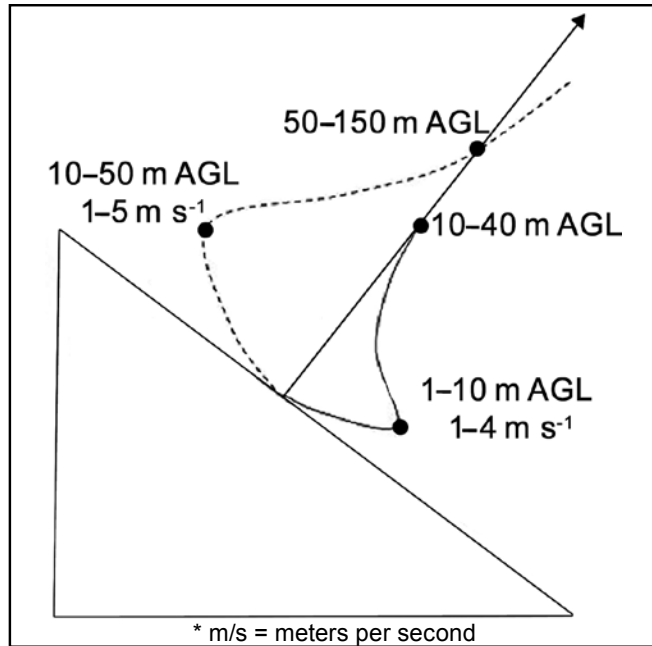

Figure 2-1—Schematic diagram indicating vertical slope flow structure for daytime upslope flows (dashed line) and nighttime downslope flows (solid line). Adapted from Whiteman (2000). AGL = above ground level.

### Upslope winds—

According to Whiteman (2000), upslope flows have depths of 10 to 50 m above ground level (AGL) and velocities on the order of 1 to 5 m/s<sup>2</sup> (fig. 2-1). Upslope flows react instantly to changes in insolation and begin immediately after sunrise (Vergeiner and Dreiseitl 1987). Two main forcing mechanisms drive the flow upslope: the pressure gradient force and the buoyancy force (Atkinson 1981). The air over a slope is heated by insolation leading an air parcel adjacent to the slope to have a higher potential temperature and lower density than air at the same altitude, but away from the slope. It is this temperature perturbation that drives the pressure gradient to force air toward the slope from the center of the valley (at the same altitude). Buoyancy drives the air parcel vertically above the slope, and the sum of both buoyancy and the horizontal pressure gradient causes the air parcel to accelerate up the slope while being replaced by air from over the valley center. This is the classic upslope circulation during ideal, fair weather conditions and is

responsible for transporting heat and mass to the valley atmosphere (Vergeiner and Dreiseitl 1987).

One of the more recent observations of upslope flows was made by Reuten et al. (2005) who observed upslope flows at the foot of a mountain range with a slope angle of 19° and a ridge height of 780 m above sea level (ASL) in coastal British Columbia. Their observations indicate that the daytime upslope flows were strong with velocities up to 6 m/s and occurred over a depth of nearly 500 m AGL. Equally strong and deep return circulations occurred within the convective boundary layer (CBL). The transport of mass of the upslope flow and return flow approximately balanced during the morning period suggesting a closed-cell slope flow circulation within the boundary layer. This is the first observational evidence of the closed cell slope flow circulation.

The intermittency of daytime upslope flows may influence the upslope fire behavior by possibly increasing upslope rate of spread at random intervals. However, this influence is more likely limited owing to the weak nature of the upslope velocities. Valley winds may have a larger impact on fire behavior on slopes owing to the cross-slope wind component of the valley winds. As the valley wind develops, the valley wind can overcome the slope wind layer along the slope and create cross-slope flow (Whiteman 2000). Fire spread will be upslope, but depending on the strength of the valley wind, can likely be reduced and spread laterally along the slope. Synoptically forced winds that penetrate the valley atmosphere would intensify this effect.

### Fire behavior on sloped terrain—

Slope-driven fire spread has been studied for decades because many wildfires occur in regions of mountainous terrain, and fire spread on slopes is associated with increased acceleration leading to extreme fire behavior (Cheney and Sullivan 2008). Understanding of fire behavior on slopes is derived mostly from laboratory-scale experiments conducted in wind tunnels (e.g., Weise and Biging 1996); however, recently a number of numerical simulations have been conducted (Linn et al. 2010). The effect of slope

has been viewed as an added component of wind velocity since 1946 (Weise and Biging 1997). There have been attempts to determine both the separate and combined effects of wind velocity and slope angle on spread rate and flame length (Weise and Biging 1997). Results from Weise and Biging indicate that as slope and wind velocity increase, fire behavior, including flame length and spread rate, increases significantly as compared to no-wind and downslope conditions. Backing fires on slopes can result in weak to no spread. Weise and Biging suggested that the wind acts to cool the unburnt fuel in advance of the fire front.

Santoni et al. (1999) formulated a model to account for upslope fire spread and compared the solution to experimental results obtained using a tilted, combustion table. They suggested that the flame's heat that is radiated ahead of the fire front toward the fuel is more important under slope conditions. They found that the rate of spread increases with slope. They also found that the fire front shape distorts toward the slope as the fire spreads upslope becoming more pointed. The fire front distortion increases with increasing slope angle.

#### **Chimney effects—**

An important aspect of upslope wind on fire behavior would be the effect that chimneys or steep gullies have on driving wind up the mountainside. Gullies can help channel upslope flows if the chimney is not lined with dense vegetation. Within the canopy, the air is usually cooler than the free atmosphere and can result in drainage winds flowing below the canopy top while upslope winds occur above the canopy (Belcher et al. 2008, Whiteman 2000). Few, if any, observations of wind velocities in steep gullies exist.

#### **Explosive fire behavior—**

Eruptive fire behavior has been reviewed by Viegas and Simeoni (2010) where they define extreme fire acceleration as fire blowup characterized by a sudden change of spread rate and energy release rate. This designation was first proposed by Viegas (2005), and such fire eruptions, especially those associated with canyons, are not rare (Viegas and Simeoni 2010). Laboratory studies using a combustion

chamber and a fuel bed configured on a tilting, V-shaped table to replicate a steep chimney were conducted by Viegas and Pita (2004) and Viegas (2005). Their conclusions suggest that forest fire blowup depends mainly on fuel-bed properties and on the initial fire spread conditions dictated by topography or wind. Viegas (2005) also found that if the slope is not sufficiently long, blowup may not occur; however, a fire in the same fuel bed on a very steep slope will start with a high rate of spread (ROS), and blowup may be obtained quickly. These studies do provide some insight, but they are limited by the experimental design as are most chamber-table studies owing to the limited table length. Dold and Zinoviev (2009) and Dold (2010) suggested that air ahead of a fire front that is spreading upslope flows up the slope, causing plume attachment with the fuels on the slope and leading to acceleration of fire spread upslope. Additionally, this leads to potentially dangerous acceleration of the fireline. They suggested that the airflow is generated by the fire and is independent of the ambient wind.

Wu et al. (2000) conducted a series of laboratory experiments and successfully visualized experimental fire plumes interacting with an inclined surface by using a grid schlieren system. They found that plumes were characterized by two parameters, plume attachment length and plume angle, and these were used to determine a critical inclination angle for flame attachment to occur. Their results suggest that 24° is a critical angle for attachment to occur. Additionally, Wu et al. found that the critical inclination angle is not sensitive to the heat release rate or surface conditions.

Dupuy and Maréchal (2011) conducted a series of laboratory fire experiments to determine the contribution of radiation and convection to fuel bed preheating on slopes of 0°, 10°, 20°, and 30°. Their results indicate that radiative heating is the dominant heat transfer mechanism on slopes between 0° and 20°, but close to the fireline. Convective heating was also found to be significant, becoming one-third of the total heat flux on the 20° slope. When the slope angle increased from 20° to 30°, the rate of spread increased by a factor of 2.5 owing to an increase in convective heating; also at this angle, radiative heating stopped increasing.



Their results also showed that far from the fireline, cooling by convection was found to be substantial except on slopes of 30° in angle.

Sharples et al. (2010a) suggested that the trench effect or flame attachment phenomena observed in structure fires of stairwells can be used as a surrogate for wildland fires exhibiting explosive behavior. The trench effect produces rapid fire spread in enclosed slopes such as escalator or stairwells by the interaction of the buoyant plume and an inclined trench of the stairwell. Plume impingement on an inclined surface enhances preheating and pyrolysis of the fuel resulting in accelerated fire spread. Sharples et al. (2010a) suggested that the trench effect is a misnomer and the effect is really due to the trenchlike configuration of the fuels that limited lateral entrainment into the plume. They suggested that plume attachment or flame attachment are more appropriate to describe the phenomenon. This conceptual model applies to steep gullies or canyons, as these terrain features can potentially limit the lateral entrainment into the plume and result in eruptive or accelerated fire spread up the canyon.

Sharples et al. (2010a) also noted that confined slopes over 25° are the most prone to flame attachment and the reason observed eruptive wildfire behavior is more prevalent on steep slopes and in steep canyons. This observation is in agreement with the results from Wu et al. (2000) who suggested 24° as a critical slope angle for flame attachment to occur.

#### **Modeling of fire behavior on slopes—**

To date, most studies aimed at determining the role of slope on fire behavior have based their models on wind tunnel experiments. More recently there have been attempts using physics-based, coupled fire-atmosphere modeling systems to evaluate the role of slope on fire behavior (Linn et al. 2007, 2010). Using the FIRETEC modeling system (Linn et al. 2002, Linn and Cunningham 2005), Linn et al. (2010) simulated fire behavior on a 30° slope with different fuel types and found that the slope alone has a significant effect on spread rate and spread pattern. This result confirms the results of Weise and Biging (1997) and Santoni et al.

(1999), but the most significant finding from the FIRETEC simulations was that the spread rate of all simulations is not the same at a point near the bottom of the hill and a point near the top, even though the slope is the same at each point. Linn et al. (2010) remarked that this result indicates that simply having a single value of local slope angle of a hill and a single nominal windspeed is not adequate to predict the spread rates on slopes.

Linn et al. (2007) also showed that under certain conditions, the local slope had a more pronounced effect on spread rate than ambient wind. For example, numerical simulations showed that fire spread was dominated by the topography at locations on the middle of a slope when ambient winds were 6 m/s, whereas at other locations upwind of the slope, the fire behavior was strongly influenced by the coupling between the topography and ambient wind. This result indicates the importance of understanding the local winds that are influenced by the topography. The local wind field drives the fire behavior, and the topography has a more pronounced effect on the wind field rather than directly on the fire. Additionally, Linn et al. (2007) found a relationship among fire behavior, topography, and atmosphere that showed importance when the topographically influenced winds are not complementary to the slope effects such as those reported by Weise and Biging (1997).

Because present knowledge of fire behavior on slopes and in gullies is a result of laboratory experiments and numerical modeling studies, there is still a large gap in understanding the role of slope-scale winds on fire spread on slopes. Therefore, there is an immediate need for well-designed field experiments.

#### **Downslope winds—**

Downslope winds, also known as katabatic and drainage winds, develop once the slope becomes shaded as the sun sets. This reversal in the heating causes a shallow layer of cold air to develop along the slope, and this cold layer of air is now more dense than the surrounding air. As a result, it flows or drains downslope. As in the upslope winds, downslope winds are driven primarily by temperature differences between the air on the surface of the slope and that

at the same elevation away from the slope. Observations of downslope flows over simple slopes indicate that the velocities range from 1 to 4 m/s and occur within a depth of 10 to 40 m above the slope (Horst and Doran 1986, Papadopoulos and Helmise 1999, Whiteman 2000).

Because downslope winds have limited vertical extent and are typically much weaker in velocity, their effect on fire behavior may be limited. The downvalley winds most likely play a larger role on fire behavior-over the slopes in a mountain valley. Valley winds typically “overrun” the weaker slope flows once the down-valley winds become established throughout the night.

Once the surface winds become decoupled owing to the buildup of a nocturnal inversion at the valley floor, fire behavior can change dramatically with a change in direction or a decrease in spread rates, flame lengths, and intensity. These changes can also be attributed to relative humidity recovery near the surface.

#### **Valley winds—**

Valley winds, also known as along-valley winds, are a much more consistent wind regime than slope flows and are typically associated with much stronger velocities. The dynamic forcing is similar to that for the slope winds with the exception that the forcing is driven by a valley volume effect. During daytime, the air in the valley is warmer than over the plain because its volume is less and it thus warms faster than the air over the plain (Schmidli and Rotunno 2010, Whiteman 1990). As a result, pressure is reduced in the valley while it is higher over the plain at an altitude that is the same elevation as the valley. The pressure gradient force is then directed from the plain to the valley (Whiteman 1990). During the night, the pressure gradient reverses and the winds blow down valley. Up-valley winds have velocities on the order of 3 to 8 m/s and down-valley winds about 3 to 6 m/s. Typically there exists an oscillation in the winds at night (Porch et al. 1991), which can affect fire behavior. The oscillations are thought to be caused by the interactions of air flowing out from tributary valleys into the main valley causing surges in the winds to occur at regular intervals on the order of 10 to 20 min. These surges

can lead to changes in fire spread rate if the surface wind accelerates to the surface. However, there have been no quantitative studies on how the valley wind can affect fire behavior during daytime or night.

Valley winds can sometimes be overcome by other mesoscale wind circulations especially in regions near coastlines. Seto and Clements (in press) observed the formation of a small fire whirl that formed during a prescribed fire when the prevailing up-valley wind was overcome by sea breeze. Observations from a micrometeorological measurement tower placed in the burn unit showed that the fire whirl formed immediately after the sea breeze entered the valley at the surface. The fire whirl was first observed in the flaming front but moved behind the fire line as it stretched about 200 m in the vertical. The fire whirl caused the fire crew to quickly reposition themselves away from the fireline to remain safe. After the fire whirl dissipated, firing operations resumed. Seto and Clements (in press) ascertained that the fire whirl was caused by horizontal vorticity that was generated as a result of near-surface wind shear formed by the interaction of the sea breeze and the up-valley wind.

#### **Inversion destruction in valleys—**

The diurnal evolution of vertical temperature structure in mountain valleys has been well established by extensive field and modeling studies (Whiteman 1982, Whiteman and McKee 1982). During the night, cold air forms over the slopes and at the valley bottoms forming a temperature inversion, where the temperature increases with altitude (Whiteman 2000). Inversion breakup occurs in the morning when the sun begins heating the surface, and during the transitional period that follows, it can produce significant changes in surface conditions such as increased windspeed, wind direction, temperature, and humidity. Inversions can also break up in the middle of the night when stronger upper level winds push out the valley inversion (Clements et al. 2003). This can occur in shallow valleys that are more exposed to upper level winds or when upper level winds are excessively strong. For these reasons, inversion breakup is a period likely to produce periods of extreme fire behavior.

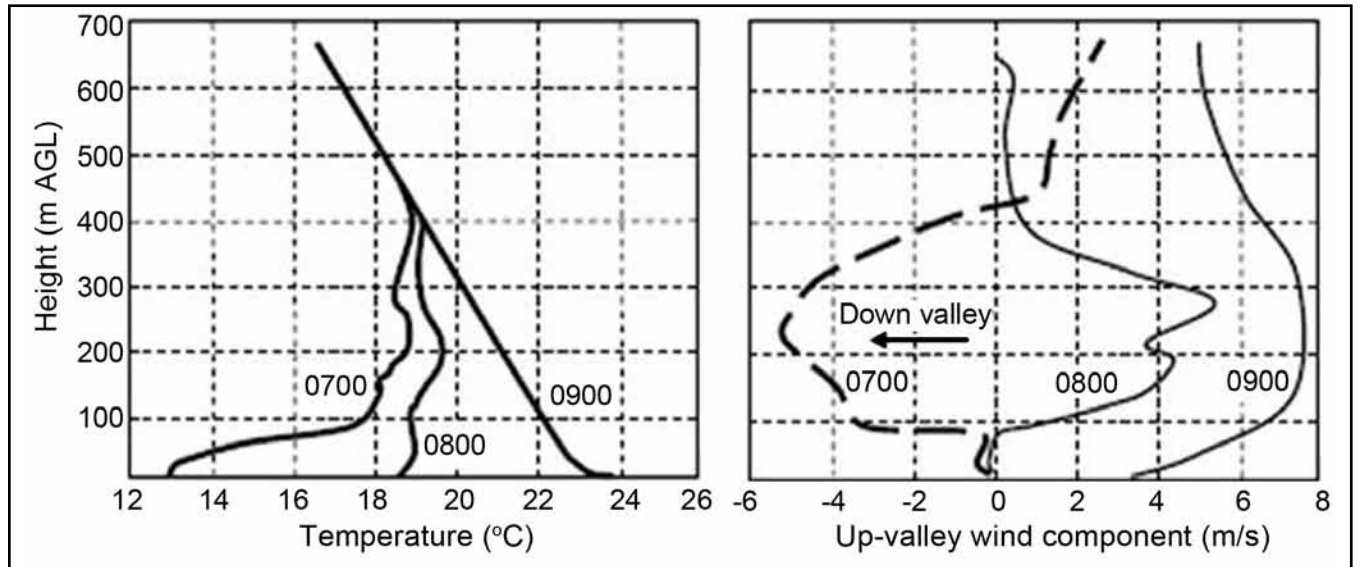

Figure 2-2—Temperature and windspeed profile evolution during valley inversion breakup in Yosemite Valley, California. Down-valley winds are negative and up-valley winds are positive. Once inversion is destroyed, up-valley winds mix downward to the surface causing a rapid increase in surface windspeed and direction. Times indicated are local time. Adapted from Clements and Zhong (2004). AGL = above ground level.

The breakup of temperature inversions can occur within 2 to 3 hr depending on valley geometry and season (Whiteman 1990). The most dangerous situation for increased fire behavior is when there is a strong down-valley wind that is decoupled from the surface by the surface inversion's capping inversion top (fig. 2-2). Once the inversion breaks, the stronger winds can mix quickly downward to the surface bringing drier and warmer air to the surface. Often the wind velocity can easily double and be associated with a 180° shift in direction. This situation is very common in valleys and can be anticipated on fires, but the rate of the inversion breakup and the decoupling of winds aloft should be estimated from smoke observations or a sequence of soundings taken on site.

The inversion breakup model of Whiteman (1982) is not observed in all valleys. During the Riviera Project in the Swiss Alps (Rotach et al. 2004), the thermodynamic structure and evolution was different than what was found in the valleys of the Colorado Rockies. Rotach et al. (2004) described a valley atmosphere that is stable throughout the afternoon rather than being well mixed as suggested by Whiteman (1982). However, there exists a multilayered

structure to the temperature profiles, which has been found in other valleys of the Alps. Thus, the stability regime can be quite different from valley to valley. To determine the local stability for fire behavior and fire weather predictions requires an in situ sounding at the time of interest. Inversions in valleys may or may not be horizontally homogeneous in extent, but rather developing in isolated pockets along the valley's axis. Locations along the valley floor may have areas of weaker surface inversions that could result in a faster inversion breakup and could potentially lead to different fire behavior only hundreds of meters away. Another aspect of valley inversions is the role they have on the thermal belt. Thermal belts are areas along valley sidewalls that are warmer than the areas below and above them. This can have an impact on the fuel loading, moisture content, and temperature, and resulting fire behavior.

#### Cross-valley winds—

Cross-valley winds can form as a result of either differential heating of slopes or dynamically forced flows through and over the terrain. Additionally, during the breakup of the valley inversion, solar radiation that illuminates one side of

a valley first causes a circulation to develop in the across-valley direction, as air within the center of the valley flows toward the heated sidewall and compensates for a slope flow and convection that develops in response to the solar heating (Colette et al. 2003, Whiteman et al. 2004). Rotach et al. (2004) found that valleys with bends can influence the location of the core of up-valley flow. In the Riviera Valley, the up-valley jet core was located closer to one valley sidewall because of the inertia of the flow as it came around a bend in the valley. This observation suggests that in valleys with sharp bends in the along-valley direction, the flow maxima can occur along one side of the valley. This characteristic can impact fire behavior in valleys by creating a stronger surface wind on one side of the valley. If the fire were to cross the valley by spotting, then the spread rate could potentially be much different than would be observed on the opposite valley sidewall.

#### **Turbulence in mountainous regions—**

Turbulence is defined as the perturbation from the mean of wind velocity. Little is known on the characteristics of atmospheric turbulent processes in steep mountainous terrain (Weigel et al. 2007). The role of turbulence on fire behavior has been suggested as a critical driving force at the fire front (Taylor et al. 2004) and larger ambient scales (Sun et al. 2009). Both the background ambient turbulence and the turbulence generated by the fire itself have an impact on resulting fire behavior (Sun et al. 2009).

Results from the Alps (Rotach et al. 2004, Weigel et al. 2007) found that there is a significant spatial variability in surface turbulence characteristics throughout the valley atmosphere, which is largely determined by local topographical features such as slope. It was also found that the maximum in shear-induced turbulence was found to occur on the eastern valley sidewall (sunlight) and near the center of the valley at the core of the valley wind. The turbulence-producing slope surfaces have a significant influence on the turbulence structure in large parts of the valley atmosphere. Consequently, fire behavior on slopes can be driven by a combination of slope effects and ambient turbulence that is generated by shear between the slope flow layer and the

valley wind. As found in the Riviera Valley, turbulence generation can often be dominated by wind shear. Intense turbulence is often associated with strong wind shear generated by strong surface winds such as during foehn events (Sharples et al. 2010b).

#### **Wind Modeling Tools: WindNinja**

Determining real-time wind characteristics on an incident remains a challenge for sites in complex terrain. This need has been partially addressed by the development of wind modeling systems by the USDA Forest Service using in-house and commercially available computational fluid dynamics codes. The most popular modeling system is WindNinja (<http://www.firemodels.org>), which is similar to the more complex WindWizard model (Butler et al. 2006). WindNinja takes a wind observation at a location and computes a spatially varying and high-resolution (100 m) wind field over the terrain, attempting to account for mechanical modification of the flow by the terrain. WindNinja is not a forecasting tool, but rather provides a “snapshot in time” of the wind for an area. WindNinja is becoming widely used on fire incidents by incident meteorologists and fire behavioral analysts. This is due to the nature of the system—it can be run on a laptop computer taking less than a minute to provide output. That is a big advantage as no forecasting system can provide this ease of use. The output from WindNinja is quite exciting for the user, but there are some major limitations of the system that users should be aware of. The numerics of the system are based on solving a rather simple set of mass continuity equations and optional slope flow equations. This simplicity is what makes WindNinja operate so fast on a laptop. These same simplifications are reason for caution when using it in complex terrain. First, the model is a mass-consistent model requiring air to flow around mountains rather than through them. The major pitfall for this type of model is the lack of thermodynamic fields to determine atmospheric stability, which would cause air to flow around or over terrain, and would limit its use for situations where thermally driven circulations dominate. The exception to this is a simple

slope flow submodel that is included in WindNinja. The model stability for flow computation is fixed for a neutral atmosphere (Butler et al. 2006), except in the initialization phase where WindNinja approximates lower atmosphere stability based on surface heat flux and subsequently uses a logarithmic vertical wind profile that includes adjustment for this stability. After the initialization phase, neutral stability is assumed for flow adjustment, but a method of relaxing this is currently being tested (Forthofer, J. 2011. Personal communication. Mechanical engineer, USDA Forest Service, Missoula Fire Sciences Laboratory, Missoula, MT), so the current version of WindNinja should not be expected to provide accurate simulations in situations where thermally driven flows are a dominating influence. For example, without the ability to run the model with specific stabilities such as a stable layer at crest height, the model may not be able to accurately model windflow during foehn events because the crest-level inversion is an important criteria for the development of downslope windstorms. Also, WindNinja may fail during inversion breakup or when a valley atmosphere is slightly stable during the day. Another enhancement currently being tested in WindNinja is to initialize with available weather model forecasts from, for example, the National Weather Service (Forthofer, J. 2011. Personal communication). WindNinja would then become a kind of physical downscaling of these coarse forecasts, which might further alleviate thermal stability issues in WindNinja because much of the thermal forcing might be included in the initialized field from the forecast model.

Kochanski et al. (2009) used multiple meteorological modeling systems, including WindNinja, to simulate flow over a simple hill. The performance and accuracy of WindNinja was much less than the other models, primarily because the version of WindNinja used did not allow for a user-defined vertical wind profile. Note that the other models used were much more sophisticated and required extensive computing time and processors in order to complete their simulations, whereas WindNinja did not. Forthofer (2007) simulated the same hill using a research version of WindNinja that did specify the measured upwind

vertical wind profile and showed much better results on the upwind and top of the hill. Flow on the lee side was less accurate, likely owing to the crude handling of momentum/turbulence in WindNinja, which becomes most important on lee slope locations.

Although there are limitations to the use of this type of modeling system in complex terrain, a user with an understanding of these limitations can use the model to get a general idea of the wind field over a fire area. This can be a benefit when there is a need to determine if the winds in an area are terrain forced and caused solely by topography. Because WindNinja provides a gridded wind field in under 1 minute of simulation time, it is a very capable tool, but users should have an understanding of the issues mentioned above. Finally, in the summer of 2010, a major field validation experiment was conducted to provide a comprehensive data set for testing and improving the WindNinja application (Forthofer, J. 2010. Personal communication). It is no doubt going to be an improved tool in the near future.

## **Summary**

Atmospheric processes in complex and mountainous terrain result in a variety of phenomena that can affect fire behavior in unpredictable ways. There are two main wind types that should be considered for better predicting fire behavior in mountainous regions: large-scale dynamically driven winds and thermally driven winds. The most notable dynamically driven winds are the foehn winds that occur in most mountain ranges in the Western United States. Foehn winds are known for increasing the surface winds dramatically and causing very rapid warming and drying at the surface. The Santa Anas of southern California are associated with extreme windspeeds and drying and have also led to flow channeling in narrow canyons resulting in extreme fire behavior including accelerated fire spread down canyon. To date there are few observations of fire-atmosphere interactions and resulting fire behavior during foehn events. More systematic observations are required to better understand extreme fire behavior during foehn.



Thermally driven winds in mountainous terrain occur regularly as they transition from up-valley/upslope during the daytime to down-valley/downslope at night. Thermally driven winds have weaker windspeeds than the dynamically driven winds and can be overcome by synoptic-scale winds aloft when atmospheric stability permits the downward transport of higher momentum into the valley atmosphere. These situations lead to a rapid increase of surface winds and fire spread rates.

One of the most critical factors affecting fire behavior in valleys is inversion breakup during the morning transition period. During the morning transition, a stable atmosphere at the surface quickly mixes and becomes unstable owing to the development of a convective mixed layer over the valley floor. When this occurs, winds aloft above the inversion layer, that were decoupled from the surface, can mix down quickly bringing much stronger velocities to the surface and usually from a different direction. These situations can potentially lead to extreme fire behavior by affecting spread rates and direction. To better anticipate these rapid changes, vertical profiles of temperatures should be measured in real time using radiosonde soundings or remote-sensing temperature profilers. Real-time observations would allow fire crews to know the state of the atmosphere at a given instance.

In addition to the valley inversion breakup, valley geometry can play a role in fire behavior. Valleys with sharp bends can have flow maxima along one side of the valley. This characteristic can potentially impact fire behavior in valleys by creating a stronger surface wind on one side of the valley. If the fire were to cross the valley by spotting, then the spread rate could potentially be much different than would be observed on the opposite valley sidewall.

Fire behavior on slopes is often explosive in nature as the fire accelerates up slope. To date, most studies have used either wind tunnel experiments or coupled atmosphere-fire numerical modeling systems. Results from these studies indicate that rate of spread increases with increasing slope and the fire front shape distorts toward the slope, becoming more pointed. The fire front distortion also increases with

increased slope angle. The increase in spread rate on slopes is caused by flame attachment to the fuel bed because the fuel is closer to the flame. A critical angle of 24° for flame attachment to occur has been found from laboratory studies. Observations in mountainous terrain confirm that slopes with angles over 25° are most prone to flame attachment and explains why observed eruptive fire behavior is prevalent on steep slopes and canyons.

Because present knowledge of fire behavior on slopes is mainly a result of laboratory experiments and numerical modeling studies, there is still a large gap in understanding regarding the role of slope-scale winds on fire spread on slopes. Numerical studies have shown that the terrain has a more pronounced effect on fire spread on slopes than the ambient wind. However, there are limited field data to support these results. Therefore, there is an immediate need for well-designed field experiments over sloped terrain to obtain a data set for model development and validation.

## Future Needs

Most measurements of fire behavior have been limited to laboratory, wind-tunnel experiments and numerical simulations. There are few, if any, field studies of fire-atmosphere interactions in real fires (Clements et al. 2007). Therefore, to further the understanding of the role of complex terrain on fire behavior, a major need is to conduct comprehensive field experiments on slopes and in mountainous areas. The data collected from these experiments can be used to test and develop models. Specific experiments that are needed include:

- Slope experiments with head fires starting on flat terrain and spreading upslope under various fuels and ambient meteorological conditions.
- Head fire experiments in chimneys and steep canyons.
- Experiments during inversion breakup on valley floors to investigate fire behavior during transition periods.

Idealized experiments are, however, limited to smaller scales and do not account for true wildfire conditions. To overcome this, measurements can be made by incident meteorologists at incidents. The National Weather Service incident meteorologist program has begun implementing the use of radiosondes on incidents rather than pilot balloons. Having profiles of temperature, humidity, and wind at high temporal and spatial resolution (about 1 s, 2 m) will allow the incident meteorologists and fire behavioral analysts to determine changes in atmospheric stability on site. Additionally, the use of remote sensing technology should be considered a priority. These sensors include Doppler wind LIDAR and passive microwave temperature and humidity profiles. Although the cost of these technologies is high, the data would provide great insight into the mechanisms of atmospheric dynamics on fire behavior in complex terrain.

## Literature Cited

- Atkinson, B.W. 1981.** Meso-scale atmospheric circulations. Maryland Heights, MO: Academic Press. 495 p.
- Baumann-Stanzer, K.; Piringer, M. 2004.** Foehn signals detected by sodar wind and turbulence measurements in the Rhine Valley, Austria, during the MAP field phase. *Meteorology Atmospheric Physics*. 85: 125–139.
- Barry, R.G. 2008.** Mountain weather and climate. 3<sup>rd</sup> ed. Cambridge, United Kingdom: Cambridge University Press. 506 p.
- Belcher, S.E.; Finnigan J.J.; Harman, I.N. 2008.** Flows through forest canopies in complex terrain. *Ecological Applications*. 18: 1436–1453.
- Blier, W. 1998.** The sundowner winds of Santa Barbara, California. *Weather and Forecasting*. 13: 702–716.
- Brown, H. 2002.** Thirtymile Fire: fire behavior and management response. *Fire Management Today*. 62(3): 23–30.
- Bennett, E.; Brode, R.; Dicke, J. Eskridge, R.; Garrison, M.; Irwin, J.; Koerber, M.; Lockhart, T.; Method, T.; Perkins, S.; Wilson, R. 1987.** On-site meteorological program guidance for regulatory modeling applications. EPA-450/4-87-013. Research Triangle Park: NC: U.S. Environmental Protection Agency.
- Butler, B.W.; Forthofer, J.M.; Finney, M.A.; Bradshaw, L.S.; Stratton, R. 2006.** High resolution wind direction and speed information for support of fire operations. In: Aguirre-Bravo, C.; Pellicane, P.J.; Burns, D.P.; Draggan, S., eds. Monitoring science and technology symposium: unifying knowledge for sustainability in the Western Hemisphere. Proc. RMRS-P-42CD. Fort Collins, CO: U.S. Department of Agriculture, Forest Service, Rocky Mountain Research Station: 595–602.
- California Department of Forestry and Fire Protection. 2008.** Hatchery Incident Investigation Report, CA-CSR-000068. Sacramento, CA.
- Cheney, P.; Sullivan, A. 2008.** Grassfires: fuel, weather, and fire behaviour. 2<sup>nd</sup> ed. Collingwood, Victoria, Australia: CSIRO Publishing. 150 p.
- Clark, T.L.; Jenkins, M.A.; Coen, J.; Packham, D. 1996.** A coupled atmosphere-fire model: role of the convective froude number and dynamic fingering at the fireline. *International Journal of Wildland Fire*. 6: 177–190.
- Clements, C.B. 1999.** Mountain and valley winds of Lee Vining Canyon, Sierra Nevada, California, U.S.A. *Arctic, Antarctic, and Alpine Research*. 31: 293–302.
- Clements, C.B.; Whiteman, C.D.; Horel, J.D. 2003.** Cold-air-pool structure and evolution in a mountain basin: Peter Sinks, Utah. *Journal of Applied Meteorology*. 42(6): 752–768.

- Clements, C.B.; Zhong, S. 2004.** The role of the topographic amplification factor in the breakup of nocturnal inversions in Yosemite Valley, Sierra Nevada. Unpublished poster presentation at the 11<sup>th</sup> conference on mountain meteorology. Boston, MA: American Meteorological Society. [http://www.met.sjsu.edu/~clements/Clements\\_Zhong\\_2004.pdf](http://www.met.sjsu.edu/~clements/Clements_Zhong_2004.pdf). (June 1, 2011).
- Clements, C.B.; Zhong, S.; Goodrick, S.; Li, J.; Bian, X.; Potter, B.E.; Heilman, W.E.; Charney, J.J.; Perna, R.; Jang, M.; Lee, D.; Patel, M.; Street, S.; Aumann, G. 2007.** Observing the dynamics of wildland grass fires: fireflux—a field validation experiment. *Bulletin of the American Meteorological Society*. 88(9): 1369–1382.
- Clements, C.B.; Heilman, W.E. 2010.** The grass fires on slopes experiment. 14<sup>th</sup> conference on mountain meteorology. Boston, MA: American Meteorological Society.
- Coen, J.L.; Riggan, P.J. 2010.** A landscape-scale wildland fire study using a coupled weather-wildland fire model and airborne remote sensing. Proceedings of 3<sup>rd</sup> fire behavior and fuels conference. [CD ROM]. Birmingham, AL: International Association of Wildland Fire. 11 p.
- Colette, A.; Chow, F.K.; Street, R.L. 2003.** A numerical study of inversion layer breakup in idealized valleys and the effects of topographic shading. *Journal of Applied Meteorology*. 42(9): 1255–1272.
- Defant, F. 1949.** Zur Theorie der Hangwinde, nebst Bemerkungen zur Theorie der Berund Talwinde. *Archiv für Meteorologie Geophysik und Bioklimatologie*, A: 421–450. (Translated as A theory of slope winds, along with remarks on the theory of mountain winds and valley winds. In: Whiteman, C.D.; Dreiseitl, E., eds. *Alpine meteorology*. PNL-5141. ASCOT-84-3. Richland, WA: Battelle, Pacific Northwest Laboratory: 95–120.)
- Dold, J. 2010.** Flow attachment in eruptive fire growth. In: Viegas, D.X., ed. *Proceedings of the VI international conference on forest fire research*. Coimbra, Portugal: Associação para o Desenvolvimento da Aerodinâmica Industrial (ADAI)/ Centro de Estudos sobre Incêndios Florestais (CEIF). 10 p.
- Dold, J.W.; Zinoviev, A. 2009.** Fire eruption through intensity and spread rate interaction mediated by flow attachment. *Combustion Theory and Modelling*. 13: 763–793.
- Doran, J.C.; Horst, T.W. 1983b.** Observations and models of simple nocturnal slope flows. *Journal of the Atmospheric Sciences*. 40: 708–717.
- Doran, J.C.; Zhong, S. 2000.** Thermally driven gap winds into the Mexico City basin. *Journal of Applied Meteorology*. 39: 1330–1340.
- Doyle, J.D.; Smith, R.B. 2003.** Mountain waves over the Hohe Tauern: influence of upstream diabatic effects. *Quarterly Journal of the Royal Meteorological Society*. 129: 799–823.
- Dupuy, J.L.; Maréchal J. 2011.** Slope effect on laboratory fire spread: contribution of radiation and convection to fuel bed preheating. *International Journal of Wildland Fire*. 20(2): 289–307.
- Durrant, D.R. 1990.** Mountain waves and downslope winds. In: Blumen, B., ed. *Atmospheric processes over complex terrain*. Boston, MA: American Meteorological Society: 59–81.
- Ekhart, E. 1944.** Beiträge zur alpinen Meteorologie [Contributions to alpine meteorology]. *Meteorologische Zeitschrift*. 61(7): 217–231. In: Whiteman, C.D.; Dreiseitl, E., eds. 1984. *Alpine meteorology*. PNL-5141, ASCOT-84-3. Richland, WA: Battelle, Pacific Northwest Laboratory: 45–72.



- Esperanza Investigation Team. 2006.** Esperanza Fire accident investigation factual report, Riverside County, California. [http://www.fire.ca.gov/fire\\_protection/downloads/esperanza\\_00\\_complete\\_final\\_draft\\_05\\_01\\_2007.pdf](http://www.fire.ca.gov/fire_protection/downloads/esperanza_00_complete_final_draft_05_01_2007.pdf). (12 December 2010).
- Forthofer, J.M. 2007.** Modeling wind in complex terrain for use in fire spread prediction. Fort Collins, CO: Colorado State University. M.S. thesis.
- Fosberg, M.A.; Schroeder, M.J. 1966.** Marine air penetration in central California. *Journal of Applied Meteorology*. 5: 573–589.
- Gaberšek, S.; Durran, D.R. 2004.** Gap flows through idealized topography. Part I: Forcing by large-scale winds in the non-rotating limit. *Journal of Atmospheric Sciences*. 61: 2846–2862.
- Hill, C.D. 1980.** The effects of terrain distribution on summer thunderstorm activity at Reno, Nevada. Tech. Memo. NWS-WR-156. Reno, NV: National Oceanic and Atmospheric Administration. 34 p.
- Horst, T.W.; Doran, J.C. 1986.** Nocturnal drainage flow on simple slopes. *Boundary-Layer Meteorology*. 34: 263–286.
- Huang, C.; Lin, Y.L.; Kaplan, M.L.; Charney, J.J. 2009.** Synoptic-scale and mesoscale environments conducive to forest fires during the October 2003 extreme fire event in southern California. *Journal of Applied Meteorology and Climatology*. 48: 553–579.
- Hughes, M.; Hall, A. 2009.** Local and synoptic mechanisms causing southern California's Santa Ana winds. *Climate Dynamics*. 34: 847–857.
- Kingsmill, D. 2000.** Diurnally driven summertime winds in the lee of the Sierra: The Washoe zephyr. Preprints, Ninth conference on mountain meteorology. Boston, MA: American Meteorological Society: 109–112.
- Kochanski, A.; Jenkins, M.; Krueger, S.K.; McDermott, R.; Mell, W. 2009.** Capabilities of current wildfire models when simulating topographical flow. *Eos Transactions of the American Geological Society*. 90(52). Fall Meet. Suppl., A41G-05.
- Linn, R.; Reisner, J.; Colman, J.J.; Winterkamp, J. 2002.** Studying wildfire behavior using FIRETEC. *International Journal of Wildland Fire*. 11: 233–246.
- Linn, R.R.; Cunningham, P. 2005.** Numerical simulations of grass fires using a coupled atmosphere-fire model: basic fire behavior and dependence on wind speed. *Journal of Geophysical Research*. 110(D13), D13107. DOI: 10.1029/2004JD005597.
- Linn, R.R.; Winterkamp, J.L.; Edminster, C.; Colman, J.J.; Smith, W.S. 2007.** Coupled influences of topography and wind on wildland fire behaviour. *International Journal of Wildland Fire*. 16: 183–195.
- Linn, R.R.; Winterkamp, J.L.; Weise, D.R.; Edminster, C. 2010.** A numerical study of slope and fuel structure effects on coupled wildfire behaviour. *International Journal of Wildland Fire*. 19: 179–201.
- Mahrt, L. 1982.** Momentum balance of gravity flows. *Journal of Atmospheric Sciences*. 39: 2701–2711.
- Manins, P.C.; Sawford, B.L. 1979.** Katabatic winds: a field case study. *Quarterly Journal of the Royal Meteorological Society*. 105: 1011–1025.
- Maranghides, A.; Mell, W. 2009.** A case study of a community affected by the Witch and Guejito Fires. Tech. Note 1635. Gaithersburg, MD: National Institute of Standards and Technology. 59 p.
- Meybeck, M.; Green, P.; Vörösmarty, C. 2001.** A new typology for mountains and other relief classes. *Mountain Research and Development*. 21(1): 34–45.
- Papadopoulos, K.H.; Helmise, C.G. 1999.** Evening and morning transition of katabatic flows. *Boundary-Layer Meteorology*. 92: 195–227.

- Porch, W.M.; Clements, W.E.; Coulter, R.L. 1991.** Nighttime valley waves. *Journal of Applied Meteorology*. 30: 145–156.
- Raphael, M.N. 2003.** The Santa Ana winds of California. *Earth Interactions*. 7: 1–13.
- Reuten, C.; Steyn, D.; Strawbridge, K.; Bovis, P. 2005.** Observations of the relation between upslope flows and the convective boundary layer in steep terrain. *Boundary-Layer Meteorology*. 116: 37–61.
- Ruscha, C.P., Jr. 1976.** Forecasting the mono wind. Tech. Memo. WR-105. National Oceanic and Atmospheric Administration.
- Ryan, G. 1994.** Climate of Santa Barbara, California. Tech. Memo. NWS WR-225. U.S. Department of Commerce, National Oceanic and Atmospheric Administration. 86 p. [Available from National Technical Information Service, U.S. Department of Commerce, Sills Building, 5285 Port Royal Rd., Springfield, VA 22161.]
- Rotach, M.W.; Calanca, P.; Graziani, G.; Gurtz, J.; Steyn, D.G.; Vogt, R.; Andretta, M.; Christen, A.; Cieslik, S.; Connolly, R.; De Wekker, S.F.J.; Galmarini, S.; Kadygrov, E.N.; Kadygrov, V.; Miller, E.; Neining, B.; Rucker, M.; van Gorsel, E.; Weber, H.; Weiss, A.; Zappa, M. 2004.** Turbulence structure and exchange processes in an Alpine Valley: the Riviera Project. *Bulletin of the American Meteorological Society*. 85(9): 1367–1385.
- Santoni, P.A.; Balbi, J.H.; Dupuy, J.L. 1999.** Dynamic modeling of upslope fire growth. *International Journal of Wildland Fire*. 9(4): 285–292.
- Schmidli, J.; Rotunno, R. 2010.** Mechanisms of along-valley winds and heat exchange over mountainous terrain. *Journal of Atmospheric Sciences*. 67: 3033–3047.
- Seto, D.; Clements, C.B. [In press].** Fire whirl evolution observed during a valley wind-sea breeze reversal. *Journal of Combustion*.
- Sharples, J.J. 2009.** An overview of mountain meteorological effects relevant to fire behaviour and bushfire risk. *International Journal of Wildland Fire*. 18(7): 737–754.
- Sharples, J.; Gill, A.M.; Dold, J.W. 2010a.** The trench effect and eruptive wildfires: lessons from the King's Cross Underground disaster. Proceedings of Australian Fire and Emergency Service Authorities Council 2010 conference, Darwin, Australia. <http://www.maths.manchester.ac.uk/~jwd/articles/10-TEaEW.pdf>. (May 13, 2011).
- Sharples, J.J.; Mills, G.A.; McRae, R.H.D.; Weber, R.O. 2010b.** Foehn-like winds and elevated fire danger conditions in southeastern Australia. *Journal of Applied Meteorology and Climatology*. 49: 1067–1095.
- Sun, R.; Krueger, S.K.; Jenkins, M.; Zulauf, A.; Charney, J.J. 2009.** The importance of fire–atmosphere coupling and boundary-layer turbulence to wildfire spread. *International Journal of Wildland Fire*. 8: 50–60.
- Taylor, S.W.; Wotton, B.M.; Alexander, M.E.; Dalrymple, G.N. 2004.** Variation in wind and crown fire behavior in a northern jack pine-black spruce forest. *Canadian Journal of Forest Research*. 34: 1561–1576.
- Vergeiner, I.; Dreiseitl, E. 1987.** Valley winds and slope winds-observations and elementary thoughts. *Meteorology and Atmospheric Physics*. 36: 264–286.
- Viegas, D.X. 2005.** A mathematical model for forest fire blow-up. *Combustion Science and Technology*. 177: 1–25.
- Viegas, D.X.; Pita, L.P. 2004.** Fire spread in canyons. *International Journal of Wildland Fire*. 13: 253–274.
- Viegas, D.X.; Simeoni, A. 2010.** Eruptive behaviour of forest fires. *Fire Technology*. 47(2): 303.

- Wagner, A. 1938.** Theorie und Beobachtungen der periodischen Gebirgswinde. *Gerlands Beiträge zur Geophysik*, 52: 408–449 (Translated as Theory and observation of periodic mountain winds. In: Whiteman, C.D.; Dreiseitl, E., eds. 1984. *Alpine meteorology*. PNL-5141. ASCOT-84-3. Richland, WA, Battelle, Pacific Northwest Laboratory: 11–44.)
- Weigel, A.P.; Chow, F.K.; Rotach, M.W. 2007.** On the nature of turbulent kinetic energy in a steep and narrow alpine valley. *Boundary-Layer Meteorology*. 123: 177–199.
- Weise, D.R.; Biging, G.S. 1996.** Effects of wind velocity and slope on flame properties. *Canadian Journal of Forest Research*. 26(10): 1849–1858.
- Weise, D.R.; Biging, G.S. 1997.** A qualitative comparison of fire spread models incorporating wind and slope effects. *Forest Science*. 43(2): 170–180.
- Whiteman, C.D.; McKee, T.B. 1982.** Breakup of temperature inversions in deep mountain valleys. Part II. Thermodynamic model. *Journal of Applied Meteorology*. 21: 290–302.
- Whiteman, C.D.; Zhong, S. 2008.** Downslope flows on a low-angle slope and their interactions with valley inversions. Part I. Observations. *Journal of Applied Meteorology and Climatology*. 47: 2023–2038.
- Whiteman, C.D. 1982.** Breakup of temperature inversions in deep mountain valleys: Part I. Observations. *Journal of Applied Meteorology*. 21: 270–289.
- Whiteman, C.D. 1990.** Observations of thermally developed wind systems in mountainous terrain. Atmospheric processes over complex terrain. *Meteorology Monographs No. 45*. Boston, MA: American Meteorological Society: 5–42.
- Whiteman, C.D. 2000.** *Mountain meteorology: fundamentals and applications*. New York: Oxford University Press. 355 p.
- Whiteman, C.D.; Pospichal, B.; Eisenbach, S.; Weihs, P.; Clements, C.B.; Steinacker, R.; Mursch-Radlgruber, E.; Dorninger, M. 2004.** Inversion breakup in small Rocky Mountain and Alpine basins. *Journal of Applied Meteorology*. 43(8): 1069–1082.
- Wu, Y.; Xing, H.J.; Atkinson, G. 2000.** Interaction of fire plume with inclined surface. *Fire Safety Journal*. 35: 391–403.
- Zangl, G. 2003.** Orographic gravity waves close to the nonhydrostratic limit of vertical propagation. *Journal of Atmospheric Science*. 60: 2045–2063.
- Zhong, S.; Li, J.; Clements, C.B.; DeWekker, S.; Bian, X. 2008a.** Forcing mechanisms for Washoe zephyr: a daytime downslope wind system in the lee of the Sierra Nevada. *Journal of Applied Meteorology and Climatology*. 47: 339–350.
- Zhong, S.; Li, J.; Whiteman, C.D.; Bian, X.; Yao, W. 2008b.** Climate of high wind events in the Owens Valley, California. *Monthly Weather Review*. 136: 3536–3552.

This page was intentionally left blank.

## Chapter 3: Critical Fire Weather Patterns

Paul A. Werth<sup>1</sup>

### Introduction

Eyewitness accounts in journals and diaries have documented the relationship between weather and large wildland fire for hundreds of years. Survivor statements after the 1871 Chicago, Peshtigo, and Michigan Fires, and the 1894 Hinckley Fire identified hot, dry, and windy conditions as the primary weather elements contributing to the destruction caused by these fires.

In the early 1900s, technological advances in meteorology permitted creditable scientific research into weather's influence on wildland fire, most of which was closely tied to the study of historical wildland fires.

Even then it was recognized that there are short periods of one or several days in every fire season when wildland fuels are unusually susceptible to large fire, and this was primarily dependent upon the weather. Show (1931) referred to these as "dangerous periods."

However, it was not until the 1960s that critical fire weather patterns, producing high fire danger and large wildland fires, were identified for both the United States and Canada.

Syverson (1962) documented the first definition of "critical fire weather patterns" as follows:

Crisis period is defined as the critical day, week or month during which blow-up fires are experienced. Further, we might conclude that the period of critical fire weather is the result of that combination of weather patterns that have given rise to this condition and might further result in causing more fires or materially assist their spread.

Current fire behavior training courses define critical fire weather patterns as: the atmospheric conditions that encourage extreme fire behavior resulting in large and destructive wildland fires.

Critical Fire Weather Patterns are defined as the atmospheric conditions that encourage extreme fire behavior resulting in large and destructive wildland fires.

Understanding weather's influence on wildland fire is essential for safe and effective fire suppression activities. Fire managers and firefighters should be aware of critical fire weather patterns in their areas and how adverse weather associated with those patterns can produce extreme fire behavior conditions that put firefighters and the general public at risk.

### Weather Elements That Promote Extreme Fire Behavior

Early fire weather research focused on individual weather elements that occurred prior to and during large wildland fires. The culmination of these studies identified four critical weather elements common to wildland fires exhibiting extreme fire behavior: low relative humidity (or low

The four critical weather elements common to wildland fires exhibiting extreme fire behavior are low relative humidity, strong surface wind, unstable air, and drought.

atmospheric moisture), strong surface wind, unstable air, and drought.

Munns (1921) found that "In months with high vapor pressure (high relative humidity), very few fires occurred,

<sup>1</sup> Paul A. Werth, Weather Research and Consulting Services, LLC, Battle Ground, WA.

while during months of low vapor pressure (low relative humidity) many bad fires occurred.” Separate studies by Hofmann (1923) in Washington and Weidman (1923) in Montana and Idaho concluded that relative humidity is the most important factor in development of dangerous forest fires because it significantly increases the flammability of forest material. In a study of southern Appalachian wild-fires, McCarthy (1924) found that relative humidity was unusually low on high fire risk days, and that this dry air was advected southward by winds from the interior of the continent. His study was also the first to connect the occurrence of low relative humidity to specific wind directions, and the warming and drying of air within high pressure systems owing to subsidence. A study of Massachusetts forest fires by Stickel (1928) stated, “Relative humidity appears to be the best single indication of forest fire hazard.” He also indicated that “The maximum forest fire hazard occurred between rainy periods, when the relative humidity is 40 percent or less.” Dague (1930) identified relative humidity of 20 percent as the point below which bad fire weather situations were created east of the Cascade Mountains in Washington and Oregon. Since that time, numerous wildland fire reports have substantiated the importance of unusually low relative humidity in the development of extreme fire behavior. Regional threshold values for low relative humidity can range between 10 and 40 percent, depending on fuel model.

Low relative humidity (low atmospheric moisture) adversely affects fire behavior by decreasing the moisture content of fine dead fuels, making them easier to ignite and carry fire. Fire line intensity (kW/m), rate of spread (m/s), and the probability of spotting significantly increase when the relative humidity is low, sometimes so rapidly that there is little advance warning.

The relationship between strong surface wind and large fires exhibiting extreme fire behavior has been well documented for hundreds of years. The first scientific research connecting the two was conducted by Beals (1914). He researched surface atmospheric pressure patterns and associated weather conditions during four large fires (1881 Michigan, 1884 Hinckley, 1902 Columbia, and the 1910

Great Idaho) and found that “The one striking feature of all large forest fires is the strong winds that prevail just before, during, and for a short period after the fire passes a given place.”

Subsequent fire weather research (Anderson 1968; Brotak 1979; Countryman et al. 1956; Dague 1930, 1934; Gisborne 1927; Goens and Andrews 1998; Hoenisch 2009; Hughs and Hall 2009; Jemison 1932; Joy 1923; Kauffman 1937; Krumm 1954; Schaefer 1957; Simard et al. 1983; USDA, USDI, and USDC 1994) has documented strong cold front, thunderstorm, and foehn winds with the occurrence of extreme fire behavior conditions. (Note: For more information concerning foehn winds, see chapter 2.) Wind affects wildland fire in a number of ways. It supplies additional oxygen to the fire, increasing fire intensity. It also preheats the fuels ahead of the fire and increases rate of spread by carrying heat and burning embers to new fuels (spotting).

Until the U.S. Weather Bureau established a national network of radiosonde stations, fire weather research was limited to studying only the effects of surface weather on fire behavior. With the advent of radiosonde data, researchers were also able to investigate the influence of upper air temperature, relative humidity, and wind on wildland fire behavior. The concept of airmass stability was discovered through the analysis of vertical temperature profiles. When temperature decreases rapidly with height, the atmosphere is classified as unstable. If there is an increase, or only a slight decrease in temperature with height, the atmosphere is classified as stable. Crosby (1949) was the first to study the effect of atmospheric stability on fire behavior. He concluded that stable air dampened convection currents over a fire, whereas unstable air increased the speed and depth of the convection currents. Brown (1950) stated that the stability of the air at the location of a fire is as important to fire behavior as temperature and humidity. Byram (1954) and Byram and Nelson (1951) studied 17 severe fires around the county and identified unstable air and certain vertical wind profiles as being favorable for extreme fire behavior. Davis (1969) investigated 70 fires in the Southeastern United



States and found that instability increases the chance of a big fire more often than low relative humidity. Haines (1988) developed a lower atmosphere severity index based on the stability and moisture content of the lower atmosphere. The drier and more unstable the airmass becomes, the higher the Haines Index, and the greater the threat of large wildland fire and extreme fire behavior. Brotak (1992–1993) found that in the Eastern United States, strong surface wind in conjunction with low fuel moisture caused more fire-control problems than unstable air. Werth and Ochoa (1990), Saltenberger and Barker (1993), and Goens and Andrews (1998) found good correlation between the Haines Index and extreme fire behavior on fires in Idaho, central Oregon, and Arizona.

In summary, unstable air amplifies the vertical growth of the smoke plume over a fire by enhancing the strength of the updrafts. This increases combustion rates by supplying more oxygen to the fire. As the height and strength of the smoke plume increases, the potential for gusty surface winds, dust devils, and fire whirls also increases. Spotting may become profuse all around the fire as large firebrands are lifted in the smoke plume. (Note: For more information concerning the effects of atmospheric stability on extreme fire behavior, see chapters 5 through 7.) Unstable air also increases the probability of thunderstorms and strong downdraft winds.

Beals (1916) defined drought as “Long-continued dry weather, especially so long continued as to cause vegetation to wither.” Beals also stated that while “Drought and periods of hot weather contribute to the fire hazard, these alone do not necessarily portend the occurrence of a great fire, as without wind an incipient fire would spread slowly.” He recognized that drought and hot weather do not necessarily result in large fires, but a critical weather element, such as strong wind, is also needed to produce a large fire. Today drought is defined as **a period of relatively long duration with substantially below-normal precipitation, usually occurring over a large area**. Drought affects fuel availability by lowering the moisture content of both live and dead fuels, making them more combustible. Drought conditions

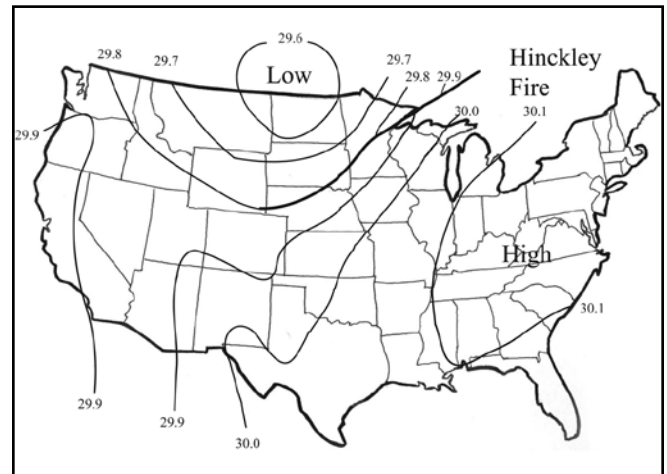

Figure 3-1—Surface pressure map 01 September 1894 at 0800 Central Standard Time. (Adapted from Beals 1914.)

are NOT a prerequisite for large fires, but there is a close relationship between drought conditions, large wildland fires, and extreme fire behavior when low relative humidity and either strong wind or unstable air are present.

### Critical Fire Weather Patterns

Critical fire weather patterns occur when atmospheric conditions combine to significantly increase the threat of destructive wildland fires that exhibit extreme fire behavior. Fire weather research has identified adverse atmospheric conditions as strong wind, unusually low relative humidity, and unstable air. Drought is also included as a significant factor, but is the result of a lack of precipitation over a period of weeks, months, or even years.

Beals (1914) researched the September 1, 1894, Minnesota Hinkley Fire in which 418 people perished. He was a pioneer in studying synoptic weather maps depicting pressure, temperature, and wind patterns associated with large fires. On the Hinkley Fire, the weather map (fig. 3-1) showed a surface low pressure center in North Dakota and tightly packed isobars favoring strong wind in Minnesota. It should be noted that his map does not depict cold and warm fronts because frontal theory was not introduced until 1917 by Norwegian meteorologists Vilhelm and Jacob Bjerknes.

Show (1931) was the first to document weather being largely responsible for dangerous fire conditions when he

wrote, "It was generally recognized that occasionally in every fire season there occurred short periods of one or several days when the forest cover was unusually flammable and at times seemed almost explosive." He concluded, "Abnormal weather conditions were responsible for these periods."

The relationship between synoptic weather patterns and high fire danger was further advanced by Schroeder (1950). He noted that for the Great Lake States in May, "Nearly all of the critical periods were associated with an area of high pressure which developed near the western shore of Hudson Bay and subsequently moved either southward or southeastward."

An early definition of a critical fire weather pattern was provided by Syverson (1962) when he described it as a "crisis period." He stated, "A crisis period is defined as: the critical day, week or month during which blow-up fires are experienced."

Syverson (1963) expanded his concept of a crisis period in an investigation of synoptic fire weather types of the Northern Intermountain, Northern Rockies, and the Northwestern Plains regions. He selected synoptic weather types (upper air 500 hPa and surface) that contributed to high fire potential or large forest fires. The 500 hPa upper air patterns were divided into meridional, zonal, short-wave train,

and high-low block categories. The surface patterns were classified according to the origin of the surface anticyclones (high pressure) affecting the area. Syverson concluded, "The greatest danger occurs just ahead of the upper trough in the area of the low pressure at the surface."

The most complete research of critical fire weather patterns was published by Schroeder et al. (1964) in *Synoptic Weather Types Associated With Critical Fire Weather*. This study covered all the Lower 48 States and determined: "Periods of critical fire weather are associated with relatively few synoptic weather patterns." They concluded that east of the Rocky Mountains, most critical fire weather patterns are associated with the periphery of high-pressure areas, particularly in the prefrontal and postfrontal areas. Along the eastern slopes of the Rocky Mountains, weather patterns producing Chinook winds are the most important. In the intermountain West, critical fire weather is associated with upper troughs and overhead jet streams, or surface dry cold front passages. Along the Pacific Coast, from Washington to California, weather patterns producing offshore flow or foehn wind are the most important.

Brotak and Reifsnnyder (1977b) detailed the relationship of Central and Eastern U.S. wildland fires with surface frontal systems and upper level troughs and ridges. They found that just prior to and after passage of cold fronts (fig.

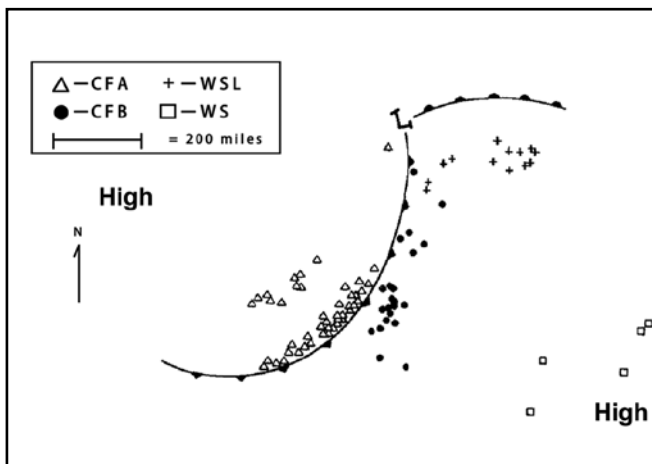

Figure 3-2—Idealized surface map showing all fire runs. CFA = following cold frontal passage; CFB = preceding cold frontal passage; WSL = warm sector of low; and WS = warm sector of high. Source: Brotak and Reifsnnyder 1977b.

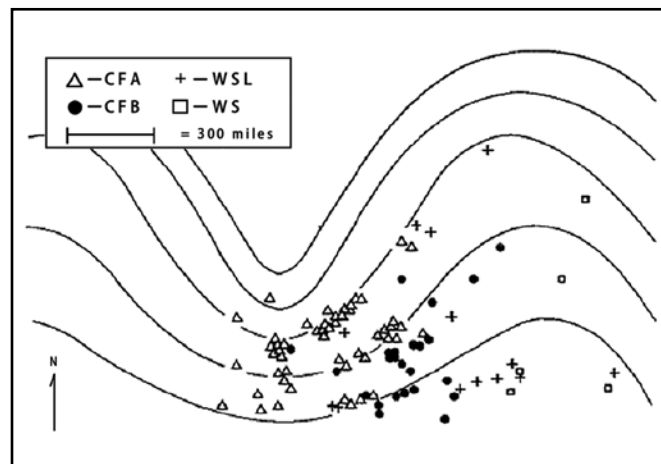

Figure 3-3—Idealized 500 hPa geopotential height map showing all fire runs. CFA = following cold frontal passage; CFB = preceding cold frontal passage; WSL = warm sector of low; and WS = warm sector of high. Source: Brotak and Reifsnnyder 1977b.



East of the Rocky Mountains, most critical fire weather patterns are associated with the periphery of high-pressure areas, particularly in the prefrontal and postfrontal areas. Along the eastern slopes of the Rocky Mountains, weather patterns producing Chinook winds are the most important. In the intermountain West, critical fire weather is associated with upper troughs and overhead jet streams, or surface dry cold front passages. Along the Pacific Coast, from Washington to California, weather patterns producing foehn wind are the most important.

3-2) were favored times for large fire growth to occur. At 500 hPa, the favored area was between the upper ridge and trough axis (fig. 3-3).

Nimchuk (1983) documented the relationship between the breakdown of a blocking upper level ridge and severe fire behavior conditions in western Canada. He concluded that the trigger for extreme fire behavior was the breakdown of the upper ridge, rather than the presence of a persistent upper ridge. His statements concerning the fire behavior associated with the three stages in the life cycle of an upper ridge are of particular interest (fig. 3-4).

1. An establishment period characterized by warm, dry stable conditions, low humidity, light wind, rapidly decreasing fuel moisture, and low lightning risk.
2. Initial weakening of upper level disturbances, leading to decreased atmospheric stability and increased lightning activity, but little or no cooling or reduction in fire danger.
3. Final breakdown, accompanied by a period of severe burning conditions, strong winds, and lightning followed by cooling and a reduction in fire danger.

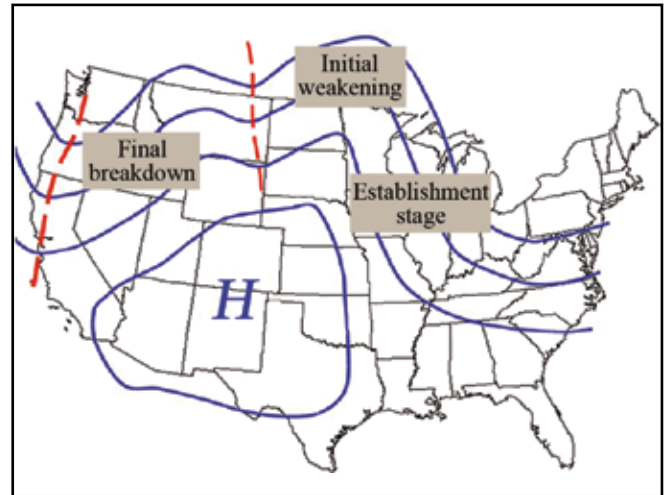

Figure 3-4—Life cycle stages of an upper level ridge.

3. Final breakdown, accompanied by a period of severe burning conditions, strong winds, and lightning followed by cooling and a reduction in fire danger.

In summary, these studies indicate that most periods of critical fire weather occur in transition zones between high- and low-pressure systems, both at the surface and in the upper air. The surface pressure patterns of most concern are those associated with cold fronts and terrain-induced foehn winds. Cold front passages are important to firefighters because of strong, shifting winds and unstable air that can enhance the smoke column or produce thunderstorms. Foehn winds occur on the lee side of mountain ranges and are typically very strong, often occurring suddenly with drastic warming and drying. The area between the upper ridge and upper trough has the most critical upper air pattern because of unstable air and strong winds aloft that descend to ground level.

### Regional Critical Fire Weather Patterns

The following section will briefly describe critical fire weather patterns by region and season. Critical fire weather patterns can be separated into two primary categories:

- Those that produce strong surface wind.
- Those that produce atmospheric instability.

In both cases, an unusually dry airmass, for the region and season, must also occur. Strong wind with high relative humidity is not a critical fire weather situation nor is unstable air combined with high relative humidity.

When critical fire weather patterns occur during periods of drought, the threat of extreme fire behavior significantly increases in brush and timber fuels. However, in grass fuels, some of the worst fire behavior has occurred in moist periods owing to increased fuel loadings. The key to identifying a critical fire weather pattern is the recognition that these patterns must also produce unusually low relative humidity for the region, along with strong surface wind or unstable air.

### Northern Plains, Great Lakes, and the Northeastern United States

The fire season in this region primarily occurs before green-up in the spring and after leaf drop in the fall. The spring season can start as early as March in the Northern Plains and the Ohio River Valley and as late as April in the Great Lakes and Northeast States. The fall season can last through November.

Critical fire weather patterns in this part of the country are identified by the source of surface high-pressure areas before or after the passage of cold fronts. That is because the source of these high-pressure areas determines the moisture content of the airmass and whether passing cold fronts will be wet or dry. There are three surface high-pressure types that can produce critical fire weather and extreme fire behavior in this region.

#### **Pacific High—**

This high pressure originates over the Pacific Ocean and loses much of its moisture as it crosses the Rocky Mountains. It moves into the Northern Plains and Great Lakes States with a dry continental airmass. This is the most common type and shows little preference for any particular month.

#### **Northwest Canadian High—**

This high pressure is normally warm and dry owing to its source region, subsidence warming, and southward

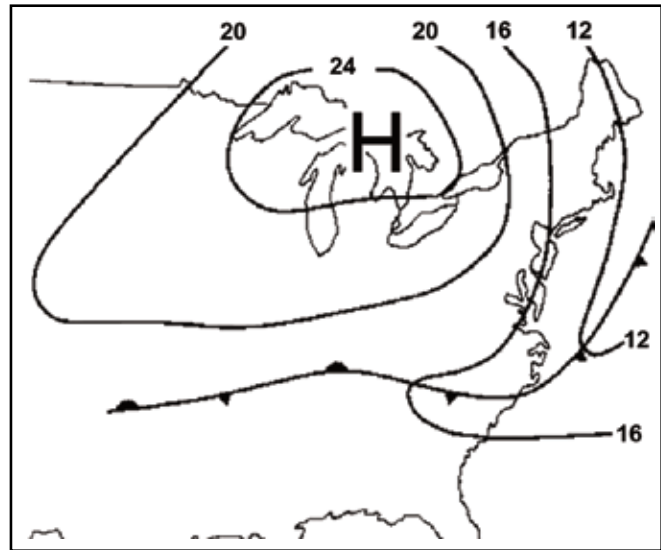

Figure 3-5—1400 Eastern Daylight Time surface weather map. Source: Brotak 1979.

movement over warmer land. Critical fire weather occurs on the periphery of the high, especially the north and northwest sides. This type occurs during the spring and fall.

#### **Hudson Bay High—**

This is similar to the Northwest Canadian High. The most critical fire weather is on the northwest side of the high. However, dry cold fronts can produce extreme fire behavior, both before and after frontal passage. Schroeder (1950) identified the Hudson Bay High as the principal weather type associated with periods of very high fire danger for the Great Lakes States.

Brotak (1979) analyzed the weather and fire behavior conditions during the July 22, 1977, Bass River Fire in New Jersey. The fire claimed the lives of four firefighters when flames overran their position. Drought, strong wind, unusually low relative humidity, and extreme instability contributed to the extreme fire behavior experienced during the fire. The extreme fire behavior occurred after the passage of a cold front and in the southeast quadrant of a Hudson Bay high-pressure area (fig. 3-5). The 500 hPa (fig. 3-6) shows an upper level trough over New Jersey and a northwesterly flow of subsiding air in the leading edge of high pressure over the Great Lakes.

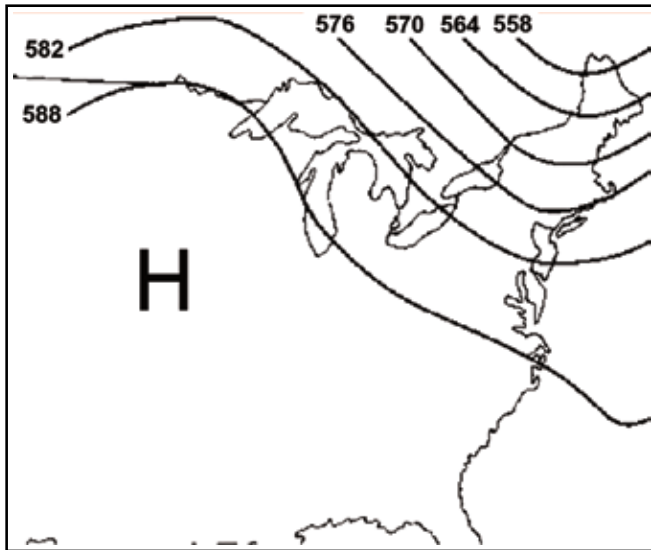

Figure 3-6—0800 Eastern Daylight Time, 500 hPa geopotential height map. Source: Brotak 1979.

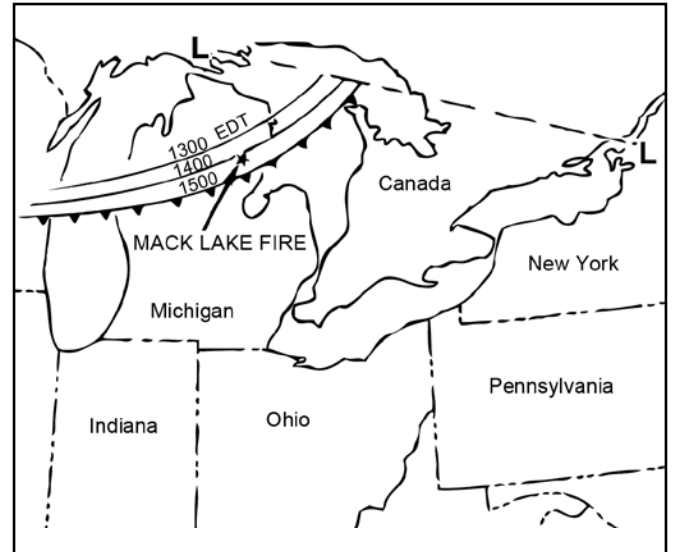

Figure 3-7—Cold frontal positions during the Mack Lake Fire. Source: Simard et al. 1983.

Simard et al. (1983) researched the weather, topography, fuels, and fire behavior of the May 5, 1980, Mack Lake Fire in Michigan. They concluded that the extreme fire behavior observed on the Mack Lake Fire occurred as follows:

“Ahead of the weak cold front (fig. 3-7), relative humidity was low at 24 percent, and the temperature was unseasonably high at 26.7 °C (80 °F). Wind-speed (at the Mio weather station) increased significantly to 24 km/h (15 mi/h), gusting to 40 km/h (25 mi/h) plus as the front approached.” This is a classic prefrontal critical fire weather pattern during the spring months for the Great Lakes States.

The August 25, 1995, Sunrise Fire on Long Island, New York, is another example of a fire that burned during a postfrontal critical fire weather pattern, with north winds and a relative humidity of less than 20 percent reported. It burned approximately 2833 ha (7,000 ac) and damaged numerous homes and small businesses.

### Southeastern United States

The Southeastern United States encompasses an area from eastern Oklahoma and eastern Texas, eastward across the lower Mississippi Valley and the Gulf States, to the Atlantic coast from North Carolina to Florida. Fire season in the

Southeast is typically during the spring and fall. However, wildland fires do occur at other times of the year. The spring fire season occurs in the weeks before green-up. This usually begins during March near the Carolina and Georgia coast and the Gulf States. The fall fire season occurs in October and November, normally after the first frost. Oklahoma and Texas are typically dry in late winter, and large grass fires are not uncommon in February. The Florida season may extend through the winter and spring well into June, especially during periods of drought. Critical fire weather patterns in this region are those that produce low relative humidity, and either strong surface wind or unstable air.

McCarthy (1923), in a study of fire weather in the southern Appalachian Mountains, observed, “Low vapor pressure (related to low dew point and low relative humidity) usually accompanies high atmospheric pressure and seems to be induced by prevailing wind from the west or northwesterly directions, while south or easterly winds tend to increase the humidity.”

McCarthy (1924) further stated, “Winds, coming from the interior of the continent and warming as they move southward, are usually low in humidity, a condition which is increased by the downward convection of cold air in

the high pressure zone which warms as it approaches the surface.”

Williams and Smith (1962) documented the weather and fire behavior associated with the March 1953 Brasstown Fire in South Carolina. They determined that the fire’s large growth and extreme fire behavior occurred after the passage of a cold front when northwesterly winds brought dry air from Canada and the Great Lakes.

Early fire case studies concluded that high fire activity in the Southeast is more often associated with surface high-pressure systems that originate in Canada or those that move across the Rocky Mountains from the Pacific Ocean. The important characteristic of these high-pressure systems is the dry air that replaces the moist Gulf of Mexico or Atlantic Ocean airmass, which normally covers this part of the country.

The movement of surface high-pressure systems is dependent upon the upper level windflow. For that reason, it is difficult to discuss critical fire weather patterns without linking the surface features to upper level pressure patterns. Three upper level patterns are effective in keeping the Southeast under the influence of high pressure at the surface. If the antecedent conditions of below normal rainfall are in place, a critical fire weather pattern emerges.

#### **Strong westerly flow—**

During the spring and fall, strong westerly winds aloft result in a rapid succession of Pacific fronts traversing the Southeast. Little, if any, moisture from the Gulf of Mexico is able to return to the region in advance of these cold fronts. Rainfall with the front is sparse and light. Exceptionally low relative humidity may occur the day after frontal passage, and little recovery can be expected before the next front arrives. Strong and gusty winds are a distinct possibility.

#### **Northwesterly flow—**

Dry air, associated with Canadian high-pressure systems, can spread across the Southeast during the spring and fall. The initial Canadian cold front moves through the Southeast and remains stationary far south of the region until the upper level pattern changes. A large and stagnant high-pressure

system settles over the region. Weak fronts from the north may reinforce the dry airmass. Relative humidity may not be quite as low as with Pacific fronts, and better humidity recovery can be expected at night. Strong northwest to north winds often occur as the surface high pressure pushes into the Southeast.

#### **Blocking ridge aloft—**

This pattern occurs when high pressure aloft persists near the Atlantic coast for an extended period of time, possibly for a few weeks. Weather systems from the west or north are blocked from moving through the region. Little or no rainfall is produced during the period that the upper level ridge is in place.

In addition to the upper level patterns, extreme fire behavior can also occur in advance of a tropical storm owing to subsidence-produced dry air and a strong wind area that extends beyond the cloud and rain shield.

Critical fire weather patterns should be carefully examined for the presence of strong low-level jets (i.e., reverse wind profile). Research conducted by Byram (1954) showed a strong connection between low-level jets and extreme fire behavior in the Southeast. (Note: For more information concerning low-level jets and adverse wind profiles, see chapter 5.)

The combination of extreme drought and critical fire weather patterns were major factors in the severe 1998 Florida wildland fire season. Fires in the northern and central portions of the state experienced major fire runs on July 4, driven by strong westerly winds and unusually low relative humidity of 30 percent or less (fig. 3-8). The source of the dry air was the Great Plains, which was pushed into Florida by a northwesterly upper level windflow (fig. 3-9).

#### **Southwestern United States**

The Southwestern region includes the states of Arizona, New Mexico, and west Texas. The normal fire season spans the months of May to October but can extend throughout the year in the grasslands of eastern New Mexico and western Texas.



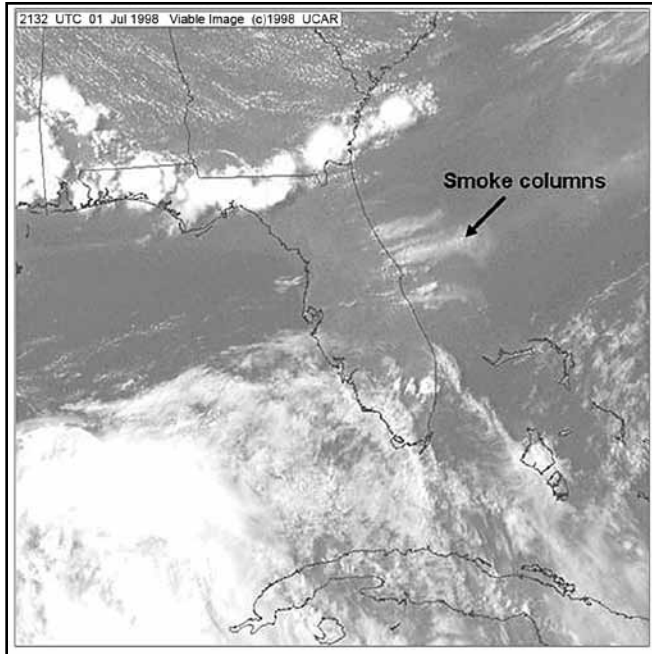

Figure 3-8—Visible satellite picture 2132 Coordinated Universal Time 01 July 1998 shows strong, dry westerly wind pushing smoke columns from central Florida wildfires out over the Atlantic Ocean. Source: National Oceanic and Atmospheric Administration and University Corporation for Atmospheric Research.

Crimmins (2005) examined the seasonal climatology of extreme fire weather conditions across Arizona and New Mexico during the period 1988–2003. He found that there are three key upper level patterns associated with over 80 percent of the extreme fire-weather days identified in this study. These upper level patterns represent broad southwest-erly flow and large geopotential height gradients and are very similar to the critical fire weather patterns identified by Schroeder et al. (1964). All three of these upper level patterns are consistent with the “breakdown of the upper level ridge” critical fire weather pattern defined earlier.

The major critical fire weather patterns of the Southwest are listed below.

#### Breakdown of Upper Ridge—

This is the most prevalent pattern in the Southwest, as a mean 500 hPa ridge is frequently positioned over the area during the fire season. From late spring through the early summer, upper level troughs moving inland from the Pacific Ocean are strong enough to temporarily push the upper ridge east and south of the area. These upper troughs are

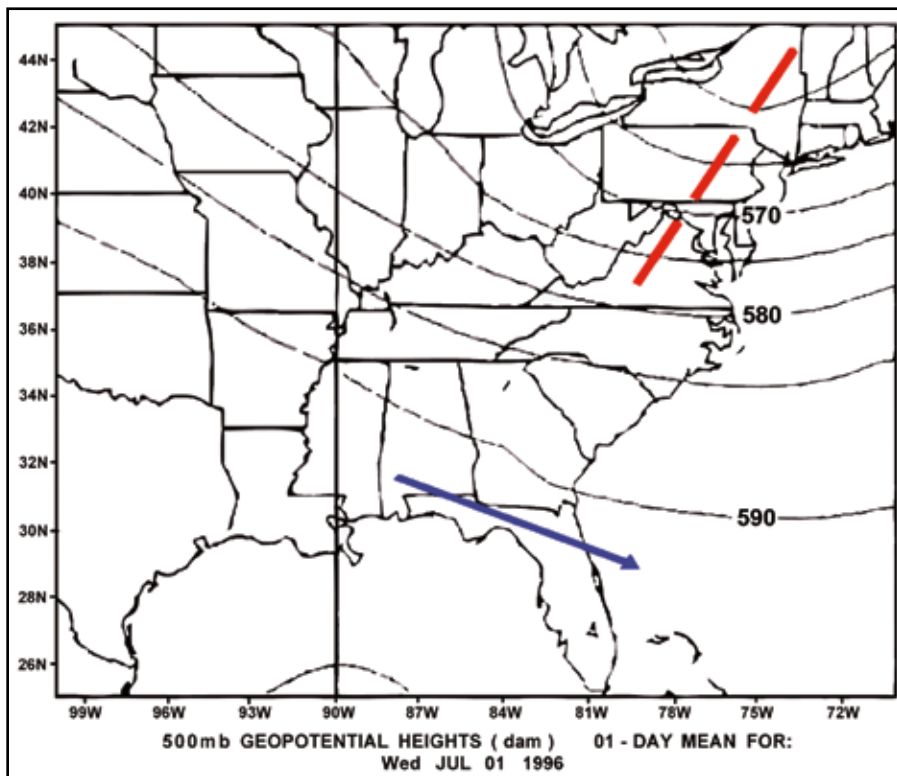

Figure 3-9—500 hPa geopotential height map indicating northwesterly flow aloft over Florida. (National Oceanic and Atmospheric Administration National Centers for Environmental Prediction/ National Center for Atmospheric Research reanalysis.)

manifest at the surface as dry, cold fronts, which produce strong winds, very low relative humidity, and isolated dry lightning. The airmass becomes unstable as the upper level trough approaches, resulting in moderate to high Haines Index values. Strong upper level winds will frequently mix down to the surface, producing winds of 64 to 80 km/h (40 to 50 mi/h). The peak fire season ends when these upper troughs stay well to the north and the southwest monsoon becomes fully developed.

#### Early Stage Monsoon—

The onset of the southwest monsoon can present an opportunity for extreme fire behavior owing to the combination of gusty wind, low relative humidity, and dry lightning-induced fire starts. As the mean 500 hPa ridge builds north in June and early July, moisture begins to increase at mid levels while surface conditions remain hot and dry. The speed and strength at which the monsoon develops determines the severity of this pattern. If the monsoon starts slowly, there may be enough dry lightning to overwhelm local fire management resources. If it develops quickly, dry storms will rapidly become rain producers and effectively end the fire season. When surface dew points rise to 10 to 15 °C (50 to 59 °F), the majority of storms will be wet.

#### Lee surface trough/dryline—

This pattern occurs in eastern New Mexico and western Texas in advance of an approaching upper level trough. Well ahead of the upper trough, a north-south dryline develops in the surface pressure pattern that sharply divides moist air to the east and dry air to the west. The passage of a dryline is similar to that of a dry cold front. Strong, gusty southwest winds develop and surface dewpoint temperatures drop from 10 to 20 °C (50 to 69 °F) to -5 to -10 °C (13 to 19 °F). This results in very low relative humidity and rapidly drying fuels. Dry, windy conditions behind a dryline can last for hours until the trailing cold front moves through with much cooler temperatures, higher relative humidity, and decreasing west to northwest winds.

The May 7, 2000, Cerro Grande Fire in New Mexico exhibited extreme fire behavior owing to a critical fire

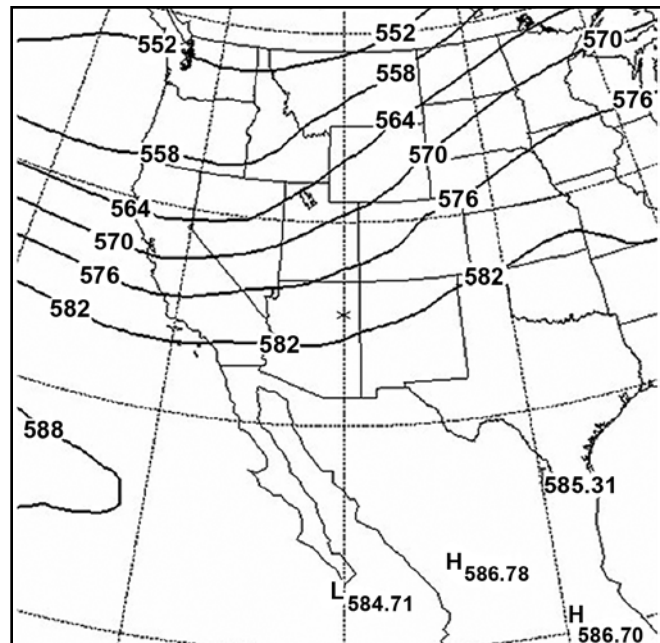

Figure 3-10—07 May 2000, 500 hPa geopotential height map. (National Oceanic and Atmospheric Administration National Centers for Environmental Prediction/National Center for Atmospheric Research reanalysis.)

weather pattern known as “the breakdown of the upper level ridge.” A strong upper level trough (fig. 3-10) was moving into Arizona and New Mexico, pushing a ridge that had been over the area into Texas and Oklahoma. Strong southwest surface winds (fig. 3-11) were experienced on the fire with gusts up to 120 km/h (75 mi/h). Drought conditions and extremely low relative humidity also contributed to the extreme fire behavior. The final size of the fire was 20 234 ha (50,000 acres) and 235 homes were burned.

#### Rocky Mountain and Intermountain Regions

These two regions cover much of the interior Western United States. The Rocky Mountain region includes the states of Montana, Wyoming, Colorado, and northern Idaho. The Intermountain region comprises the states of Nevada, Utah, and southern Idaho. The fire season ranges from May through October in the southern and June through October in the northern portions of these regions. However, in the grasslands of eastern Colorado, eastern Wyoming, and eastern Montana, it may start as early as February or March prior to green-up.



Figure 3-11—07 May 2000 visible satellite picture showing well-defined smoke plume driven by strong southwest winds. (National Oceanic and Atmospheric Administration, National Weather Service.)

A considerable amount of fire weather research has been conducted in these regions, beginning with the historic 1910 Great Idaho Fire. Beals (1914) studied this fire that burned over 809 372 ha (2 million acres) in Idaho and Montana and caused 85 fatalities. He noted, “There were many fires burning in northern Idaho, but they were kept under fair control until August 20, when a hot, high wind from the southwest began to blow. They burned so furiously that nothing could be done to stop them.”

Syverson (1962, 1963, 1964) researched and identified a number of critical fire weather patterns in the Northern Rocky and Intermountain regions as part of a “Nationwide Study of Synoptic Fire Weather Types” project spearheaded by Schroeder, Glovinsky, Hendricks, and others. He studied weather patterns on days when the fire danger was high on days of large fire activity and concluded that:

- The area of high fire danger is almost always on the southwest or west side of the high-pressure cell at the surface.
- The greatest danger occurs just ahead of the upper trough in the area of the low pressure at the surface.
- The breakdown of this fire weather type (high pressure) comes with a strong upper air impulse of cooler air moving through from the Pacific.

Syverson’s conclusions agree very well with what occurs during the “breakdown of the upper level ridge” critical fire weather pattern.

Anderson (1968) examined the weather and fire environment conditions during the September 1, 1967, major run of the Sundance Fire in northern Idaho. He found that the extreme fire behavior on this fire occurred with strong winds and low relative humidity in the prefrontal area ahead of an advancing cold front.



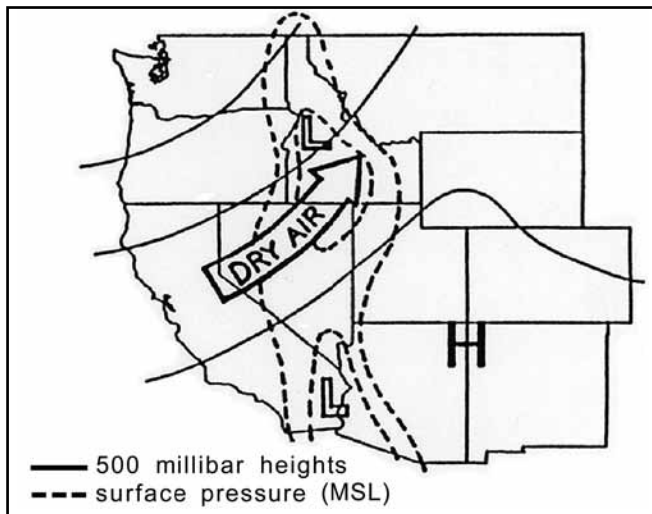

Figure 3-12—Typical 500 hPa and surface pressure pattern associated with the “breakdown of the upper ridge” critical fire weather pattern. Pattern is also favorable for moderate to high Haines Index values. MSL= Mean sea level. Source: Werth and Ochoa 1993.

Werth and Ochoa (1993) documented the weather and fire behavior that occurred on the 1988 Willis Gulch and 1989 Lowman Fires in central Idaho. The “breakdown of the upper level ridge” critical fire weather pattern was identified as significantly contributing to extreme fire behavior observed on both fires. They concluded that this pattern consisted of both upper level and surface pressure pattern components (fig. 3-12) that resulted in high Haines Index values. These index values correlated well with the rate of spread (ROS) for both fires, validating the usefulness of the Haines Index. The transition zone, between an upper level ridge and upper trough, and in an area defined by the surface thermal low-pressure trough, is a favored location for moderate and high Haines Index values.

Gibson (1996) found that the “breakdown of the upper ridge” critical fire weather pattern was present with major increases in area burned on wildland fires in the Northern Rocky region. Gibson stated, “The pattern develops as the normal upper level ridge is shoved east by an approaching shortwave trough.”

In a study of lightning-induced wildfires in Nevada, Miline (2006) found that two weather patterns account for all 17 of the major outbreaks over a 9-year sample period.

The “monsoon pattern” accounted for 7 of the 17 events and is characterized by high pressure centered over northern Utah and southern Idaho. With this pattern, warm, moist air originating in the Gulf of California is advected northward into Nevada triggering thunderstorms. The second and more significant pattern involves a negatively tilted short-wave trough moving northeastward from the eastern Pacific Ocean into north-central California and through northern Nevada and southern Oregon.

The following is a brief summary of critical fire weather patterns in the Rocky Mountain and Intermountain regions.

#### **Upper ridge-Surface thermal trough—**

This is the most significant pattern for these regions. It is characterized by a strong north-south upper ridge along 105 to 110 degrees west longitude and a hot, dry surface thermal trough extending from central California to eastern Washington or Idaho. High fire danger results when a weak mid- to upper level trough moves up the west side of the ridge, producing dry lightning in the vicinity of the thermal trough. If the upper trough is strong enough, the upper ridge will break down and the thermal trough will shift eastward across the area. A dry and windy surface cold front will then follow the thermal trough, producing very high fire danger and increasing the threat of extreme fire behavior on ongoing wildland fires.

#### **Early stage monsoon—**

This pattern occurs with an upper level ridge around 105 degrees west longitude and an upper trough off the Pacific coast. It results in dry lightning and gusty winds over the southern parts of these regions.

#### **Foehn wind/Chinook wind—**

These strong downslope winds, along the eastern slopes of the Rocky Mountains, are unusually warm and dry for the season. This pattern occurs when strong jet stream winds blow perpendicular to the mountains and the airmass is stable. They are most pronounced in the winter and spring, but can occur during the fall. When the upper level wind-flow is from the southwest, the onset of Chinook winds is

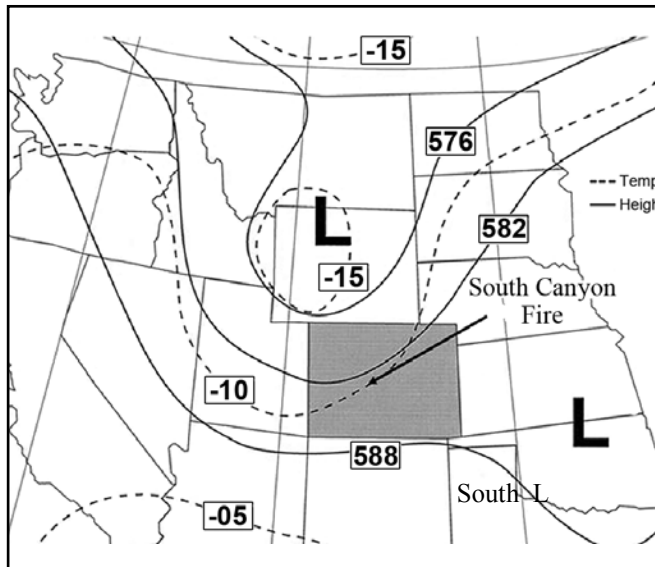

Figure 3-13—1800 Mountain Daylight Time, 06 July 1994, 500 hPa map. Source: USDA, USDI, and USDC 1994.

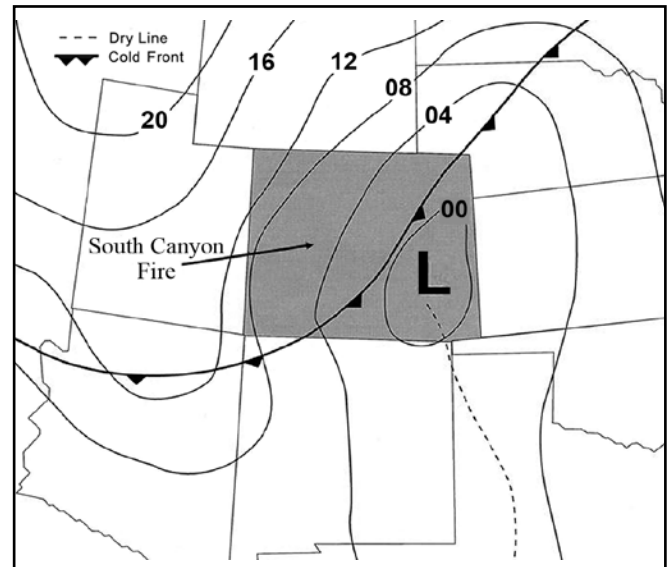

Figure 3-14—1800 Mountain Daylight Time, 06 July 1994, surface map. Source: USDA, USDI, and USDC 1994.

often prior to the passage of a weak cold front. When the flow is northwesterly, the strong wind begins after frontal passage.

The 1994 South Canyon Fire in western Colorado is a good example of a fire that burned during a “breakdown of the upper ridge” critical fire weather pattern. On the afternoon of July 6, the fire rapidly transitioned from a surface to a crown fire during the passage of a dry cold front. Tragically, 14 firefighters perished when the fire overran their position. The upper level pattern that afternoon (fig. 3-13) showed a low center in northwestern Wyoming and a trough southward along the Colorado/Utah border. This upper level system replaced an upper ridge that had been previously over Colorado. A surface cold front moved across the fire site earlier in the afternoon and at 1800 Mountain Daylight Time (MDT) was located in eastern Colorado (fig. 3-14). This weather pattern not only produced strong, gusty winds and unusually low relative humidity (<10 percent), but also very unstable air. Fuels were also especially dry owing to long-term drought.

The September 6–7, 1988, extreme fire behavior exhibited on the Yellowstone National Park (northwest Wyoming) and Canyon Creek (Montana) Fires also occurred during

a “breakdown of the upper level ridge.” An upper level trough and a strong west-to-northwest jet stream (fig. 3-15) produced winds in excess of 80 km/h (50 mi/h), unusually low relative humidity, and major crowning on both of these wildland fires. The passage of two cold fronts (fig. 3-16) added to the severity of the weather pattern. A Chinook wind developed in Montana, pushing the Canyon Creek Fire well east of the Continental Divide. Long-term drought was also a major factor.

### Pacific Northwest Region

The Pacific Northwest region comprises the states of Washington and Oregon. The typical fire season is short compared to other regions and extends from June through early October.

There are two critical fire weather patterns in this region, foehn or east winds in western Washington and western Oregon, and the “breakdown of the upper ridge” from the crest of the Cascade Mountains eastward across eastern Washington and eastern Oregon.

East winds were recognized as a fire problem west of the Cascades from the beginning of fire weather research. Beals (1914) and Joy (1923) noted that large fires west of the Cascades were caused by strong east winds that were

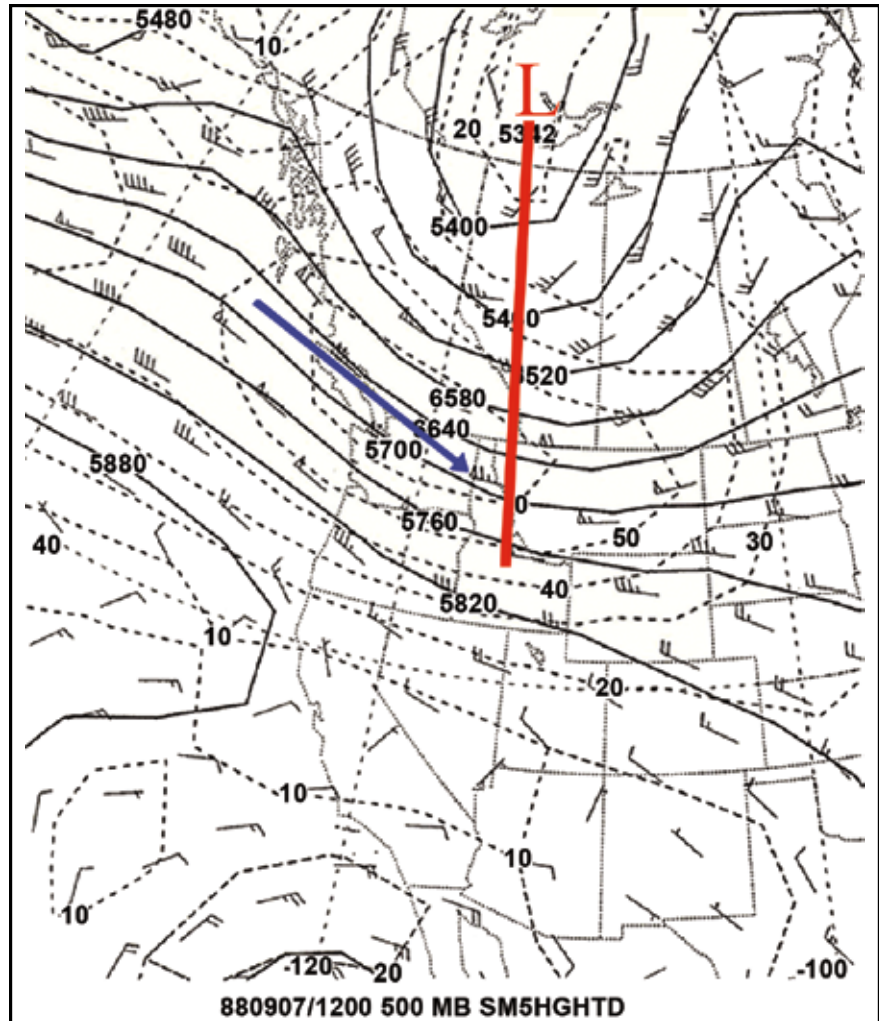

Figure 3-15—1200 Coordinated Universal Time 07, September 1988, 500 hPa geopotential height map showing a trough over Alberta, Canada, and a strong northwesterly jet stream over Idaho, Montana, and Wyoming. (National Oceanic and Atmospheric Administration, National Weather Service.)

unusually hot and dry for the area. They also noted that these strong winds occurred when there was high pressure east of the Cascades and low pressure west of the Cascades.

Dague (1934) documented weather during the August 1933 Great Tillamook Fire that burned 105 882 ha (261,640 ac) in western Oregon. He stated, “Low relative humidity, fresh to strong easterly winds, and high temperatures were responsible for this huge fire.” Dague also observed that a surface low-pressure trough west of the Cascades contributed to the strength of these winds, and the trough pushed northward from the interior of California.

Saltenberger and Barker (1993) researched weather and extreme fire behavior conditions during the August 4–5, 1990, Awbrey Hall Fire in central Oregon. They concluded

that the plume-dominated wildfire became severe owing to a combination of fuels and weather, noting, “The Haines Index performed well. When the index indicated moderate to high growth potential the fire displayed extreme behavior and rapid growth.”

In a study of lightning-induced wildland fires in the Pacific Northwest, Rorig and Ferguson (1999) discovered that there were distinctly different weather patterns between dry and wet thunderstorm days. The pattern for dry days showed an upper trough near the coast and a pronounced thermal trough at the surface in eastern Washington and eastern Oregon (near the Idaho border). Wet-pattern days show a deeper upper trough (much lower geopotential

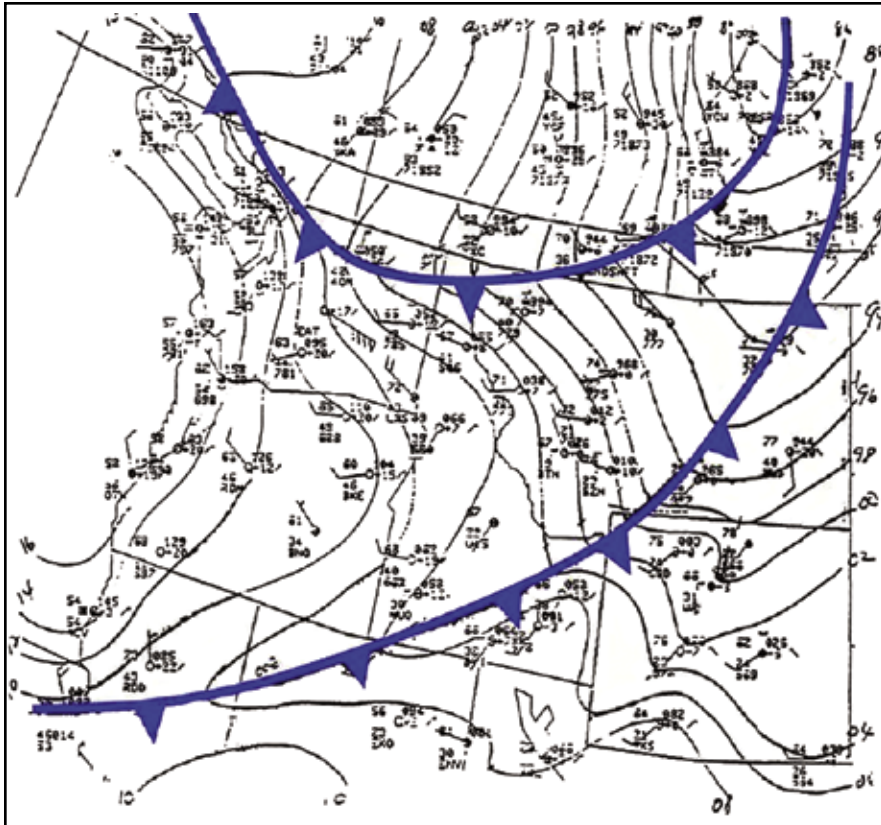

Figure 3-16—1200 Coordinated Universal Time 07, September 1988, surface pressure map showing cold fronts over northwestern Wyoming along the Canadian/United States border. (National Weather Service 1993.)

heights) and a weak surface thermal trough in southern Idaho and eastern Nevada.

Critical fire weather patterns of the Pacific Northwest are detailed below.

**Foehn wind/east wind—**

Severe east wind patterns occur when surface high pressure pushes inland behind the passage of a cold front and becomes centered over eastern Washington, Idaho, or western Montana. Meanwhile, the California surface thermal trough pushes northward along the Oregon and Washington coasts (fig. 3-17). This pressure pattern produces strong pressure differences (gradients) across western Washington and western Oregon, resulting in offshore flow and north-east-to-east winds of 80 to 97 km/h (50 to 60 mi/h) through the Columbia Gorge and the ridges and passes of the Cascade and coastal mountains. Subsidence also results in warming and drying of the airmass, and relative humidity can drop to 10 percent or lower. The combination of strong

wind and unusually low relative humidity often results in wind-driven fires and extreme fire behavior. The upper level pattern (fig. 3-18) shows a strong high amplitude ridge off the coast between 130 and 140 degrees west longitude. The east wind pattern normally ends when the upper ridge moves inland and the surface thermal trough either dissipates or pushes east of the Cascades. This pattern typically occurs during September and early October and often represents the peak of the fire season west of the Cascades.

**Upper ridge breakdown—**This is similar to the type previously described for the Rocky Mountain and Intermountain regions. In this case, the pattern is shifted farther west so the southwest flow is over Oregon and Washington. This pattern occurs when an upper level trough approaches the coast pushing the upper ridge to the east. Cooling aloft results in unstable air and an increased risk of lightning. If the airmass is dry, moderate to high Haines Index values and dry lightning are possible. The upper level winds will



Figure 3-17—East wind surface pressure pattern with a thermal trough just off the coast and a high centered over Idaho and western Montana. Pattern produces strong pressure gradients and strong winds from the crest of the Cascades to the Coast. (National Oceanic and Atmospheric Administration, National Weather Service.)

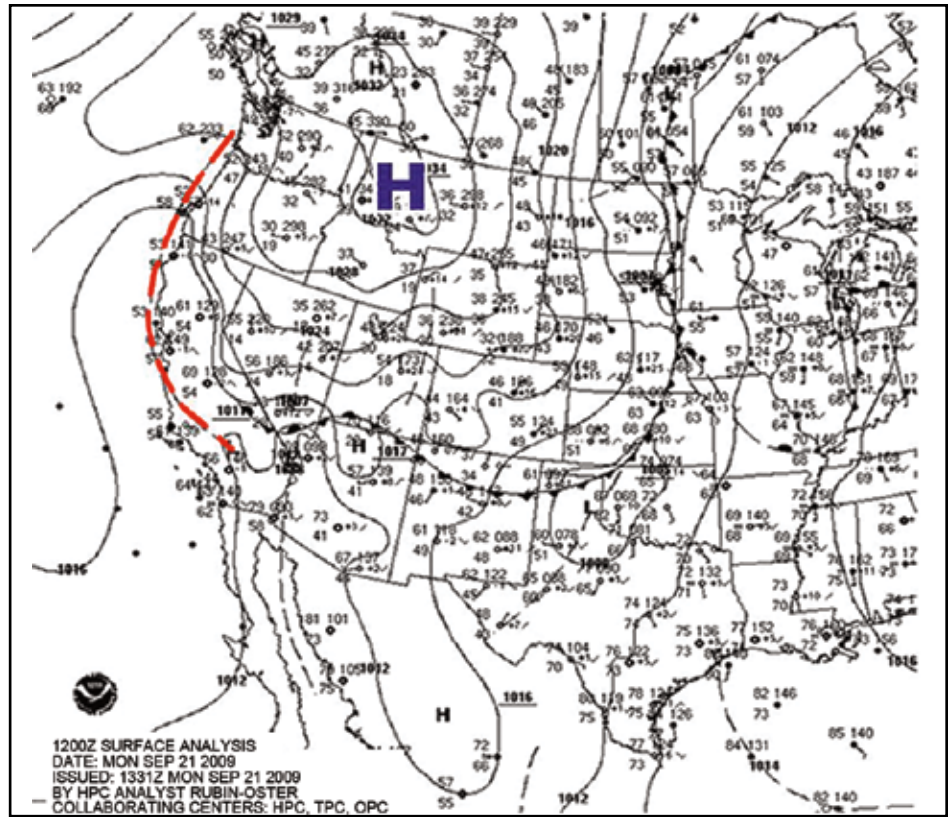
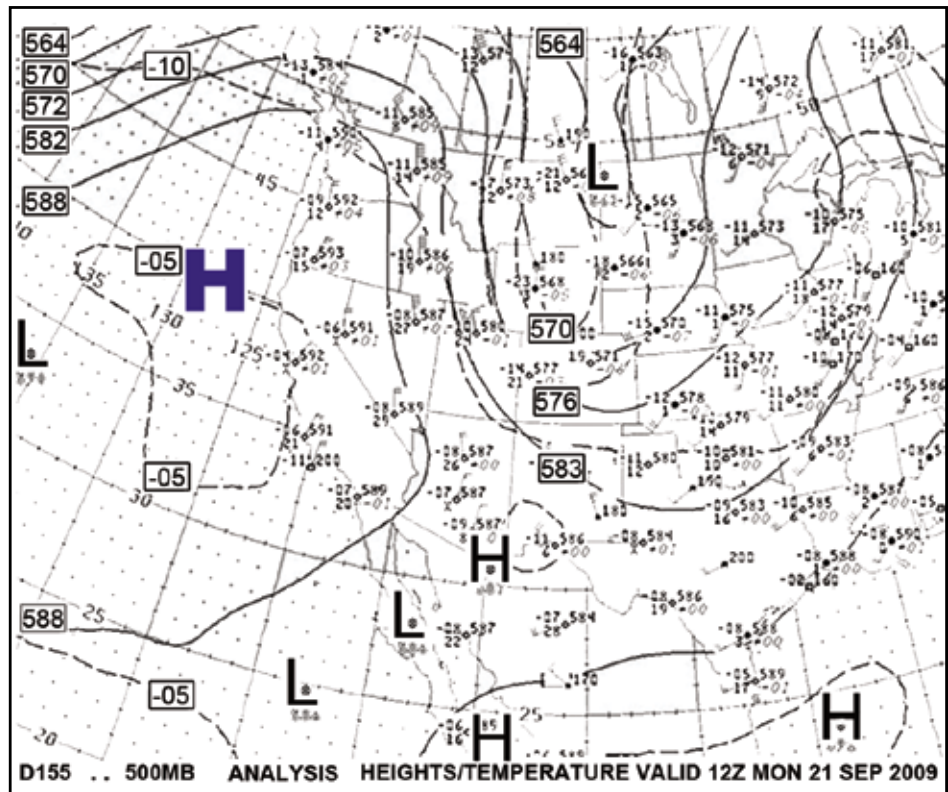

Figure 3-18—Typical east wind 500 hPa geopotential height pattern with strong ridge off the Washington and Oregon coasts. (National Oceanic and Atmospheric Administration, National Weather Service.)



frequently mix to the surface, resulting in strong gusty winds. Meanwhile, the surface thermal trough will shift eastward across the area increasing the threat of extreme fire behavior on new and ongoing wildland fires.

### California Region

The fire season extends from mid-May through October in northern California and from late March through December in southern California. However, during drought years, the season in southern California can extend throughout the year.

Krumm (1954) examined the meteorological conditions that affected the July 9, 1953, Rattlesnake Fire in northern California. Fifteen firefighters were killed on this fire. He determined that strong downslope winds occurred on the fire after sunset, caused by a strong pressure gradient between surface high pressure along the Pacific Coast and a thermal trough over the Sacramento Valley. This wind develops and descends to the surface similar to other foehn winds with low relative humidity and warm temperatures.

Weather, fuels, and fire behavior of the 1956 Inaja Fire were researched by Countryman et al. (1956) to determine what caused 11 firefighter fatalities during the fire's major run. They determined that the fire burned during a Santa Ana wind event in a very wind-prone canyon in the San Diego area.

Ortel (1964) studied serious fire weather conditions in northern and central California as part of a nationwide study of synoptic fire weather types. He identified five weather patterns of concern: an upper level high over the Southwestern States, an upper high over the Pacific Ocean, an upper trough offshore near 130 degrees west longitude, surface cold fronts, and easterly winds from surface high-pressure systems over the Great Basin.

The following is a summary of critical fire weather patterns in California.

#### **Foehn winds/north and mono winds—**

This is the most common critical fire weather pattern in northern and central California. These strong, dry winds occur when surface high pressure builds into the Pacific

Northwest, resulting in large pressure differences (gradients) across northern California. Dry air moves from Oregon southward into the Sacramento Valley with additional warming and drying. Relative humidity of 10 percent or less with temperatures of 43 °C (110 °F) can occur in the valley under these conditions. Windspeed strength depends on the pressure gradient, upper level windflow, and local topography. When the upper windflow is from the north or northeast, windspeed values in excess of 65 km/h (40 mi/h) often occur. Mono winds are strong easterly winds that occur along the western slopes of the Sierra Nevada Mountains. They are similar to the above-mentioned North winds, but in this case, the center of the surface high pressure is located in Nevada and Utah. This is primarily a late summer and fall pattern, but can occur at other times during the year if the fuels are dry.

#### **Foehn winds/Santa Ana and sundowner winds—**

This is the primary critical fire weather pattern for southern California. The pattern develops when surface high pressure builds over Nevada, Utah, and northern Arizona after the passage of an upper level trough. Meanwhile, an upper ridge of high pressure builds off the Pacific Northwest coast. North to northeasterly flow around the upper ridge results in cold air advection and strengthening of the surface high over the Great Basin. High pressure over Nevada and low pressure along the California coast result in strong pressure gradients over southern California. As a result, strong north to east winds develop from the crest of the mountains into the coastal areas. Air descending from higher to lower elevations causes compressional heating, which results in dramatic heating and drying of the air. When Santa Ana winds occur, extreme fire behavior conditions can suddenly develop as relative humidity drops to 10 percent or less and winds increase to 80 km/h (50 mi/h) or more. Winds can be substantially stronger in mountain passes and canyons. These winds are typically strongest at night and during the morning hours, and diminish somewhat during the afternoon owing to surface heating. This pattern occurs most often during the fall and winter months.

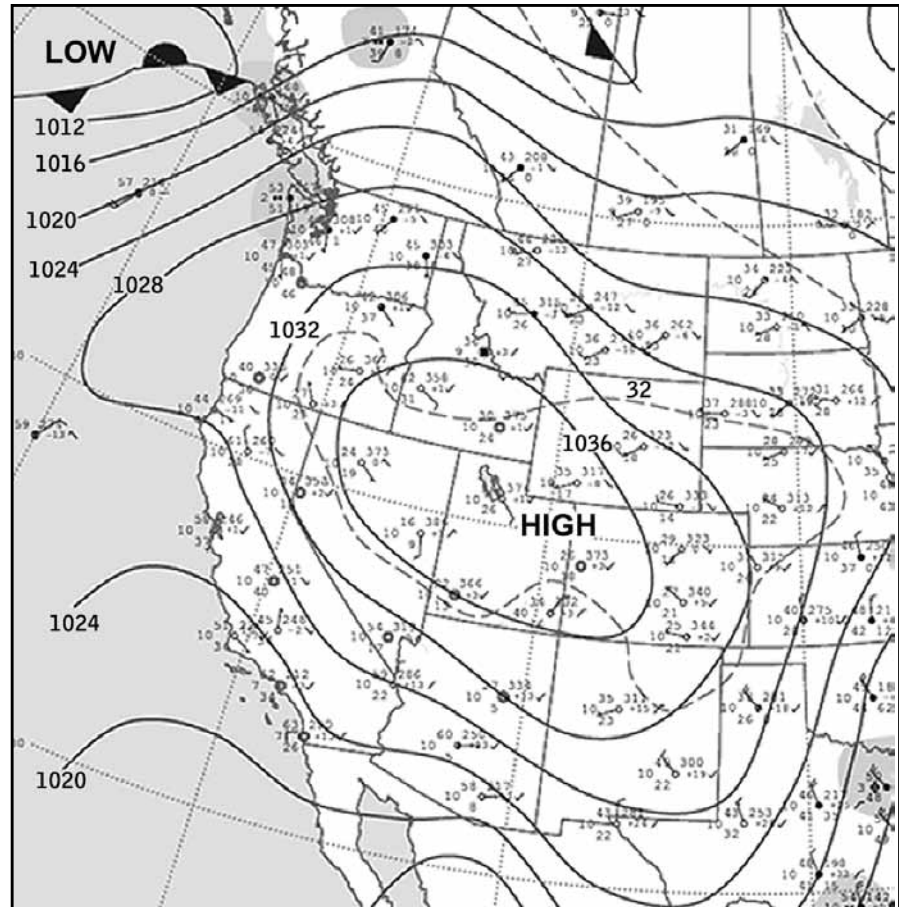

Figure 3-19—1200 Coordinated Universal Time, 22 October 2007, surface pressure map. High centered over Utah with strong pressure gradients over southern California. (National Oceanic and Atmospheric Administration, National Weather Service.)

A sundowner wind is an offshore northerly foehn wind that occurs in the lee of the Santa Ynez Mountains, which rise directly behind Santa Barbara and the surrounding coastal area. They develop when high pressure at the surface is centered over the Pacific Northwest and northern California and pressure gradients are perpendicular to the east-west axis of the Santa Ynez Mountains. These winds often precede Santa Ana events by a day or two. The normal progression is for the surface high pressure to migrate into the Great Basin causing pressure gradients and winds to shift more to the northeast and east ending the sundowner winds. (Note: For more information on Santa Ana and sundowner winds, see chapter 2.)

The October 2007 siege of wildland fires in southern California is a good example of a Santa Ana critical fire weather pattern. These massive wildfires burned hundreds

of thousands of hectares, displaced nearly a million people, destroyed thousands of homes, and resulted in 10 fatalities.

The surface and upper level pressure patterns are shown in (figs. 3-19 and 3-20). Strong surface high pressure was centered over Utah and Nevada, and an upper ridge was located off the California coast. A satellite picture (fig. 3-21) shows numerous smoke plumes being driven off the coast by northeast to east winds. Surface winds in excess of 80 km/h (50 mi/h) and relative humidity of less than 10 percent was reported on the fires.

#### **Subtropical high aloft—**

This pattern occurs when the westerlies shift northward, causing a closed subtropical high to become centered over the Southwest. The upper ridge axis extends far enough off the coast to block subtropical moisture from the area. This pattern produces heat waves in California. When a weak



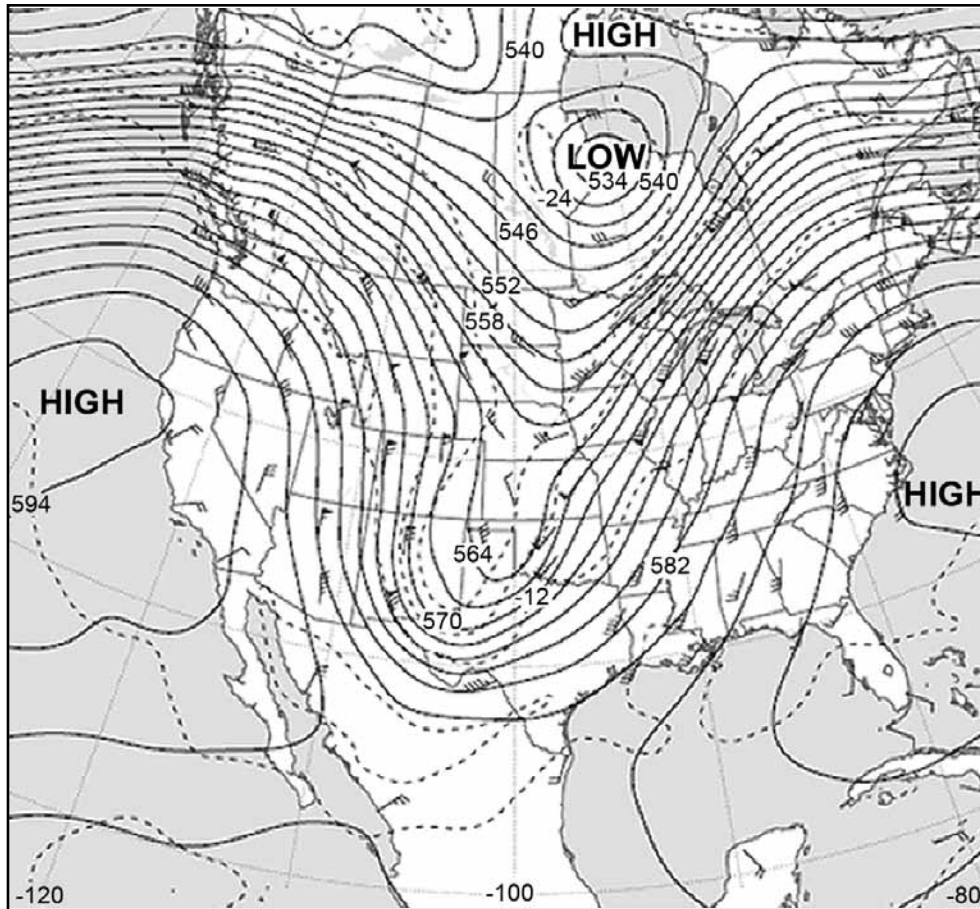

Figure 3-20—1200 Coordinated Universal Time, 22 October 2007, 50 hPa geopotential height map. A strong high was centered off the northern California coast. (National Oceanic and Atmospheric Administration, National Weather Service.)

upper trough pushes into the western portion of the upper ridge, instability can result in a significant outbreak of dry lightning (fig. 3-22).

### Alaska

The fire season in Alaska extends from May through August but is most active during June and July.

The primary critical fire weather pattern in Alaska is the “breakdown of the upper level ridge.”

#### **Breakdown of the upper ridge with southwest flow—**

This pattern occurs when southeasterly winds push moist, unstable air into the retreating upper level ridge (fig. 3-23). This can bring gusty winds and dry lightning to the interior of Alaska. The June 1998 Carla Lake Fire burned under these conditions caused by wind gusts of 56 km/h (35 mi/h) and relative humidity of less than 25 percent.

### Models and Predictive Tools

The Predictive Services Program is national in scope. It supports the wildland fire community and others with information and decision-support products. The program encompasses meteorologists and intelligence coordinators at each geographic area coordination center (GACC) and the National Interagency Coordination Center (NICC). Fire behavior or long-term analysts are detailed to GACCs during the fire season.

The following is a list of products produced by Predictive Services units that are useful in determining areas of greatest concern in relation to large fire potential and the possibility of extreme fire behavior.



Figure 3-21—22 October 2007 satellite picture showing smoke from numerous southern California wildfires blowing out over the Pacific Ocean. (National Oceanic and Atmospheric Administration, National Weather Service).

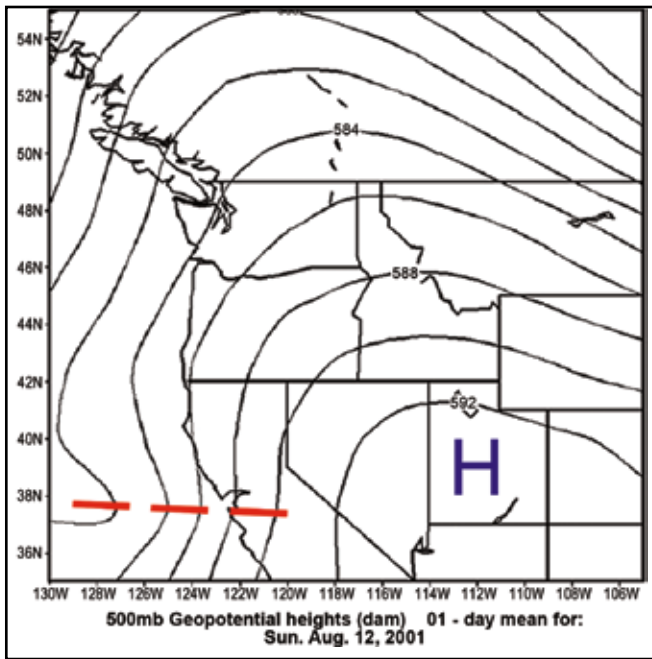

Figure 3-22—Critical California lightning pattern with subtropical 500 hPa ridge over the Great Basin and short-wave trough moving inland from the Pacific Ocean. (National Oceanic and Atmospheric Administration National Centers for Environmental Prediction/National Center for Atmospheric Research reanalysis.)

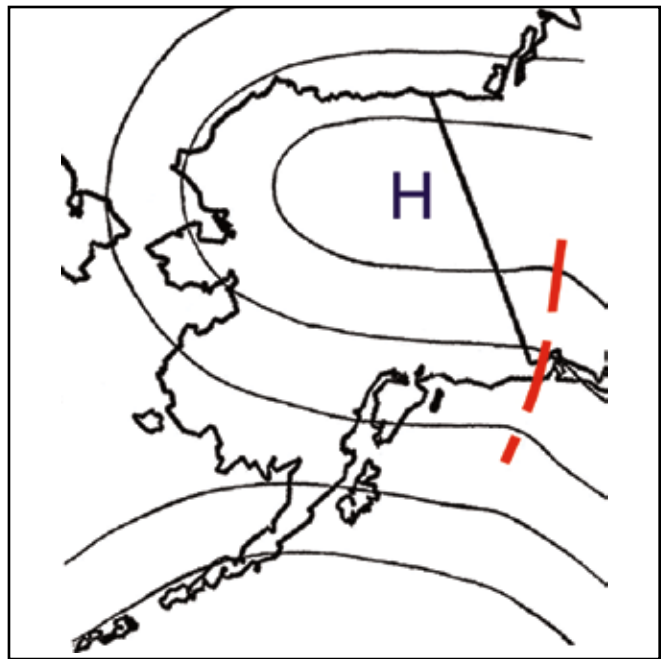

Figure 3-23—“Breakdown of the upper ridge” critical fire weather pattern in Alaska. Source: National Weather Service 1993.

## **The National Wildland Significant Fire Potential Outlook**

This product is prepared by NICC on the first business day of each month. The report consists of national maps and associated text that depict areas of below normal, normal, and above normal significant fire potential.

## **GACC 7-Day Significant Fire Potential**

This GACC product is produced daily during the primary fire season under the direction of a qualified fire weather meteorologist. The report contains projected fire weather, fuel dryness, fire danger, fire potential, and resource status information for the next 7-day period. A short discussion accompanies the report detailing weather of concern through the period.

## **Fuel and Fire Behavior Advisories**

These advisories are issued to inform fire managers and firefighters of safety concerns owing to existing or predicted fuel and fire behavior conditions.

## **Other GACC Products and Services**

The GACC Predictive Services units provide a wide variety of products and services in support of wildland fire operations. These include weather/intelligence briefings, situation reports, and resource summaries.

## **Fire Weather Watches and Red Flag Warnings**

The National Weather Service (NWS) provides fire weather products and services in support of fire management decisions. Some of the best tools in assessing the potential for critical fire weather situations are the Fire Weather Watch and Red Flag Warning program, and Spot Weather Forecasts.

Fire Weather Watches and Red Flag Warnings are issued when the combination of dry fuels and weather conditions indicate the possibility of extreme fire danger or fire behavior. These conditions alert land management agencies to the potential for widespread new ignitions that could overwhelm initial attack activities, or conditions that could cause control problems on existing fires, etc. Any of

these outcomes could pose a threat to life and property. Fire Weather Watches are issued when there is a high potential for the development of a Red Flag Event. Red Flag Warnings are used to warn of an impending, or occurring Red Flag Event. Its issuance denotes a high degree of confidence that weather and fuel conditions consistent with local Red Flag Event criteria will occur in 24 hours or less.

## **Spot Weather Forecasts/Digital Web Services**

A spot forecast is a site-specific 24- to 36-hour forecast issued to fit time, topography, and weather of a specific location. The spot forecast can be requested for wildfires, prescribed burns, spray projects, and other special projects. Other products available include FARSITE data streams and point forecast matrix forecasts from the National Digital Forecast Database. The NWS issues thousands of spot forecasts per year, and there is extensive use of digital Web services in diagnosing fire risks resulting from critical fire weather patterns.

The Storm Prediction Center's (SPC) Fire Weather program issues a daily national fire weather guidance product for use by the NWS, as well as other federal, state, and local government agencies. The product is intended to delineate areas of the contiguous United States where preexisting fuel conditions, combined with forecast weather conditions during the next 8 days, may result in a significant threat of wildfires.

There are three types of Fire Weather Outlook areas:

- Critical Fire Weather Area for wind and relative humidity.
- Extremely Critical Fire Weather Area for extreme conditions of wind and relative humidity.
- Critical Fire Weather Area for dry thunderstorms.

The SPC Fire Weather Outlook comprises a day 1 and a day 2 forecast, in addition to a day 3 through 8 forecast.

## **Summary/Knowledge Gaps**

Fire weather research has been ongoing for nearly a century, and many advances have been made during that time

concerning weather's effect on wildland fire behavior. Wind and relative humidity have been effectively incorporated into the fire behavior models. However, the effect of atmospheric stability on fire behavior is not modeled and remains subjective at best. More research is needed, beyond the Haines Index, to quantify the effects of atmospheric stability on fire behavior.

The concept of critical fire weather patterns has been in existence for 50 years. It has been successfully applied to fire case studies, but rarely has it been used in conjunction with weather forecast models to predict periods when large fires or extreme fire behavior are likely to occur.

Future research into the climatology and dynamics of these weather patterns and their effects on fire behavior would be beneficial, especially for the "breakdown of the upper ridge" pattern. Research concerning the fire behavior effects associated with the surface thermal trough also need to be better defined.

## References

- Anderson, H.E. 1968.** Sundance Fire: an analysis of fire phenomena. Res. Pap. INT-56. Ogden, UT: U.S. Department of Agriculture, Forest Service, Intermountain Forest and Range Experiment Station. 37 p.
- Beals, E.A. 1914.** The value of weather forecasts in the problem of protecting forests from fire. *Monthly Weather Review*. 42(2): 111–119.
- Beals, E.A. 1916.** Droughts and hot weather. *Monthly Weather Review*. 44: 135–138.
- Brotak, E.A. 1979.** The Bass River Fire: weather conditions associated with a fatal fire. *Fire Management Notes*. 40(1): 10–13.
- Brotak, E.A. 1992–1993.** Low-level weather conditions preceding major wildfires. *Fire Management Notes*. 53-54: 23–26.
- Brotak, E.A.; Reifsnyder, W.E. 1977a.** An investigation of the synoptic situations associated with major wildland fires. *Journal of Applied Meteorology*. 16(9): 867–870.
- Brotak, E.A.; Reifsnyder, W.E. 1977b.** Predicting major wildland fire occurrence. *Fire Management Notes*. 38: 5–8.
- Brown, A.A. 1950.** Warning signs for fire fighters. *Fire Control Notes*. 11(3): 28–29.
- Byram, G.M. 1954.** Atmospheric conditions related to blowup fires. Sta. Pap. 35. Asheville, NC: U.S. Department of Agriculture, Forest Service, Southeastern Forest Experiment Station. 34 p.
- Byram, G.M.; Nelson R.M. 1951.** The possible relation of air turbulence to erratic fire behavior in the Southeast. *Fire Control Notes*. 12(3): 1–8. (Republished in *Fire Management Today*. 63(3): 46–51.)
- Crimmins, M.A. 2005.** Synoptic climatology of extreme fire-weather conditions across the Southwest United States. *International Journal of Climatology*. 26: 1001–1016.
- Crosby, J.S. 1949.** Vertical wind currents and fire behavior. *Fire Control Notes*. 10(2): 12–15.
- Countryman, C.M.; Chandler, C.; Arnold, K. 1956.** Fire behavior: Inaja Fire disaster November 25, 1956. Berkeley, CA: U.S. Forest Service, California Forest and Range Experiment Station Report.
- Dague, C.I. 1930.** Disastrous fire weather of September, 1929. *Monthly Weather Review*. 58: 368–370.
- Dague, C.I. 1934.** The weather of the great Tillamook, Oregon, fire of August 1933. *Monthly Weather Review*. 62(7): 227–231.
- Davis, R.T. 1969.** Atmospheric stability forecast and fire control. *Fire Control Notes*. 30(3): 3–4, 15.
- Gibson, C.V. 1996.** Break-down of the Western U.S. upper-level ridge: a critical fire weather pattern. 22<sup>nd</sup> conference on agricultural and forest meteorology. Boston, MA: American Meteorological Society: 261–262.
- Gisborne, H.T. 1927.** Meteorological factors in the Quartz Creek forest fire. *Monthly Weather Review*. 55(2): 56–60.



- Goens, D.W.; Andrews, P.L. 1998.** Weather and fire behavior factors related to the 1990 Dude Fire near Payson, Arizona. In: Proceedings: 2<sup>nd</sup> symposium on fire and forest meteorology. Boston, MA: American Meteorological Society: 153–158.
- Haines, D.A. 1988.** A lower atmospheric severity index for wildland fires. *National Weather Digest*. 13: 23–27.
- Haines, D.A.; Sando R.W. 1969.** Climatic conditions preceding historically great fires in the North Central Region. Res. Pap. NC-34. St. Paul, MN: U.S. Department of Agriculture, Forest Service, North Central Forest and Range Experiment Station. 23 p.
- Hoenisch, R. 2009.** January 31<sup>st</sup> 2009 off-season grassland wildfire. Tech. Attachment. LiteTA-lite. 09-11. Salt Lake City, UT: National Oceanic and Atmospheric Administration, National Weather Service, Western Region.
- Hofmann, J.V. 1923.** Meteorological factors and forest fires. *Monthly Weather Review*. 51(11): 569.
- Hughs, M.; Hall, A. 2009.** Local and synoptic mechanisms causing southern California Santa Ana winds. *Climate Dynamics*. SpringerLink. DOI: 10.1007/s00382-009-0650-4.
- Hull, M.K.; O’Dell, C.A.; Schroeder, M.J. 1966.** Critical fire weather patterns: their frequency and levels of fire danger. Berkeley, CA: U.S. Department of Agriculture, Forest Service, Pacific Southwest Forest and Range Experiment Station. 40 p.
- Jemison, G.M. 1932.** Meteorological conditions affecting the Freeman Lake (Idaho) Fire. *Monthly Weather Review*. 60(1): 1–2.
- Joy, G.C. 1923.** Forest fire weather in western Washington. *Monthly Weather Review*. 51(11): 564–566.
- Kauffman, E. 1937.** Death in Blackwater Canyon. *American Forests*. 1937(November): 534–559.
- Krumm, W.R. 1954.** An explanation of meteorological conditions which probably caused unexpected behavior of the Rattlesnake Fire, Mendocino National Forest, July 9, 1953. 4 p. Unpublished report. On file with: National Weather Service, Pocatello, ID.
- McCarthy, E.F. 1923.** Forest fire weather in the southern Appalachians. *Monthly Weather Review*. 51(4): 182–185.
- McCarthy, E.F. 1924.** Forest fires and storm movement. *Monthly Weather Review*. 52: 257–259.
- Miline, R. 2006.** Critical lightning induced wildfire patterns for the Western Great Basin. Tech. Attachment. LiteTA-lite 06-13. National Oceanic and Atmospheric Administration, National Weather Service, Western Region.
- Munns, E.N. 1921.** Evaporation and forest fires. *Monthly Weather Review*. 49(3): 140–152.
- National Weather Service. 1993.** Critical fire weather patterns of the United States. Fire Weather Training Report. [http://www.nwccweb.us/content/products/fwxfw/publications/CRITICAL\\_FWX\\_PATTERNS\\_US.pdf](http://www.nwccweb.us/content/products/fwxfw/publications/CRITICAL_FWX_PATTERNS_US.pdf). (May 13, 2011).
- Nimchuk, N. 1983.** Wildfire behavior associated with upper ridge breakdown. Report No. T/50. Edmonton, AB: Alberta Energy and Natural Resources, Forest Service. 45 p.
- Ortel, A.G. 1964.** Weather types associated with critical fire weather conditions in Northern and Central California. Unpublished report. On file with: U.S. Department of Agriculture, Forest Service, Pacific Wildland Fire Sciences Laboratory, Seattle, WA 98103.
- Rorig, M.L.; Ferguson, S.A. 1999.** Characteristics of lightning and wildland fire ignition in the Pacific Northwest. *Journal of Applied Meteorology*. 38(11): 1565–1575.
- Saltenberger, J.; Barker, T. 1993.** Weather related unusual fire behavior in the Awbrey Hall Fire. *National Weather Digest*. 18(2): 20–29.

- Schaefer, V.J. 1957.** The relationship of jet streams to forest wildfires. *Journal of Forestry*. 55: 419–425.
- Schroeder, M.J. 1950.** The Hudson Bay high and the spring fire season in the Lake States. *Fire Control Notes*. 11(1): 1–8. (Also in *Bulletin of the American Meteorological Society*. 1974. 31(4): 111–118 as same title, slightly different text.)
- Schroeder, M.J.; Buck, C.C. 1970.** Fire weather. In: *Fire climate regions*. Agric. Handb. 360. Washington, DC: U.S. Department of Agriculture, Forest Service: 196–220. Chapter 12.
- Schroeder, M.J.; Glovinsky, M.; Hendricks, V.F. [et al.]. 1964.** Synoptic weather types associated with critical fire weather. Berkeley, CA: U.S. Department of Agriculture, Forest Service, Pacific Southwest Forest and Range Experiment Station. 492 p.
- Show, S.B. 1931.** Meteorology and the forest fire problem. *Monthly Weather Review*. 59: 432–433.
- Simard, A.J.; Haines, D.A.; Blink, R.W.; Frost, J.S. 1983.** The Mack Lake Fire. Gen. Tech. Rep. NC-83. St. Paul, MN: U.S. Department of Agriculture, Forest Service, North Central Forest Experiment Station. 36 p.
- Stickel, P.W. 1928.** Forest-fire weather in central Massachusetts. *Monthly Weather Review*. 56(4): 134–136.
- Syverson, C.E. 1962.** Prediction of the crisis period and the use of Red Flag Forecasts. Unpublished report. On file with: U.S. Department of Agriculture, Forest Service Pacific Wildland Fire Sciences Laboratory, Seattle, WA 98103.
- Syverson, C.E. 1963.** Fire weather synoptic types of the Northern Intermountain, Northern Rockies and the Northwestern Plains regions. Unpublished report. On file with: U.S. Department of Agriculture, Forest Service Pacific Wildland Fire Sciences Laboratory, Seattle, WA 98103.
- Syverson, C.E. 1964.** The meridional ridge–Pacific high, and fire weather of Northern Intermountain, Northern Rockies, and the Northern Plains. Unpublished report. On file with: U.S. Department of Agriculture, Forest Service, Pacific Wildland Fire Sciences Laboratory, Seattle, WA 98103.
- Weidman, R.H. 1923.** Relation of weather forecasts to the prediction of dangerous forest fire conditions. *Monthly Weather Review*. 51(11): 563–564.
- Werth, P.A.; Ochoa, R. 1990.** The Haines Index and Idaho fire growth. *Fire Management Notes*. 51(4): 9–13.
- Werth, P.A.; Ochoa, R. 1993.** The evaluation of Idaho wildfire growth using the Haines Index. *Weather and Forecasting*. 8(2): 223–234.
- Williams, E.B.; Smith, A.D. 1962.** Case history of the Brasstown Fire. Unpublished report. On file with: National Fire Behavior School, San Dimas, CA.
- U.S. Department of Agriculture; U.S. Department of the Interior; U.S. Department of Commerce [USDA, USDI, and USDC]. 1994.** Report of the South Canyon Fire Accident Investigation Team (SCAIT). U.S. GPO 1994-573-183 / 84023 Region No. 8. Washington, DC: U.S. Government Printing Office. 243 p.

## Chapter 4: Fire Interactions and Mass Fires

Mark A. Finney and Sara S. McAllister<sup>1</sup>

### Introduction

Some interactions of wildland fires are experienced routinely under field conditions. Firefighters and prescribed fire personnel see flames tilting toward adjacent ignition points or fire edges, particularly as the sources advance closer together (Martin and Dell 1978, Rothermel 1984). In the extreme case, interactions occurring when large areas are ignited and burning simultaneously are described as mass fires, area fires, or “fire storms” (Countryman 1964). Hundreds or thousands of individual fires may interact over an area and exhibit some “unified” behavior. Such fires are generally described as having such strong indrafts that outward propagation is minimal. They have extremely tall convection columns or smoke plumes and burn for long durations until all the fuel within the perimeter is consumed. Good reviews of mass or large area fires can be found in Williams (1982), Pitts (1991), and Heskestad (1998). Mass fires were responsible for tremendous burning rates and tornado-strength winds (Carrier et al. 1985) witnessed after the fire bombings of cities in Germany and Japan during World War II (Hewitt 1983, Schmalz 1992) and have been studied mainly in relation to consequences of nuclear attacks (Balwin and North 1967; Chandler 1963; Countryman 1964, 1965, 1969; Eggleston 1968; German 1968; Hewitt 1983; Larson et al. 1982; Larson and Small 1982a, 1982b; Lee 1969a, 1969b; Lommasson et al. 1967, 1968; Nielsen 1970; Nielsen et al. 1963; Parker 1967; Penner et al. 1986; Pryor and Yuill 1966; Quintiere 1993; Sanderlin et al. 1981; Wood et al. 1971). Many of these studies were through “Project Flambeau,” a joint effort between the U.S. Office of Civil Defense Defense Atomic Support Agency and the U.S. Department of Agriculture Forest Service in the mid-1960s. These fires were designed to mimic a suburb fire. Each square fuel bed was constructed with a mixture of pinyon pine and juniper (see “Common and Scientific Names”

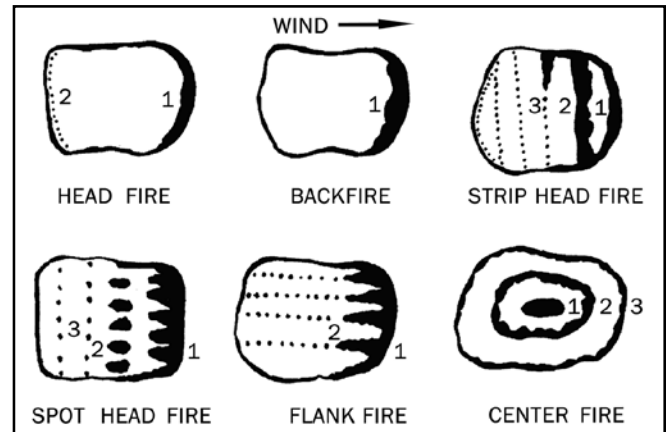

Figure 4-1—Prescribed fire ignition patterns designed to restrict or enhance fire front interactions (from Martin and Dell 1978).

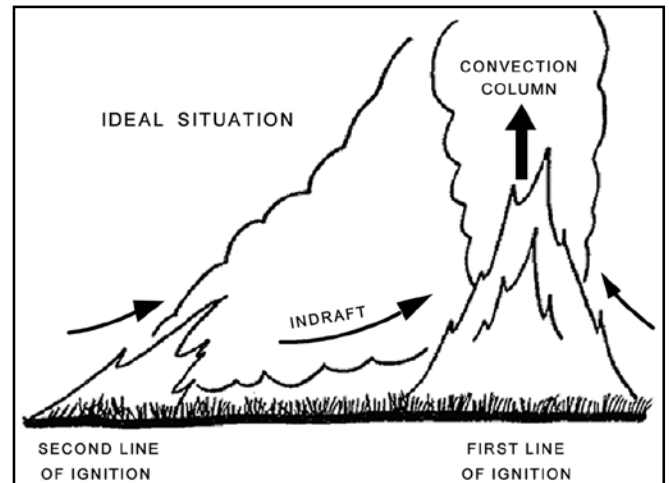

Figure 4-2—Indrafting and flame response of sequential line fires in prescribed burning (from Rothermel 1984).

section) and was approximately the same size and fuel load as a typical suburban house (185.8 m<sup>2</sup> and about 18 000 kg of fuel). The spacing between fuel beds was either 7.6 m or 35.1 m and fire sizes were 2, 6, 12, and 20 ha. Airflow velocities and temperatures were measured inside and just outside the fire area along with thermal radiation just

<sup>1</sup> Mark A. Finney and Sara S. McAllister, USDA Forest Service, Missoula Fire Sciences Laboratory, Missoula, MT.



outside the fire area, oxygen and carbon dioxide concentrations inside the fire area, and the mass loss rate of the fuel beds (Countryman 1964, 1965, 1969).

Wildland fire interactions are intentionally manipulated for ignition or firing operations (see figs. 4-1 and 4-2) to orient spread directions (Johansen 1987), to use indrafts for backfire operations (Miralles et al. 2010), to increase the development of convection columns on prescribed fires through center-firing techniques (Martin and Dell 1978), and to limit spread and intensity with spot fire ignitions (Luke and McArthur 1978, Johansen 1984, Weatherspoon et al. 1989). Rapid increases in fire growth and energy release—termed “blowup”—are sometimes associated with fire interactions (Arnold and Buck 1954). Yet, despite the common usage and practical familiarity with interactions that fire personnel often acquire, there is very little quantitative physical understanding of these behaviors and no operational models that can predict them. By comparison to other fire behavior characteristics, such as fire spread rates, fire interactions at any scale have been subject to limited study.

In this review, we endeavored to obtain literature from many sources, including wildland fire and structural fire, as well as combustion engineering and fluid dynamics, in order to cover the range of research on fire-fire interactions and the state of knowledge. Our search revealed that the topic of fire interactions overlaps considerably with other fire behaviors that are distinguished individually, such as vortices and terrain effects. These behaviors will be mentioned when appropriate, but their full discussion is beyond the scope of this review.

## Background: Time-Dependent Fire Behaviors

For a constant set of environmental conditions, fire behavior is known to change with time. These changes are not expressly considered interactions, but spread and intensity changes within individual fires are also affected during interaction among fires and may contribute to later development of interactions. Thus, such behaviors provide

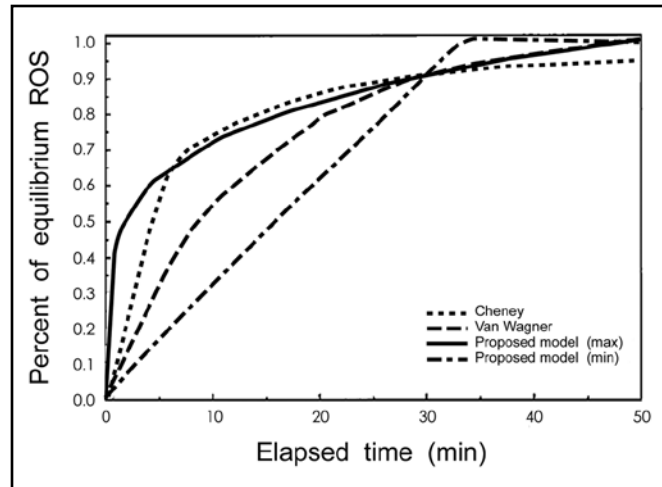

Figure 4-3—Theoretical fire spread rate acceleration curves from point-source ignitions show asymptotic increase in spread rate over time toward an equilibrium (from McAlpine and Wakimoto 1991). ROS = rate of spread.

useful background material for discussion of fire-fire interactions, although studies of fire acceleration have not directly addressed interactions of multiple fires. Many of the time-dependent changes in fire behavior are associated with fire growth or expansion in two dimensions. Changes are observed in spread rates (acceleration), frontal geometry (width, curvature), and heat transfer indicated by the orientation and size of flames. These fire characteristics are interrelated with spread processes, and the literature does not discern the causes of observable features as distinct from their probable effects.

## Fire Acceleration

Fire acceleration is defined as the time-dependent changes in spread and intensity occurring under constant weather and uniform fuel conditions. The notion of acceleration is implicitly applied to fires that are already capable of spreading as compared to combinations of threshold conditions where spread only occurs above some limit. Various mathematical representations of acceleration (fig. 4-3) have been proposed from a theoretical standpoint that express spread rate from a point-source fire as a negative exponential function of time (Cheney 1981, Cheney and Bary 1969). Parameters of these equations were fit to empirical data

from wind tunnel experiments by McAlpine and Wakimoto (1991). These functions tend toward a final equilibrium rate and are, thus, commonly communicated in terms of the time to reach some fixed fraction of equilibrium (e.g., 90 percent). A similar result was developed by Weber (1989), who represented acceleration of fires expanding as a circle from a point ignition and depended on the curvature of the fire front.

Studies of acceleration typically report time elapsed from ignition to a near-steady spread rate. Values of 20 to 30 min for point-source ignitions in slash fuels for prescribed fire conditions (McRae 1999) and in pine litter and feather moss (Kucuk et al. 2007) have been reported. Wind-driven grass fires in Australia (Albini 1982) showed large variation in acceleration times (about 6 min under slow wind conditions to over 45 min with faster winds) and a strong dependency on the width of the fire front. Wind tunnel burns of shallow (8 cm deep) pine needle and excelsior beds suggested time to equilibrium of only a few minutes (McAlpine and Wakimoto 1991) and largely independent of windspeed. Data from point ignitions in pine needle litter reported by Curry and Fons (1938) suggested windspeed affected acceleration rate (increased time to equilibrium) as well as a final spread rate. Windspeed may also affect acceleration times for conflagrations involving structures at urban densities. Chandler et al. (1963) referenced much longer time estimates than for wildland fuels, including 1 hr to achieve near-steady spread rates with windspeed up to 6.7 m/s (15 mi/h), 2 hrs for winds to 17.9 m/s (40 mi/h) and possibly much longer times for stronger winds. A long acceleration period, exceeding the 36-min observation time, was described for line ignitions in heavy fuel loadings associated with felled eucalyptus slash (McArthur 1969a) (see “Common and Scientific Names” section). By contrast, rapid acceleration to near-steady burning after line ignition was reported for experimental crown fires in jack pine forests (Stocks 1989). Implications of a theoretical analysis by Albini (1982) suggests that line ignitions in surface fuels could accelerate very rapidly, initially overshooting the steady rate, but then slow and exhibit damped oscillations

toward the steady value as the increasing vertical buoyancy of the combustion zone offsets horizontal wind force. From the existing literature, it is not clear what influences the various factors of fuel loading, fuel sizes, burning duration, and final spread rates have on acceleration time, nor more complicated interactions among multiple flame zones or heat sources.

Acceleration of fires can also occur when air inflow is asymmetrically restricted by surface topography, either in canyons (Viegas and Pita 2004), or inclined channels (Woodburn and Drysdale 1998) and slopes (Dold and Zinoviev 2009, Wu et al. 2000). Detailed treatment of these important fire-topographic interactions, however, is beyond the scope of this review of fire-fire interactions.

### Length of Fire Front

Fire acceleration and final spread rate appear to be dependent on fire size. Fires accelerate slowly from point-ignition sources (Cheney and Gould 1995, McAlpine and Wakimoto 1991, McRae 1999) relative to line-source ignitions (Cheney and Gould 1995, Johansen 1987). At the small scale of laboratory stick arrays, fuel bed width and proportion of edge on the curvature of the head fire had significant effects on spread rate (Fendell and Wolff 2001). In wind-driven grass fires, fire spread rates were found to be dependent on the length of the ignition for lines shorter than 50 to 75 m (Cheney and Gould 1995) and required longer acceleration times for higher winds (fig. 4-4). Experiments and modeling by Wotton et al. (1999) for fires in red pine litter, however, showed no increase in radiation from flames for ignition lines longer than about 2 m and no effect of line width on spread rate beyond about 1 m. Dold et al. (2006) offered an explanation for fire size effect on forward spread rate. As fires expand in two dimensions, the distance between the fire edges increases, meaning that buoyancy-induced inflow along segments of flaming front comes from a wider area. This allows ambient winds from behind the front to penetrate to the heading portion of the flame zone. Such effects on narrow combustion zones of expanding fires is presumably different than for mass fires or large-area

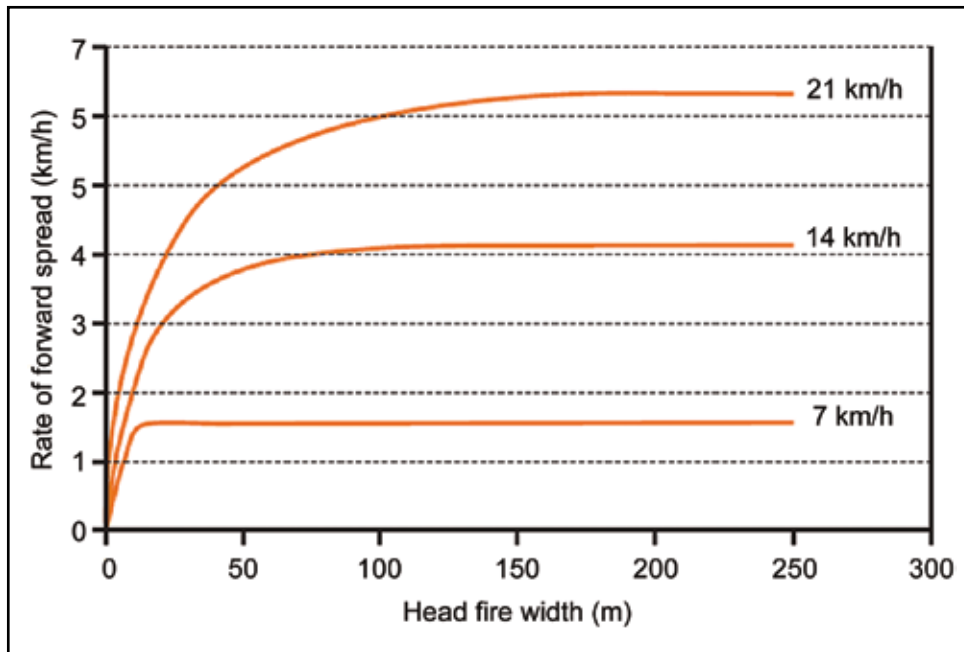

Figure 4-4—Fire spread rates in grass fuels were found to increase with the width of head fires and depend on the final spread rates determined by windspeed (from Tolhurst and Cheney 1999).

ignitions, which create indrafts from all directions (Baum and McCaffrey 1989, Smith et al. 1975), and strong buoyancy-driven convection may deflect ambient airflow around the column (Countryman 1964).

### Flame Tilt

Flame angle orientation relative to the unburned fuel is related to acceleration and is affected by fire size and stage of growth. Flames can tilt owing to wind, slope, or the interaction with other fires. Flames tilted away from the direction of spread are referred to as backing fires, and flames tilting toward the direction of spread are referred to as heading fires. Flames tilt toward the interior of the burned area in small fires or point-source fires, producing backing spread (Fendell and Wolff 2001, Luke and McArthur 1978, Tolhurst and Cheney 1999). Spread rate of backing fires spreading downslope has been shown to be only weakly diminished as slope increases (Van Wagner 1988) and little affected by wind (Beaufait 1965, McAlpine and Wakimoto 1991). Backing fires have been reported to increase fuel consumption and residence times. As fires grow larger, backing fire remains only at the rear of the perimeter (upwind or downslope) and flames for the heading

portion of the fire tilt toward the unburned fuel. The very large differences in spread rate and intensity between backing and heading fires (and flanking fires) can be estimated assuming elliptical fire shapes (Catchpole et al. 1982). Numerous studies of flame tilt angle in a wildland fuel bed on flat terrain in wind have consistently found a strong relationship to the Froude number calculated from ratios of windspeed to intensity or flame length (Albini 1981, 1982; Nelson and Adkins 1986; Weise and Bigging 1996). Similar experimental results were found using liquid pool fires (Martin et al. 1991, Pipkin and Sliepcevich 1964, Welker and Sliepcevich 1966, Welker et al. 1965) and explained as the counteraction of upward buoyant forces by crossflow, including flame trailing (lateral deflection of combustion products and flames) with high windspeeds. Recent numerical modeling (Nmira et al. 2010) has also reported Froude number relationships for both line-source and point-source simulated fires. Although slope effects were deemed significant (Weise and Bigging 1996), they are not accounted for in such formulations. When fires are in proximity, the interaction between them can change the flame tilt angle and rates of spread (Pitts 1991, Rios 1966, Welker et al. 1965). In these cases, the flame tilt angles can be correlated

with a modified Froude number that includes the separation distance of the fires (Pitts 1991, Rios 1966, Welker et al. 1965). In the case of no wind, a modified Grashof number is used (Gebhart et al. 1976, Pera and Gebhart 1975) to describe the flame tilt purely owing to flame interaction.

### **Spread Thresholds**

Thresholds describe a point of near-instantaneous acceleration that delineates when fire will and will not spread. Threshold-crossing for fire spread has been documented for many discontinuous fuel types including grasses (Marsden-Smedly et al. 2001), shrubs (Brown 1982, Burrows et al. 1991, Bradstock and Gill 1993, Weise et al. 2005), and trees (Bruner and Klebenow 1979, Van Wagner 1977). Laboratory-scale fires reveal similar spread thresholds in arrays of small sticks (Beer 1995, Vogel and Williams 1970, Weber 1990) and taller beds of excelsior (Finney et al. 2010). These studies reveal threshold dependencies on multiple environmental, fuel, and fire variables, such as windspeed, fuel moisture, slope, horizontal fuel gap dimensions, fuel bed depth, fuel combustion rate, and flame size. Chandler (1963) proposed combinations of ranges of windspeed, humidity, and rainfall by fuel type to define spread thresholds for significant growth of large fires. Recent studies of fire spread sustainability provide empirical evidence on the importance of fuel moisture, wind, and fuel loading (Beverly and Wotton 1997, Leonard 2009). As described in later sections of this chapter, fire interactions exert strong influences over many of these same environmental and fire variables and, thus, may elicit threshold-crossing spread for fires burning in discontinuous fuels.

### **Conditions Where Fire Interactions Occur**

Interactions are possible when many separate fires grow together or multiple segments of a single continuous fire are oriented in proximity. In natural wildland fires, multiple fronts often occur because of spotting from a single main fire. Spot fires are relatively common under dry and windy conditions and even long-distance spotting contributes to fire movement (Anderson 1968). But massive deposition of

firebrands at relatively short distances from the fire front (a few kilometers) can substantially increase spread rate and create simultaneous area ignition (Cheney and Bary 1969). On wildfires, Cheney and Bary observed that the highest concentration of fire brands fell within a fan-shaped zone about 9 degrees in angle on either side of the primary wind direction and theorized that mass fire behavior could be achieved for certain unspecified combinations of fire brand density and acceleration time for individual ignitions. Johansen (1984) made similar observations for spot ignition patterns on prescribed burns where higher spot densities increased the numbers and frequencies of junction or merger zones. The increase in intensity at such junction zones have been documented empirically (Johansen 1984, McRae et al. 2005) and modeled (Morvan et al. 2009) leading to recommendations for wide separation of ignitions (Marsden-Smedley 2009, Tolhurst and Cheney 1999) unless area ignition is desired (Taylor et al. 1973). Mass ember deposition and area ignition has been documented by McArthur (1969b) for Tasmanian fires, which resulted in near-simultaneous ignition of hillsides. A similar process was proposed for the Air Force Bomb Range Fire (Wade and Ward 1973), which periodically caused area ignition ahead of the main front and vertical development of a convection column. Modeling by Weihs and Small (1986) showed that interactions between large mass fires can even cause these typically nonspreading fires to propagate toward one another.

How close together fires must be before flames visibly interact and subsequently merge is not clear. There have been many empirically derived merging criteria in the literature. Correlations exist for the critical parameters for both flame interaction (Baldwin 1968, Liu et al. 2007, Sugawa and Takahashi 1993) and merging (Delichatsios 2007, Fukuda et al. 2004, Putnam and Speich 1963, Wood et al. 1971). These correlations take many forms—some define a critical ratio between the fire spacing and fire diameter (Sugawa and Takahashi 1993, Wood et al. 1971) or flame height (Baldwin 1968, Delichatsios 2007, Liu et al. 2007), some define a critical ratio between the flame height and

fire diameter (Wood et al. 1971), and some define a critical dimensionless heat release rate (Fukuda et al. 2004, Putnam and Speich 1963). Upon close examination, however, it becomes clear that fire spacing, fire diameter, flame height, and dimensionless heat release rate have interdependencies, and, thus, these different correlations are not necessarily contradictory. The discussion here will focus on the relations between spacing, diameter, and flame height because they are the most intuitive.

Using both gas diffusion burners and pool fires, Sugawa and Takahashi (1993) reported that flames begin to interact when the ratio of the spacing distance to the fire diameter is less than four. In other words, flames can interact, here defined as visually tilting, over distances four times their diameter, Baldwin (1968) considered the onset of flame interaction in terms of flame height. Flames were considered to be interacting if the flame heights increased more than 10 percent above the independent flame height. Using square and round gas burners, wood cribs, and large timber yard fires, Baldwin (1968) (and Baldwin 1966, Baldwin et al. 1964, Thomas 1968) correlated experimental data over a wide range of scales and configurations found in the literature and determined that the flames would interact if the spacing were less than 0.22 times the flame length. For a characteristic dimension  $D$  and height  $L$ , this correlation holds for  $1 < L/D < 300$ . Liu et al. (2007) also found the same dependency but with a slightly different constant of proportionality for merging of round pool fires. In their experiments, flame merging was likely to occur when closer than 0.29 to 0.34 times the merged flame length. Delichatsios (2007) also found that flames began to merge at spacing less than 0.33 times the actual flame length for gaseous burners. The discrepancy in these constants may be due to different definitions of flame interaction (tilting versus change in flame height) and flame merging (using completely merged flame height versus actual flame height), different fuels, and possibly uncertainty of measuring flame dimensions. In comparing the results of the Project Flambeau fires to those using a sand-filled pan burner, Wood et al. (1971) reported that flames merged if the flame height

was at least half of the fire diameter. Heskestad (1998) clarified that this occurs when the nondimensional group  $N \sim Q^2/D^5$  is near  $10^{-5}$  ( $Q$  is the heat release rate and  $D$  is the fire diameter). Clearly there is no definitive criterion for when flames begin to interact and merge, and these relations will remain qualitative guidelines until there is some sort of unifying theory.

An opposing effect may occur with area fires over large homogenous fuel beds (small flame height compared to fire diameter). For a sufficiently large fuel bed, it may be impossible for a continuous flame to exist over the entire bed. Instead of one continuous flame, the fire may break up into many distributed flamelets (Countryman 1969, Heskestad 1991, Wood et al. 1971). Heskestad (1991) showed that the breakup of continuous flames occurs when the nondimensional group  $N \sim Q^2/D^5$  is near  $10^{-6}$ . The convection column for these cases has been described as having two modes: Bénard cell convection near the surface, which then merges and transitions to a more organized convective plume (Fosberg 1967).

## Specific Effects of Fire Interaction

Studies of fire interactions involve specific types of behavior of the combustion and observable fire characteristics. Much of the research on these behaviors comes from laboratory experiments with artificial fuel sources and attempts to isolate the particular response of interest.

## Burning Rate

When fire fronts are close enough to interact and merge, such as in a mass fire, the mass of fuel burned as a function of time, or burning rate, of the fire can change dramatically. Much of the research on fire interactions has been done using gas burners with a fixed burning rate, but there has been some work on the interaction of flames over liquid pool fires and wood crib fires. Although the geometry and heat transfer mechanisms inside the fuel bed are different, liquid pool fires are much like fires burning over solid fuel in that the heat transfer from the fire back to the fuel controls the burning rate. In contrast, the burning rate of a



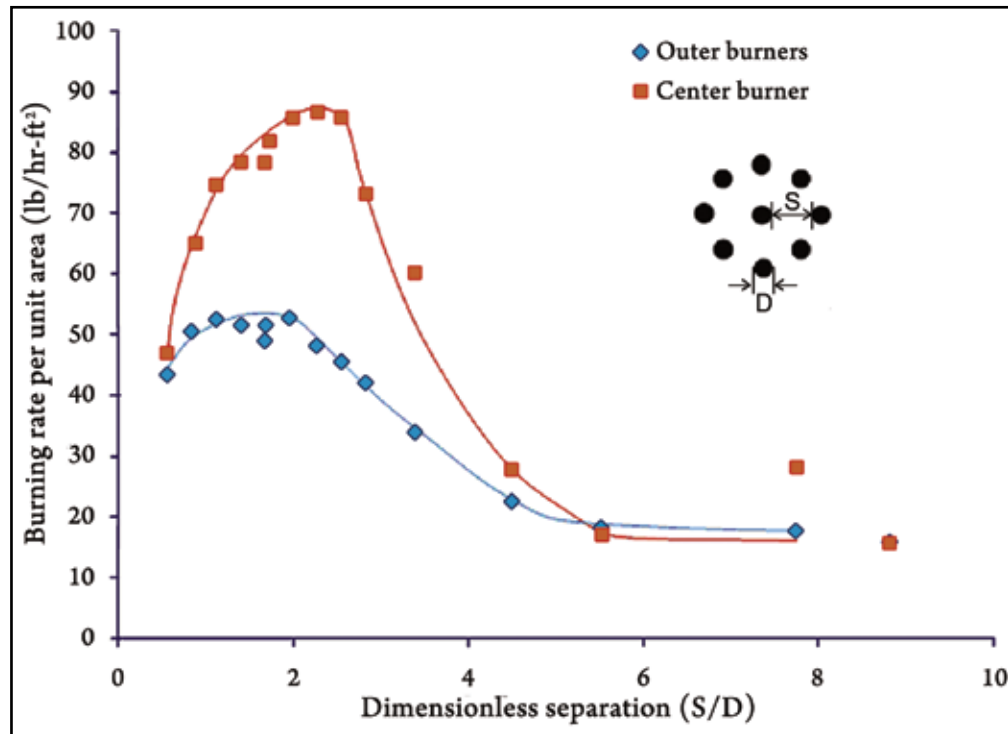

Figure 4-5—Burning rate as a function of separation distance for 10.1-cm-diameter cyclohexane burners (from Huffman et al. 1969).

gas burner is controlled by using a fixed fuel supply rate. Results from pool and crib fire experiments can often be extended to larger fuel beds using appropriate scaling laws (Emori and Saito 1983).

The experiments by Huffman et al. (1969) clearly reveal the effect of spacing on the burning rate of pool fires. In this work, the burning rate of an array of liquid pools was measured while keeping a constant fuel depth and varying the number of pools, pool diameter, fuel, and pool separation distance. In general, the burning rate of each individual pool burner increases as the burners are brought closer together and the flames began to interact. In particular, the pools in the middle of the array show a very dramatic increase. For example, figure 4-5 shows that the burning rate of 4-inch (10-cm)-diameter pools of cyclohexane experienced over a 400 percent increase in burning rate when the separation distance was halved. At the onset of flame merging, the burning rate is at its maximum. As the flames merge, the burning rate decreases as the separation

distance continues to decrease. In the limit of zero separation distance, however, the burning rate of the individual fires is still larger than if they were burning independently with no interaction effects. These trends were also seen by Grumer and Strasser (1965) with solid fuel beds.

Kamikawa et al. (2005) studied the effect of flame merging on heat release rates (heat released per time). Heat release rate is calculated by multiplying the burning rate (mass of fuel burned per time) by the heat of reaction (heat released per mass of fuel burned). However, the heat of reaction is dependent on the fuel and the mixture ratio of fuel to air. In large fire arrays, the inner regions of the array typically experience a shortage of air. Without sufficient air, the fuel cannot completely react and release the full potential heat, i.e., the combustion efficiency is low and less heat is released per mass of fuel. Not surprisingly, Kamikawa et al. saw the same trend with heat release rates as Huffman et al. (1969) with burning rates. When the flames are merged, the heat release rate increases with separation distance.



As the burners are moved farther apart, more air can penetrate into the inner regions of the array. More air entrainment means greater combustion efficiency and greater heat release. This, in turn, heats up and evaporates the unburned fuel more quickly, increasing the burning rate.

Liu et al. (2009) explained the mechanisms behind these trends in burning and heat release rate with separation distance. The non-monotonic behavior seen in figure 4-5 is the result of two competing mechanisms: heat feedback enhancement and air entrainment restriction. As the burners are moved closer, the view factor between neighboring fires increases. In other words, the fires can “see” each other better, increasing the radiative heat transfer in addition to the convective heat transfer (Grumer and Strasser 1965). Because the burning rate is dictated by the heat feedback from the flame, this increased radiative heat seen by the fuel will evaporate the fuel more quickly and increase the burning rate. Conversely, as the fires get sufficiently close, there is less room to entrain air inside the array and the flames become “choked.” When the flames are merely interacting, the heat feedback mechanism is more important than the air restriction and the burning rate increases. When the flames have merged, the air restriction is the dominant mechanism and the burning rate decreases.

Because the experiments by Kamikawa et al. (2005) used wood crib fires, they were also able to examine the release rate as a function of time for merged flames. As with most wildland fires, the heat release rate (and burning rate) of wood crib fires increases as the fire builds, reaches a maximum, then begins to decrease as the fuel is depleted. Kamikawa et al. (2005) made the observation that as the number of fires increases, the peak heat release rate increases above that expected by multiplying the independent fire heat release rate by the number of fires. This discrepancy grows as the number of fires increases. So the burning and heat release rates of interacting and merging fires not only are dependent on the spacing of the fires, but also on the total number of fires (see also Liu et al. 2009).

Fire interactions can increase burning rates by another mode as well. If the fires interact such that vorticity is gen-

erated, fire whirls can form. Although not discussed further here, it has been shown that fire whirls have dramatically increased burning rates in comparison to an equivalent, nonrotating fire (see e.g., Emmons 1965, Grishin et al. 2004).

## Flame Dimensions

Flame height trends for a non-premixed flame, such as those in a wildfire, are usually discussed in terms of two dimensionless parameters: the dimensionless flame height and the dimensionless heat release rate. The dimensionless flame height is usually defined as the flame height divided by the characteristic burning area diameter ( $D$ ). The characteristic burning area diameter is a dimensioned parameter frequently introduced in fire arrays and is usually some function of the number of fires, fire diameter, and the fire arrangement (separation distance). The dimensionless heat release rate ( $Q^*$ ) is usually defined as the total heat release rate of the group divided by the characteristic burning area diameter to the five-halves power (material property constants are used to make the ratio dimensionless:  $Q^* \sim Q_{tot}/D^{5/2}$ ). The dimensionless heat release rate for natural fires tends to fall between 0.05 and 5 (McCaffrey 1995).

Much of the research on flame height has been performed using gas burners. However, two regimes of flow from a gas burner can be identified. When the flow velocity is low or the burner diameter is large, the momentum of the gaseous fuel is due primarily to its buoyancy. When the flow velocity is high or the burner diameter is small, the flow is like a jet. Putnam and Speich (1963) have a method for determining whether the flow from a gas burner is a high-momentum jet or buoyancy controlled. The discussion here will be limited to turbulent, buoyancy-driven flames, as this situation better describes what occurs during a wildfire.

In general, the flame height increases as the fires are moved closer. When the flames begin to merge, the flame height will dramatically increase with further decreases in separation distance. However, once the flames are fully merged, further decreases in separation distance will have little effect (Chigier and Apak 1975, Fukuda et al. 2004,

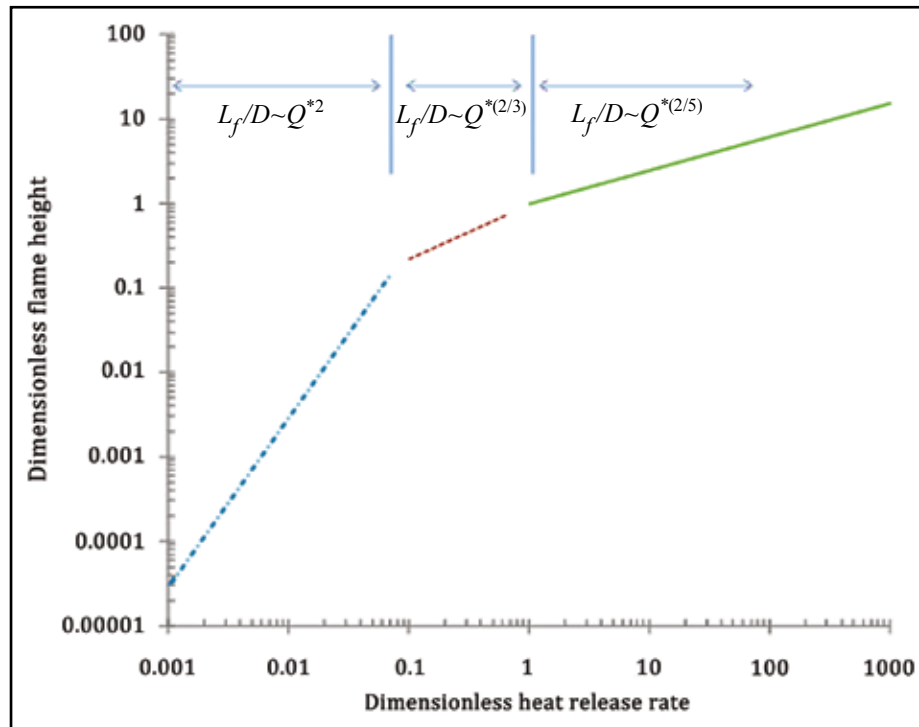

Figure 4-6—Dimensionless flame height ( $L_f/D$ ) correlations with dimensionless heat release rate ( $Q^*$ ) (Quintiere and Grove 1998).

Putnam and Speich 1963). The dimensionless flame height has successfully been correlated to the dimensionless heat release rate raised to some power,  $a$ . Because the dimensionless heat release rate can range over at least seven orders of magnitude, this power “ $a$ ” can take on three different values depending on the range of the dimensionless heat release rate. As shown in figure 4-6 (Quintiere and Grove 1998), the dimensionless flame height increases with the dimensionless heat release rate. These correlations were originally developed for the flame height of a single independent burner where the characteristic dimension is the burner diameter, and hold for buoyancy-driven gas burners, liquid pool fires, and wood crib fires. However, there is an indication that these correlations also apply to interacting flames when the characteristic burning area dimension is given as discussed above. For example, for the interaction of relatively tall flames compared to the actual burner diameter ( $L_f/D > 1$ , or high values of  $Q^*$ ), Putnam and Speich (1963) and Sugawa and Takahashi (1993) showed that the dimen-

sionless flame height correlates well with the dimensionless heat release rate to the two-fifths power ( $L_f/D \sim Q^{*2/5}$ ). Delichatsios (2007) successfully correlated the dimension 2.5 two thirds power ( $L_f/D \sim Q^{*2/3}$ ) for  $Q^*$  between 0.1 and 1. On the other hand, Weng et al. (2004) and Kamikawa et al. (2005) showed that the data for merged flame height is better correlated with the exponent “ $a$ ” varying with the number of burners.

With all else remaining constant, these correlations suggest that an increase in either the number of fires or the individual fire heat release rate will increase the interacting or merged flame height. Increases in the separation distance or the fire diameter will result in a decrease in the interacting or merged flame height. An interesting caveat to these correlations is that the burning rate for individual pool or crib fires is not constant, but is a function of the separation distance as discussed above. This trend is not necessarily captured in figure 4-6 or by Putnam and Speich (1963) (gas burners), Kamikawa et al. (2005), Fukuda et al. (2004), or

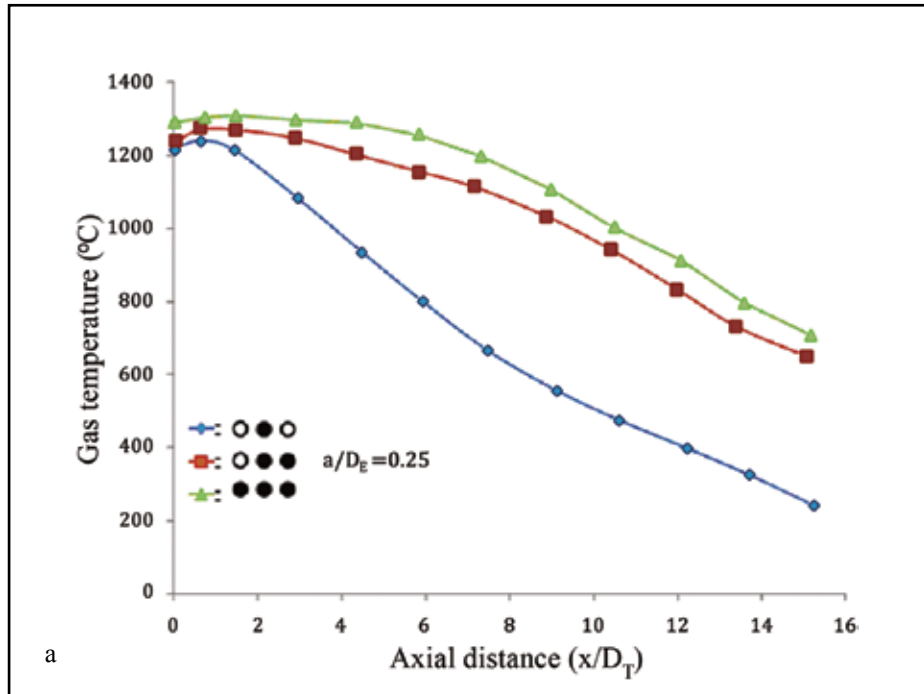

Figure 4-7a—Effect of nearby burners on flame temperature (from Chigier and Apak 1975).  $D_T$  is throat diameter,  $D_E$  is exit diameter,  $a$  is separation distance,  $T_m$  is merged flame temperature, and  $T_s$  is single flame temperature.

Delichatsios (2007) (all fully merged flames). Also, vorticity can greatly increase flame height as well (Emmons 1965).

This literature suggests that in a mass fire situation, as the flames grow closer together, the heat release rate and characteristic “burner” diameter should increase. The net effect is most likely an increase in the flame height. If more spot fires were ignited in the burning area, for example, the flame height would increase further. This is consistent with the observations of spot ignitions on prescribed burns (Johansen 1984) and mass spotting in wildfires (Cheney and Bary 1969). However, for a sufficiently large area or mass fire, when the nondimensional group  $N \sim Q^2/D^5$  is near  $10^{-6}$ , the fire is not expected to burn as a continuous flame but will break up into many distributed flamelets (Countryman 1969, Heskestad 1991, Wood et al. 1971). In this case, the flame height will be less than that predicted for a fully merged, continuous flame but larger than that of isolated flames (Thomas 1963).

## Flame Temperatures and Pollutants

As discussed in relation to flame height, as fires are moved closer together, air entrainment is blocked and the gaseous fuel must travel higher to find sufficient air for combustion. Experiments by Chigier and Apak (1975) indicated that a fuel particle on its journey from the base to the tip of an interacting turbulent flame would experience delayed combustion compared to an independent flame (see fig. 4-7a). The delay means that the maximum temperature of the interacting flames would occur further from the flame base. With limited mixing of fresh air into the flame to provide cooling, the temperatures inside an interacting flame decay more slowly with height so the flame is hot over a greater portion. In addition, limited mixing of air into the flames causes the formation of more carbon monoxide inside the flame zone. This prompted Countryman (1969) to speculate that the lack of oxygen in conjunction with elevated carbon monoxide could be fatal to ground personnel trapped inside the burning area.

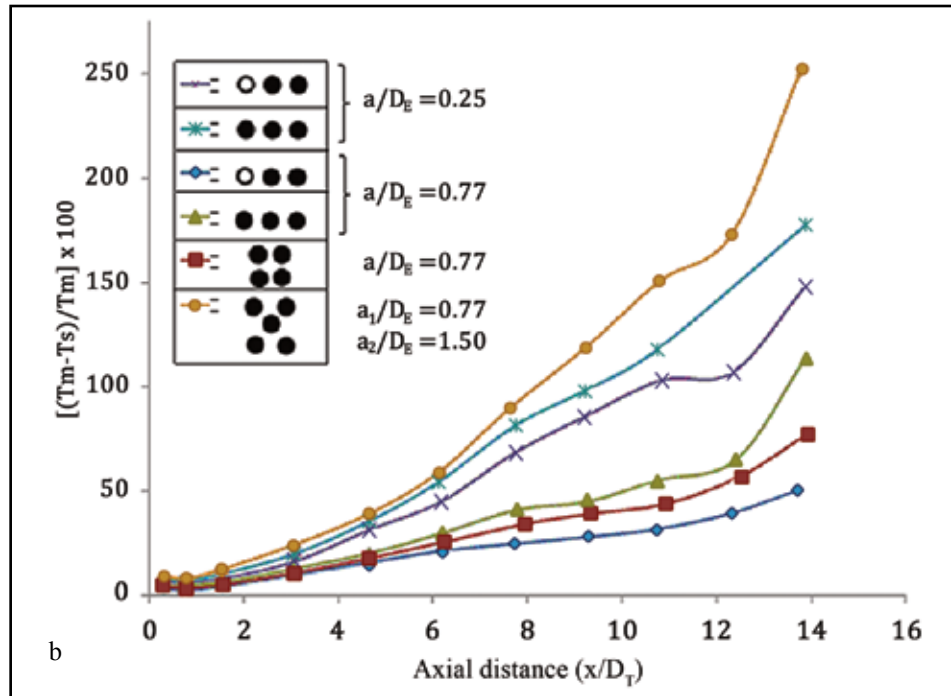

Figure 4-7b—Temperature compared to independent flame for varying axial distance along flame, number of burners, burner arrangement, and burner spacing (from Chigier and Apak 1975).

Chigier and Apak (1975) also showed that the maximum temperature achieved by interacting turbulent flames is also a function of the separation distance and the number of burners (see fig. 4-7b). When the flames are close enough to interact, they lose less heat from radiation (the surroundings are at the same temperature) and by mixing with cool, fresh air. The maximum temperatures inside interacting flames therefore increase as the number of fires increases and as the burners get closer together. These increased temperatures could produce more of the smog-forming nitrogen oxide emissions (Tarr and Allen 1998).

### Indraft Velocity

In typical fire situations where the flame height is relatively tall compared to the fire diameter, standard correlations exist to predict the mass of air entrained by the fire and its plume owing to the velocity difference between the plume gases and the ambient air. This air entrainment causes an inflow into the fire and is generally responsible for the bending of two flames in relative proximity. However,

the standard correlations of plume theory are valid only above the flame. Although several plume theories exist in the literature (see review in Heskestad 2008), there is general agreement that the total mass of air entrained can be estimated as proportional to the convective heat release rate (heat release rate minus radiative and other losses) raised to the one-third power and to the height above the fire source to the five-thirds power. Fires with greater heat release rate entrain more air, and the total amount of air entrained increases with height above the plume. Note, however, that the velocity of the flow inside the plume decreases with height, so at some point near the top of the plume no further air is entrained (no velocity difference). Current research on the indraft caused by entrainment as related to fire interactions is focused mainly on providing better quantitative predictions with computational fluid dynamics (CFD) modeling (Morvan et al. 2009, Roxburgh and Rein 2008).

However, plumes from wildfires can interact with local meteorology (Weber and Dold 2006) such as wind and atmospheric conditions. Additionally, classic plume theory

for entrainment rates may not hold for small ratios of the flame height to fire diameter ( $L_f/D$ ). Although the exact threshold is not known, Heskestad (2008) contends that the standard plume theory falls apart for  $L_f/D$  somewhere between 0.14 to 0.9. The perimeter of the plume where entrainment occurs becomes too small in relation to the volume of air inside and the slow moving entrained air will not have much effect on the momentum of the entire plume. Mass fires by definition fall into the range of flame height to fire diameter ratios where classic plume theory does not hold. The results of the Project Flambeau burns confirm that there is little entrainment into the plume core (Palmer 1981). Many authors (e.g., Adams et al. 1973, Small et al. 1983, Smith et al. 1975) also argue that the entrainment of plume theory does not account for the reported high-velocity winds associated with mass fires. As discussed earlier, mass fires are characterized by such strong indrafts that the fire does little outward propagation. In their review of the range of possible indraft velocities, Trelles and Pagni (1997) showed that indraft velocities of large fires can range from about 2 to 40 m/s. In the Project Flambeau burns, Countryman (1964, 1965, 1969) also reported complicated airflow patterns and strong downdrafts that cannot be accounted for with simple plume theory.

There seem to be two main theories in the literature as to what causes the high-velocity inflows. One theory, advanced by Baum and McCaffrey (1989) and Carrier et al. (1985) is that large-scale vorticity in conjunction with heat release is responsible. These models contend that the entire fire plume slowly rotates. Note, however, that Church et al. (1980) and McRae and Flannigan (1990) characterized this type of motion as one type of fire whirl. In Baum and McCaffrey's model (also used by Trelles and Pagni 1997 and Ohlemiller and Corley 1994), this rotation is caused by density gradients from the high heat release, and not necessarily by any imposed swirling caused by the ambient environment. The slow rotation of such a large mass of air above the ground translates to high-velocity, purely horizontal, and nonrotating flow at the ground. One unique feature of the Baum and McCaffrey model is that it treats the large

area fire as an ensemble of randomly distributed individual fires of varying strengths. Because of the method chosen to represent the fire, the model is only valid for heights above the fuel bed where the plumes of the individual fires have not merged. The model of Carrier et al. (1985) was intended to determine how long it would take to spin up the convective column and under what conditions this occurred. Based on the fact that the fire in Hamburg, Germany, took 2 hours to develop, they concluded that the growth of swirl, at least in this case, was most likely due to the intensification of a preexisting vortex from earlier fires and bombings. Although this contradicts the Baum and McCaffrey model, the experiments and discussion by Church et al. (1980) support this argument. The spatial orientation of individual fires may cause a swirling flow owing to the interaction of the indrafts to each fire (Soma and Saito 1991). Carrier et al. (1985) found that large-diameter plumes spin up faster, and proposed a set of four criteria that must be met for a "firestorm" to develop: heat release of  $10^6$  MW over a localized area for 2 to 3 hours, a preexisting weak vortex, low ambient winds, and a nearly dry-adiabatic lapse rate over the first few kilometers of the atmosphere.

Because it seems unlikely that all the criteria for spin-up of a convective column will be met, another theory, advanced by Smith et al. (1975) and Small et al. (1983) is proposed. These authors claimed that buoyancy-induced pressure gradients are responsible for the large indrafts. Smith et al. (1975) used a simple two-dimensional model of a convective column over a hot area to effectively show that near the fire, a dynamic pressure gradient can cause high-velocity inflow. This dynamic pressure gradient is caused by a balance between hydrostatic pressure and buoyancy. Buoyancy pushes the hot gases up while atmospheric pressure pushes fresh air at the ground in toward the fire horizontally to fill the gap left by the rising gases. Smith et al. (1975) also suggested that the traditional "weakly buoyant" plume theories described above may be valid for a small range of plume heights sufficiently far away from the fire and any inversion layer above. Small et al. (1983) used a similar model to that of Smith et al. (1975) but included



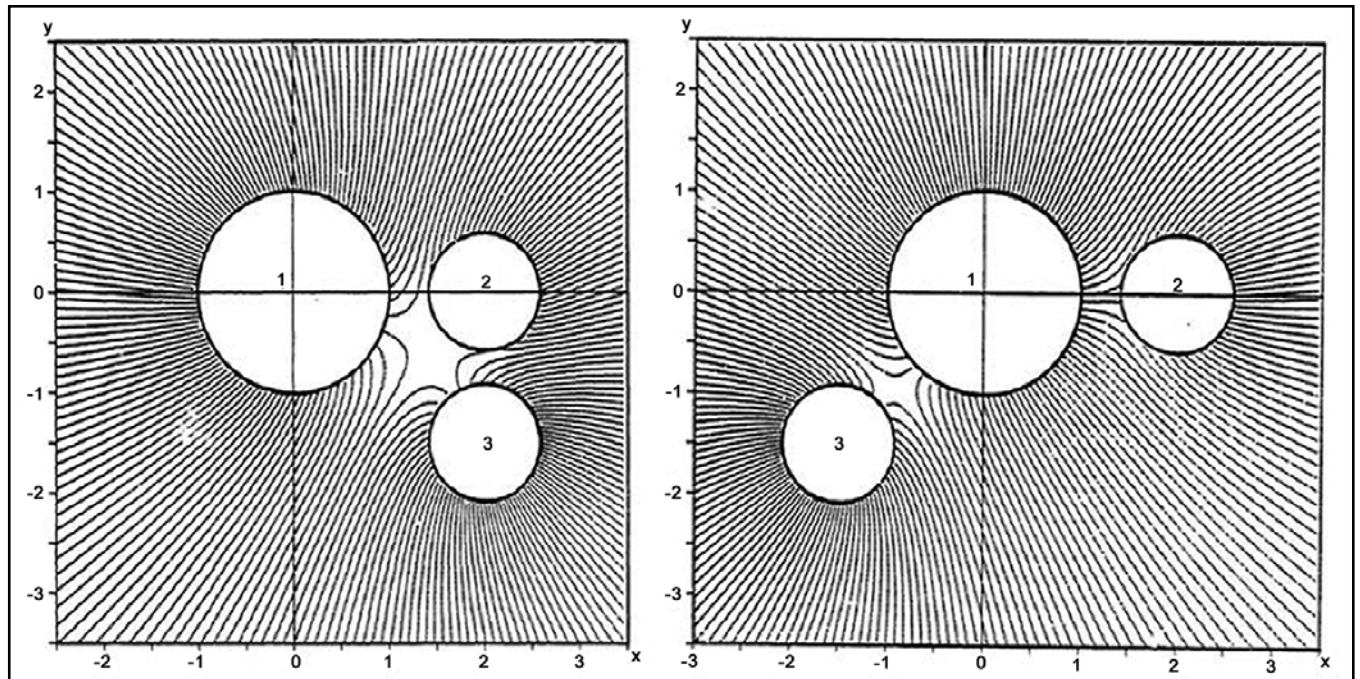

Figure 4-8—Model results for flow-field streamlines for three fires in proximity (from Weihs and Small 1986).

a volume heat addition and large density and temperature gradients. Small et al. (1983) also numerically matched their model results of the area near the fire to the results of traditional plume theory for the region far from the fire. In both the Smith et al. (1975) and Small et al. (1983) models, the fire is treated as a single large heat source (fig. 4-8). Small et al. (1983) used their model to demonstrate how the maximum indraft velocity varies with fire radius, burning rate, and fire height (fig. 4-8). They showed that the maximum indraft velocity at first increases but eventually levels off (to approximately 40 m/s) with increases in both the fire radius and the burning rate. On the other hand, the maximum indraft velocity appears to be linear with fire height.

A third, not yet well-explored explanation was proposed by Carrier et al. (1984). In this work, they used classic plume theory, but assumed that the fire does not burn as a single fire, but a collection of individual fires. They hypothesized that the high indraft velocities are then due to the increased fire perimeter from this “multicellular burning zone.” This hypothesis was not further developed, and in later works, these authors treated the fire as a subterranean

point source. Interestingly, both the Baum and McCaffrey (1989) and Small et al. (1983) models reasonably replicate what little experimental data are available. However, the theories differ slightly in their predictions of the distance away from the fire that these indrafts extend (Pitts 1991). The model of Baum and McCaffrey (1989) predicts that the high-velocity indrafts will extend much farther from the fire compared to the model of Small et al. (1983). Without more detailed experimental data, it is impossible to say which model more accurately portrays the physics.

### Pulsation

Although not an effect of flame interactions, flame pulsation (or puffing) is an interesting phenomenon that can occur in stationary fires, such as a mass fire. This pulsation typically occurs in circular or axisymmetric fires in weak ambient wind and is periodic in nature. Flame pulsation is important to many researchers because it can have a large influence on air entrainment rates and therefore heat release rates and pollution formation (Ghoniem et al. 1996). Observations of this phenomenon reveal the expansion of the flame near the



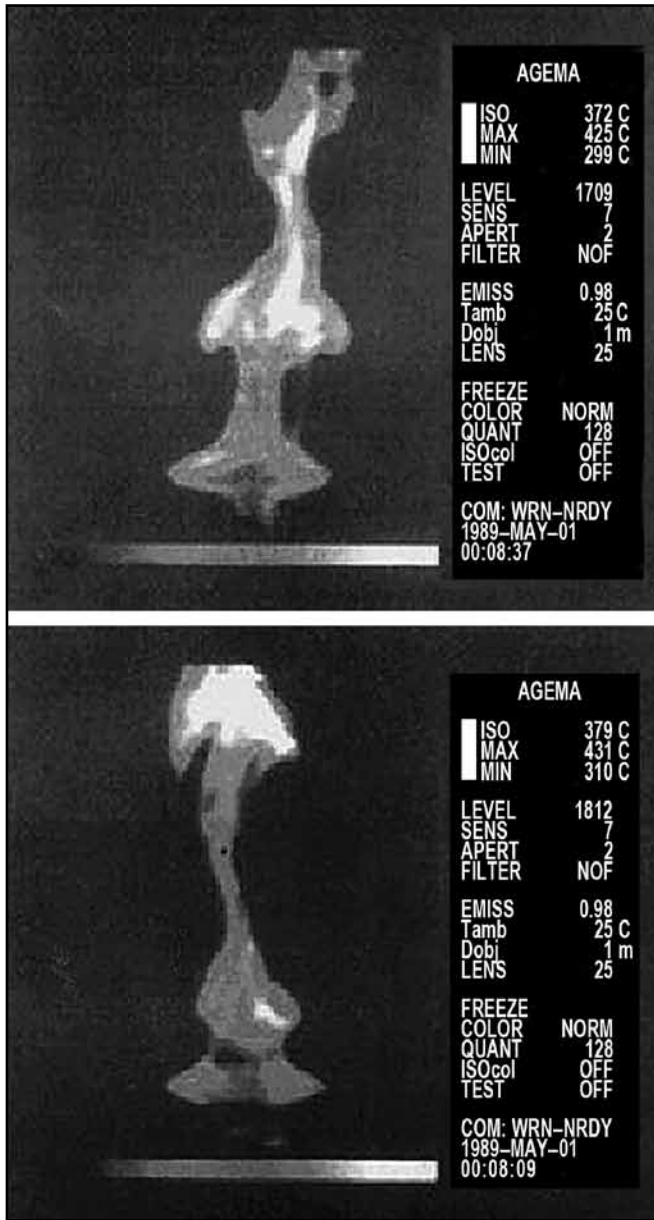

Figure 4-9—Thermal images of flame pulsation (from Malalasekera et al. 1996).

base of the fire as a toroidal vortex, about the size of the fire diameter. As this vortex is shed and propagates upward, the flame necks inward giving the appearance of a “mushroom” shape. Figure 4-9 illustrates the process with time sequence of photos. Not all circular flames pulsate, however. Using dimensional analysis, Byram and Nelson (1970) attempted to describe what type of fires will pulsate. They defined a

dimensionless “buoyancy” number,  $\pi_2 = Q_c / [(gD)^{0.5} \rho c_p T]$ , where  $Q_c$  is the rate of convective heat release per area,  $g$  is the acceleration due to gravity,  $D$  is the fire diameter, and  $\rho$ ,  $c_p$ , and  $T$  are the density, specific heat, and temperature of the ambient air. Although no quantitative values were given, they argued that a fire will not pulsate if  $\pi_2$  is either too small (low heat release rate relative to large fire diameter) or too large (large heat release rate relative to small fire diameter).

Because this puffing occurs in nonreacting helium plumes, it is actually not caused by a combustion instability, but instead is produced by a fluid dynamic instability (Cetegen and Ahmed 1993). There is disagreement about the actual cause of the instability (Tieszen 2001), but the vortex is generally thought to be formed because of the interaction between gravity and the density gradient between the flame and ambient air temperatures (Ghoniem et al. 1996).

Most of what has been learned about the characteristics of pulsation has been learned through experiments. Cetegen and Ahmed (1993) showed that the toroidal vortex forms within one fire diameter above the flame base and that the frequency of the puffing is insensitive to the fuel or the heat release rate. By plotting the available data in the literature, Cetegen and Ahmed, and later Malalasekera et al. (1996), showed that the pulsation frequency is proportional to the fire diameter raised to the negative one-half power ( $f \sim D^{-1/2}$ ) so that large fires pulsate at a much lower frequency than small fires. Though this correlation was developed using data from fires ranging from 0.1 to 100 m in diameter (four orders of magnitude) using gaseous, liquid, and solid fuels, Baum and McCaffrey (1989) suggested that it may well hold for much larger fires as well. For a large fire with a diameter on the order of 20 km, Larson et al. (1982) estimated that the pulsation will occur every 20 min. Although it is not accounted for in the above correlation, Malalasekera et al. (1996) showed that increasing fuel flow rates also result in a small increase in puffing frequency, especially for small fire sizes. Because of this, Malalasekera et al. (1996) correlated the puffing frequency in a slightly different manner using the dimensionless Strouhal number (ratio of oscillation frequency to 1 over the characteristic time of convection)

and Froude number (ratio of inertia force to gravitational force), which retains the same dependency on fire diameter but allows for a correction owing to changes in fuel flow velocity.

### **Convection Column**

Mass fires are also described as having very tall convection columns, or smoke plumes with large cloud structures because of the moisture release from combustion (Small and Heikes 1988). As discussed in the section on indraft velocities, the entrainment of cold, ambient air slows the rise of the hot gases by cooling them. Additionally, the density of the ambient air itself decreases with elevation. As the hot gases rise and cool, the density difference driving their upward motion disappears. It follows then that the top of the smoke plume corresponds to the height where the combustion products stop rising. As the fire diameter grows, however, the entrainment predicted by classic plume theory becomes less effective. Entrainment occurs at the perimeter of the plume, and with large fire sources there is such a large core of hot gases that entrainment is less effective at slowing the rise of the combustion products (Palmer 1981). Thus, it takes longer to entrain enough cold air to slow the combustion products, and therefore the smoke plume becomes taller. For example, a lack of entrainment to the convection column was noted and discussed by Taylor et al. (1973) on a large prescribed burn. In fact, the plume from a sufficiently large mass fire may be almost as wide as it is tall, so Brode and Small (1986) and Palmer (1981) contended that air entrainment is not likely to be a major influence on plume height and that it is the structure of the atmosphere itself that is the limiting factor. The plume of large mass fires is therefore more sensitive to atmospheric gradients, inversion heights, and upper atmosphere crosswinds (see also Penner et al. 1986). Brode and Small (1986) showed that the tropopause/stratosphere transition may be what actually caps the smoke plume. Note, these theories contradict the suggestion of Smith et al. (1975) that the traditional plume theory holds at some intermediate height above the ground. Perhaps the scale of the fires modeled by Smith et al. (1975) was not large enough to see this effect.

Palmer (1981) described the interesting structure of the convection columns that formed during the Project Flambeau tests. In the first few minutes of these large-scale burns, the majority of the gaseous combustion products were contained in a “bubble” near the fire. Once the “bubble” got sufficiently hot, the associated buoyancy was enough to overcome the surface drag forces and the bubble rose. As the bubble rose, a vortex ring would form in a similar manner described above with respect to flame pulsations. Regardless of the atmospheric stability, this vortex ring would rise until it encountered a region of vertical wind shear. The vertical wind shear weakened the vortex enough for the plume to then follow the prevailing horizontal winds. Palmer (1981) also noted that the “exterior form of the convection column at a particular altitude was determined by the initial vortex bubble as it passed that altitude.” Most of the plumes in these fires began to rotate as a single vertical vortex, as suggested by the Baum and McCaffrey (1989) model. This rotation further inhibits entrainment, which would also prevent the use of classic plume models for mass fires (Banta et al. 1992).

### **Summary of Interaction Effects**

As the individual spot fires grow together, they will begin to interact. This interaction will increase the burning rates, heat release rates, and flame height until the distance between them reaches a critical level. At the critical separation distance, the flames will begin to merge together and burn with the maximum rate and flame height. As these spot fires continue to grow together, the burning and heat release rates will finally start to decrease but remain at a much elevated level compared to the independent spot fire. The flame height is not expected to change significantly. The more spot fires, the bigger the increase in burning rate and flame height.

### **Needs for Further Research and Application**

The characteristics of many fire interactions have been examined and reported in the research literature, leaving

little doubt that local spread and behavior experienced by wildland fire personnel can be greatly influenced by fire configurations at larger scales. The ignition patterns and “suppression fire” tactics used in firefighting (Castellnou et al. 2010, Miralles et al. 2010) depend on understanding these interactions. However, questions remain about how to extend the findings of fundamental research to the field scale for wildland fires and mass fires. In particular, there is no clear method to determine the minimum separation distance between two fires for interaction and merging to occur. The influence of ambient winds or topography on interactions is directly relevant to wildfire management activities and tactics but has not been explored. Large-area fires were discussed as an extreme case of fire interactions and often behave quite differently than propagating line fires. Just how much area must be ignited to display “mass fire” characteristics is unknown. In the Project Flambeau experiments, Countryman (1964) argued that even these large fires were not large enough to be considered mass fires. Both Byram (1966) and Thomas et al. (1968) developed scaling laws in an attempt to answer this question, but many potentially limiting assumptions were made in the development and the laws were not validated. Baldwin and North (1967) attempted to quantify the minimum area for urban applications based on city layout and historical fires, but their estimations are admittedly crude. As discussed, there is no consensus in the literature about the convection column dynamics of mass fires and what mechanism is responsible for the reported strong indrafts. These suggestions are merely a starting point, as the subjects of fire interactions and mass fires clearly involve a great deal of physics and require the union of many fields of study.

## Literature Cited

- Adams, J.S.; Williams, D.W.; Tregellas-Williams, J. 1973.** Air velocity, temperature, and radiant-heat measurements within and around a large free-burning fire. Symposium (International) on Combustion. 14: 1045–1052.
- Albini, F.A. 1981.** A model for the wind-blown flame from a line fire. *Combustion and Flame*. 43: 155–174.
- Albini, F.A. 1982.** Response of free-burning fires to nonsteady wind. *Combustion Science and Technology*. 29: 225–241.
- Anderson, H.E. 1968.** The Sundance Fire. Res. Pap. INT-56. Ogden, UT: U.S. Department of Agriculture, Forest Service, Intermountain Forest and Range Experiment Station. 39 p.
- Arnold, R.K.; Buck, C.C. 1954.** Blow-up fires—silviculture or weather problems. *Journal of Forestry*. 1954(June): 408–411.
- Baldwin, R. 1966.** Some tentative calculations of flame merging in mass fires. Fire Research Note 629. Boreham Wood, Hertfordshire, England: Fire Research Station.
- Baldwin, R. 1968.** Flame merging in multiple fires. *Combustion and Flame*. 12(4): 318–324.
- Baldwin, R.; North, M.A. 1967.** The firestorm—its size and importance. Fire Research Note 645. Boreham Wood, Hertfordshire, England: Fire Research Station.
- Baldwin, R.; Thomas, P.H.; Wraight, H.G.G. 1964.** The merging of flames from separate fuel beds. Fire Research Note 551. Boreham Wood, Hertfordshire: Fire Research Station.
- Banta, R.M.; Olivier, L.D.; Holloway, E.T.; Kropfli, R.A.; Bartram, B.W.; Cupp, R.E.; Post, M.J. 1992.** Smoke-column observations from two forest fires using Doppler LIDAR and Doppler radar. *Journal of Applied Meteorology*. 31: 1328–1348.
- Baum, H.; McCaffrey, B. 1989.** Fire induced flow field—theory and experiment. *Fire Safety Science*. 2: 129–148.
- Beaufait, W.R. 1965.** Characteristics of backfires and headfires in a pine needle fuel bed. Res. Note INT-39. Ogden, UT: U.S. Department of Agriculture, Forest Service, Intermountain Forest and Range Experiment Station.

- Beer, T. 1995.** Fire propagation in vertical stick arrays: the effects of wind. *International Journal of Wildland Fire*. 5(1): 43–49.
- Beverly, J.L.; Wotton, B.M. 1997.** Modelling the probability of sustained flaming: predictive value of fire weather index components compared with observations of site weather and fuel moisture conditions. *International Journal of Wildland Fire*. 16: 161–173.
- Bradstock, R.A.; Gill, A.M. 1993.** Fire in semi-arid Mallee shrublands: size of flames from discrete fuel arrays and their role in the spread of fire. *International Journal of Wildland Fire*. 3(1): 3–12.
- Brode, H.L.; Small, R.D. 1986.** A review of the physics of large urban fires. In: *The medical implications of war*. Washington, DC: Institute of Medicine, National Academies Press. 620 p.
- Brown, J.K. 1982.** Fuel and fire behavior prediction in big sagebrush. Res. Pap. INT-290. Ogden, UT: U.S. Department of Agriculture, Forest Service, Intermountain Forest and Range Experiment Station. 12 p.
- Bruner, A.D.; Klebenow, D.A. 1979.** Predicting success of prescribed fires in pinyon-juniper woodland in Nevada. Res. Pap. INT-219. Ogden, UT: U.S. Department of Agriculture, Forest Service, Intermountain Forest and Range Experiment Station. 12 p.
- Burrows, N.; Ward, B.; Robinson, A. 1991.** Fire behavior in spinefex fuels on the Gibson Desert Nature Reserve, Western Australia. *Journal of Arid Environments*. 20: 189–204.
- Byram, G.M. 1966.** Scaling laws for modeling mass fires. *Pyrodynamics*. 4: 271–284.
- Byram, G.M.; Nelson, R.M. 1970.** The modeling of pulsating fires. *Fire Technology*. 6(2): 102–110.
- Carrier, G.; Fendell, F.; Feldman, P. 1984.** Big fires. *Combustion Science and Technology*. 39: 135–162.
- Carrier, G.F.; Fendell, F.E.; Feldman, P.S. 1985.** Firestorms. *Journal of Heat Transfer*. 107: 19–27.
- Castellnou, M.; Kraus, D.; Miralles, M.; Delogu, G. 2010.** Suppression fire use in learning organizations. In: Silva, J.S.; Rego, F.; Fernandes, P.; Rigolot, E., eds. *Towards integrated fire management—outcomes of the European Project Fire Paradox*. Res. Rep. 23. Joensuu, Finland: European Forest Institute: 189–201. Chapter 5.2.
- Catchpole, E.A.; DeMestre, N.J.; Gill, A.M. 1982.** Intensity of fire at its perimeter. *Australian Forest Research*. 12: 47–54.
- Cetegen, B.M.; Ahmed, T.A. 1993.** Experiments on the periodic instability of buoyant plumes and pool fires. *Combustion and Flame*. 93: 157–184.
- Chandler, C.C. 1963.** A study of mass fires and conflagrations. Res. Note PSW-N22. Berkeley, CA: U.S. Department of Agriculture, Forest Service, Pacific Southwest Forest and Range Experiment Station. 9 p.
- Chandler, C.C.; Storey, T.G.; Tangren, C.D. 1963.** Prediction of fire spread following nuclear explosions. Res. Pap. PSW-5. Berkeley, CA: U.S. Department of Agriculture, Forest Service, Pacific Southwest Forest and Range Experiment Station. 110 p.
- Cheney, N.P. 1981.** Fire behavior. In: Gill, A.M.; Groves, R.H.; Noble, I.R., eds. *Fire and the Australian biota*. Canberra, ACT: Australian Academy of Science: 151–175. Chapter 7.
- Cheney, N.P.; Bary, G.A.V. 1969.** The propagation of mass conflagrations in a standing eucalypt forest by the spotting process. In: *Proceedings, Mass fire symposium*. Canberra, Australia: Defense Standards Laboratory: 1 (Sessions A and B): 1–11.
- Cheney N.P.; Gould J.S. 1995.** Fire growth in grassland fuels. *International Journal of Wildland Fire*. 5: 237–247.
- Chigier, N.A.; Apak, G. 1975.** Interaction of multiple turbulent diffusion flames. *Combustion Science and Technology*. 10 (5-6): 219–231.

- Church, C.R.; Snow, J.T.; Dessens, J. 1980.** Intense atmospheric vortices associated with a 1000 MW fire. *Bulletin of the American Meteorological Society*. 61(7): 682–694.
- Countryman, C.M. 1964.** Mass fires and fire behavior. Res. Pap. PSW-19. Berkeley, CA: U.S. Department of Agriculture, Forest Service, Pacific Southwest Forest and Range Experiment Station. 53 p.
- Countryman, C.M. 1965.** Mass fire characteristics in large scale tests. *Fire Technology*. 2: 303–317.
- Countryman, C.M. 1969.** Project Flambeau... an investigation of mass fire (1964–1967) final report. Prepared for Office of Civil Defense under OCD Work Order No. OCD-PS-65-26. Berkeley, CA: U.S. Department of Agriculture, Forest Service, Pacific Southwest Forest and Range Experiment Station. Volume 1.
- Curry, J.R.; Fons, W.L. 1938.** Rate of spread of surface fires in the ponderosa pine type of California. *Journal of Agriculture Research*. 57(2): 39–267.
- Delichatsios, M. 2007.** A correlation for the flame height in “group” fires. *Fire Science and Technology*. 26(1): 1–8.
- Dold, J.W.; Zinoviev, A. 2009.** Fire eruption through intensity and spread rate interaction mediated by flow attachment. *Combustion Theory and Modeling*. 13(5): 763–793.
- Dold, J.W.; Zinoviev, A.; Weber, R.O. 2006.** Nonlocal flow effects in bushfire spread rates. Paper presented at V International conference on forest fire research. Manchester, United Kingdom: University of Manchester. 9 p.
- Eggleston, L.A. 1968.** Electronic simulation of mass fires. Spring meeting of the Central States Section of the Combustion Institute. Los Angeles, CA: University of Southern California: 1–11.
- Emmons, H.W. 1965.** Fundamental problems of the free burning fire. *Symposium (International) on Combustion*. 10: 951–964.
- Emori, R.I.; Saito, K. 1983.** A study of scaling laws in pool and crib fires. *Combustion Science and Technology*. 31: 217–231.
- Fendell, F.E.; Wolff, M.F. 2001.** Wind-aided fire spread. In: Johnson, E.A.; Miyanishi, K., eds. *Forest fires: behavior and ecological effects*. Maryland Heights, MO: Academic Press: 171–223.
- Finney, M.A.; Cohen, J.D.; Yedinak, K.M.; Grenfell, I.C. 2010.** An examination of fire spread thresholds in discontinuous fuelbeds. *International Journal of Wildland Fire*. 19(2): 163–170.
- Fosberg, M.A. 1967.** Evaluation of the natural length scale in mass fires. *Proceedings: Tripartite technical cooperation program panel N-3 (thermal radiation) mass fire research symposium, DASA 1949. Special Report 59. Defense Atomic Support Agency Information and Analysis Center*.
- Fukuda, Y.; Kamikawa, D.; Hasemi, Y.; Kagiya, K. 2004.** Flame characteristics of group fires. *Fire Science and Technology*. 23(2): 164–169.
- Gebhart, B.; Shaukatullah, H.; Pera, L. 1976.** The interaction of unequal laminar plane plumes. *International Journal of Heat and Mass Transfer*. 19: 751–756.
- German, D. 1968.** Mass fire infrared measurements. Report D3-7655. Wichita, KS: Boeing Company.
- Ghoniem, A.F.; Lakkis, I.; Soteriou, M. 1996.** Numerical simulation of the dynamics of large fire plumes and the phenomenon of puffing. *Symposium (International) on Combustion*. 26: 1531–1539.
- Grishin, A.M.; Golovonov, A.N.; Sukov, Y.V. 2004.** Physical modeling of firestorms. *Doklady Physics*. 49(3): 191–193.



- Grumer, J.; Strasser, A. 1965.** Uncontrolled fires—specific burning rates and induced air velocities. *Fire Technology*. 1(4): 256–268.
- Heskestad, G. 1991.** A reduced-scale mass fire experiment. *Combustion and Flame*. 83: 293–301.
- Heskestad, G. 1998.** Dynamics of the fire plume. *Philosophical Transactions of the Royal Society of London*: A356: 2815–2833.
- Heskestad, G. 2008.** Fire plumes, flame height, and air entrainment. *SFPE handbook of fire protection engineering*. 4<sup>th</sup> ed. Quincy, MA: National Fire Protection Association.
- Hewitt, K. 1983.** Place annihilation: area bombing and the fate of urban places. *Annals of the Association of American Geographers*. 73(2): 257–284.
- Huffman, K.G.; Welker, J.R.; Sliepcevich, C.M. 1969.** Interaction effects of multiple pool fires. *Fire Technology*. 5(3): 225–232.
- Johansen, R.W. 1984.** Prescribed burning with spot fires in the Georgia coastal plain. *Forest Res. Pap.* 49. Macon, GA: Georgia Forestry Commission. 6 p.
- Johansen, R.W. 1987.** Ignition patterns and prescribed fire behavior in southern pine forests. *Forest Res. Pap.* 72. Macon, GA: Georgia Forestry Commission.
- Kamikawa, D.; Wend, W.G.; Kagiya, K.; Fukuda, Y.; Mase, R.; Hasemi, Y. 2005.** Experimental study of merged flames from multifire sources in propane and wood crib burners. *Combustion and Flame*. 142: 17–23.
- Kucuk, O.; Bilgili, E.; Baysal, I. 2007.** Fire development from a point source in surface fuels of a mature Anatolian black pine stand. *Turkish Journal of Agriculture and Forestry*. 31: 263–273.
- Larson, D.A.; Brode, H.L.; Small, R.D. 1982.** Time-dependent model of flows generated by large area fires. Note 483. Los Angeles, CA: Pacific-Sierra Research Corp.
- Larson, D.A.; Small, R.D. 1982a.** Analysis of the large urban fire environment: Part I. Theory. PSR Report 1210. Final report contract EMW-C-0747. Arlington, VA: Pacific-Sierra Research Corp.
- Larson, D.A.; Small, R.D. 1982b.** Analysis of the large urban fire environment: Part II. Parametric analysis and model city simulations. PSR Report 1210. Final report contract EMW-C-0747. Arlington, VA: Pacific-Sierra Research Corp.
- Lee, B.T. 1969a.** Mass fire scaling with small electrically heated models. Spring meeting of the Central States Section of the Combustion Institute. Minneapolis, MN: University of Minnesota: 1–2.
- Lee, B.T. 1969b.** Mass fire scaling with small electrically heated models. NRDL-TR-69. Final report, Office of Civil Defense contract No. DAHC20-67-C-0149. San Francisco, CA: Naval Radiological Defense Laboratory.
- Leonard, S. 2009.** Predicting sustained fire spread in Tasmanian native grasslands. *Environmental Management*. 44: 430–440.
- Liu, N.; Liu Q.; Deng, Z.; Satoh, K.; Zhu, J. 2007.** Burn-out time data analysis on interaction effects among multiple fires in fire arrays. *Proceedings of the Combustion Institute*. 31: 2589–2597.
- Liu, N.; Liu, Q.; Lozano, J.S.; Shu, L.; Zhang, L.; Zhu, J.; Deng, Z.; Satoh, K. 2009.** Global burning rate of square fire arrays: experimental correlation and interpretation. *Proceedings of the Combustion Institute*. 32: 2519–2526.
- Lommasson, T.E.; Keller, J.A.; Kirkpatrick, R.G. 1967.** Firestorm analysis. DC-TN-2046-1. Division of Fire Research U.S. Forest Service contract No. 13-248. Los Angeles, CA: Dikewood Corporation.
- Lommasson, T.E.; Miller, R.K.; Kirkpatrick, R.G.; Keller, J.A. 1968.** A firestorm existence and buildup hypothesis. DC-FR-1058.0. Defense Atomic Support Agency contract No. DASA 01-67-C-0008. Los Angeles, CA: Dikewood Corporation.

- Luke, R.H.; McArthur, A.G. 1978.** Bushfires in Australia. Canberra, ACT, Australia: Australian Government Publishing Service. 359 p.
- Malalasekera, W.M.G.; Versteed, H.K.; Gilchrist, K. 1996.** A review of research and an experimental study on the pulsation of buoyant diffusion flames and pool fires. *Fire and Materials*. 20: 261–271.
- Marsden-Smedley, J.B. 2009.** Planned burning in Tasmania: operational guidelines and review of current knowledge. Hobart, Tasmania: Fire Management Section, Parks and Wildlife Service, Department of Primary Industries, Parks, Water and the Environment.
- Marsden-Smedley, J.B.; Catchpole, W.R.; Pryke, A. 2001.** Fire modeling in Tasmanian buttongrass moorlands. IV. Sustaining versus non-sustaining fire. *International Journal of Wildland Fire*. 10: 255–262.
- Martin, R.E.; Dell, J.D. 1978.** Planning for prescribed burning in the inland Northwest. Gen. Tech. Rep. GTR-76. Portland, OR: U.S. Department of Agriculture, Forest Service, Pacific Northwest Forest and Range Experiment Station. 74 p.
- Martin, R.E.; Finney, M.A.; Molina, D.M.; Sapsis, D.B.; Stephens, S.L.; Scott, J.H.; Weise, D.R. 1991.** Dimensional analysis of flame angles versus wind speed. In: Andrews, P.L.; Potts, D., eds. 11<sup>th</sup> Conference on fire and forest meteorology. Bethesda, MD: Society of American Foresters: 212–218.
- McAlpine, R.S.; Wakimoto, R.H. 1991.** The acceleration of fire from point source to equilibrium spread. *Forestry Science*. 37(5): 1314–1337.
- McArthur, A.G. 1969a.** The behavior of mass fires in felled eucalypt forest originating from a simultaneous grid or line ignition system. Paper A1. In: Mass fire symposium. Canberra, Australia: Defense Standards Laboratory: 1–34.
- McArthur, A.G. 1969b.** The Tasmanian bushfires of 7<sup>th</sup> February, 1967, and associated fire behavior characteristics. Paper A7. In: Mass fire symposium. Canberra, Australia: Defense Standards Laboratory: 1–23.
- McCaffrey, B. 1995.** Flame heights. SFPE handbook of fire protection engineering, 2<sup>nd</sup> ed. Quincy, MA: National Fire Protection Association.
- McRae, D.J. 1999.** Point-source fire growth in jack pine slash. *International Journal of Wildland Fire*. 9(1): 65–77.
- McRae, D.J.; Flannigan, M.D. 1990.** Development of large vortices on prescribed fires. *Canadian Journal of Forest Research*. 20: 1878–1887.
- McRae, D.J.; Jin, J.-Z.; Conard, S.G.; Sukhinin, A.I.; Ivanova, G.A.; Blake, T.W. 2005.** Infrared characterization of fine-scale variability in behavior of boreal forest fires. *Canadian Journal of Forest Research*. 35: 2194–2206.
- Miralles, M.; Kraus, D.; Molina, F.; Loureiro, C.; Delogu, G.; Ribet, N.; Vilalta, O. 2010.** Improving suppression fire capacity. In: Silva, J.S.; Rego, F.; Fernandes, P.; Rigolot, E., eds. Towards integrated fire management—outcomes of the European Project Fire Paradox. Res. Rep. 23. Joensuu, Finland: European Forest Institute: 203–215. Chapter 5.3.
- Morvan, D.; Hoffman, C.; Rego, F.; Mell, W. 2009.** Numerical simulation of the interaction between two fire fronts in the context of suppression fire operations. In: 8<sup>th</sup> Symposium on fire and forest metrology. Boston, MA: American Meteorological Society: 1–11.
- Nelson, R.M.; Adkins, C.W. 1986.** Flame characteristics of wind-driven surface fires. *Canadian Journal of Forest Research*. 16: 1293–1300.
- Nielson, H.J. 1970.** Mass fire data analysis. Final report for Defense Atomic Support Agency Report No. 2018. Project J6099. Chicago, IL: Illinois Institute of Technology Research Institute.

- Nielson, H.J.; Tao, K.; Wolf, L. 1963.** Analysis of convection column above a fire storm. Final report, Office of Civil Defense contract No. OCD-OS-62-82. Chicago, IL: Illinois Institute of Technology Research Institute.
- Nmira, F.; Consalvi, J.L.; Boulet, P.; Porterie, B. 2010.** Numerical study of wind effects on the characteristics of flames from non-propagating vegetation fires. *Fire Safety Journal*. 45: 129–141.
- Ohlemiller, T.; Corley, D. 1994.** Heat release rate and induced wind field in a large scale fire. *Combustion Science and Technology*. 97: 315–330.
- Palmer, T.Y. 1981.** Large fire winds, gases and smoke. *Atmospheric Environment*. 15(10/11): 2079–2090.
- Parker, W.J. 1967.** Urban mass fire scaling considerations. USNRDL-TR-67-150. San Francisco, CA: U.S. Naval Radiological Defense Laboratory, OCD Work Unit No. 2536F.
- Penner, J.E.; Haselman, L.C.; Edwards, L.L. 1986.** Smoke-plume distributions above large-scale fires: implications for simulations of “nuclear winter.” *Journal of Climate and Applied Meteorology*. 25: 1434–1444.
- Pera, L.; Gebhart, B. 1975.** Laminar plume interactions. *Journal of Fluid Mechanics*. 68(2): 259–271.
- Pipkin, O.A.; Sliepcevich, C.M. 1964.** The effect of wind on buoyant diffusion flames. *Industrial and Engineering Chemistry Fundamentals*. 3(May): 147–154.
- Pitts, W.M. 1991.** Wind effects on fires. *Progress in Energy and Combustion Science*. 17: 83–134.
- Pryor, A.J.; Yuill, C.H. 1966.** Mass fire life hazard. Final report, contract No. N228(62479)68665. San Antonio, TX: Southwest Research Institute, Office of Civil Defense Work Unit 2537A.
- Putnam, A.A.; Speich, C.F. 1963.** A model study of the interaction of multiple turbulent diffusion flames. *Symposium (International) on Combustion*. 9: 876–877.
- Quintiere, J.G. 1993.** Canadian mass fire experiment. *Journal of Fire Protection Engineering*. 5(2): 67–78.
- Quintiere, J.G.; Grove, B.S. 1998.** A unified analysis for fire plumes. *Proceedings of the Combustion Institute*. 27: 2757–2766.
- Rios, J. 1966.** Interaction effects of wind-blown proximate flames from burning wood cribs. Norman, OK: University of Oklahoma. Ph.D. thesis.
- Rios, J.; Welker, J.R.; Sliepcevich, C.M. 1967.** Interaction of wind-blown flames from wood crib fires. *Fire Technology*. 3(2): 129–136.
- Rothermel, R.C. 1984.** Fire behavior considerations of aerial ignition. In: Mutch, R.W., tech. coord. *Prescribed fire by aerial ignition: proceedings of a workshop*. Intermountain Fire Council: 143–158.
- Roxburgh, R.; Rein, G. 2008.** Study of wildfire in-draft flows for counter fire operations. *Proceedings, forest fires: modelling, monitoring, and management of forest fires*. WIT Transactions on Ecology and the Environment. 119: 13–22.
- Sanderlin, J.C.; Ball, J.A.; Johanson, G.A. 1981.** Mass fire model concept. DNA 5803F. Final report for period 8 September 1980–31 May 1981. Contract No. DNA 001-80-C-0351. Santa Barbara, CA: Mission Research Corporation.
- Schmalz, R.F. 1992.** Conflagrations: disastrous urban fires. In: Majumdar, S.K.; Forbes, G.S.; Miller, E.W.; Schmalz, R.F., eds. *Natural and technological disasters: causes, effects and preventative measures*. The Pennsylvania Academy of Science: 62–74. Chapter 6.
- Small, R.D.; Heikes, K.E. 1988.** Early cloud formation by large area fires. *Journal of Applied Meteorology*. 27: 654–663.
- Small, R.D.; Larson, D.A.; Brode, H.L. 1981.** Analysis of large urban fires. PSR Report 1122. Final report contract EMW-C-0309. Arlington, VA: Pacific-Sierra Research Corporation.

- Small, R.D.; Larson, D.A.; Brode, H.L. 1983.** Fluid dynamics of large area fires. Proceedings of the 21<sup>st</sup> national heat transfer conference. New York: Society of Mechanical Engineers.
- Smith, R.K.; Morton, B.R.; Leslie, L.M. 1975.** The role of dynamic pressure in generating fire wind. *Journal of Fluid Mechanics*. 68(1): 1–19.
- Soma, S.; Saito, K. 1991.** Reconstruction of fire whirls using scale models. *Combustion and Flame*. 86: 269–284.
- Stocks, B.J. 1989.** Fire behavior in mature jack pine. *Canadian Journal of Forest Research*. 19: 783–790.
- Sugawa, O.; Takahashi, W. 1993.** Flame height behavior from multi-fire sources. *Fire and Materials*. 17: 111–117.
- Tarr, S.J.; Allen, G. 1998.** Flame interactions. Final technical report on performance prediction in advanced coal fired boilers. Contract No. JOF3–CT95–0005. Westminster, London, United Kingdom: International Combustion Limited, Rolls Royce Industrial Power Group.
- Taylor, R.J.; Evans, S.T.; King, N.K.; Stephens, E.T.; Packham, D.R.; Vines, R.G. 1973.** Convective activity above a large-scale bushfire. *Journal of Applied Meteorology*. 12: 1144–1150.
- Thomas, P.H. 1963.** The size of flames from natural fires. Symposium (International) on Combustion. 9: 844–859.
- Thomas, P.H. 1968.** On the development of urban fires from multiple ignitions. Fire Research Note 699. Boreham Wood, Hertfordshire, United Kingdom: Fire Research Station.
- Thomas, P.H.; Baldwin, R.; Theobald, C.R. 1968.** Some model scale experiments with multiple fires. Fire Research Note 700. Boreham Wood, Hertfordshire, United Kingdom: Fire Research Station.
- Tieszen, S.R. 2001.** On the fluid mechanics of fires. *Annual Review of Fluid Mechanics*. 33: 67–92.
- Tolhurst, K.G.; Cheney, N.P. 1999.** Synopsis of the knowledge used in prescribed burning in Victoria. Victoria, Australia: Department of Natural Resources and Environment, Fire Management.
- Trelles, J.; Pagni, P.J. 1997.** Fire induced winds in the 20 October Oakland Hills Fire. *Fire Safety Science*. 5: 911–922.
- Van Wagner, C.E. 1977.** Conditions for the start and spread of crown fire. *Canadian Journal of Forest Research*. 7: 23–34.
- Van Wagner, C.E. 1988.** Effect of slope on fires spreading downhill. *Canadian Journal of Forest Research*. 18: 818–820.
- Viegas, D.X.; Pita, L.P. 2004.** Fire spread in canyons. *International Journal of Wildland Fire*. 13: 253–274.
- Vogel, M.; Williams, F.A. 1970.** Flame propagation along matchstick arrays. *Combustion Science and Technology*. 1: 429–436.
- Wade, D.D.; Ward, D.E. 1973.** An analysis of the Airforce Bomb Range Fire. Res. Pap. SE-105. Asheville, NC: U.S. Department of Agriculture, Forest Service, Southeastern Forest Experiment Station. 38 p.
- Weatherspoon, C.P.; Almond, G.A.; Skinner, C.N. 1989.** Tree-centered spot firing—a technique for prescribed burning beneath standing trees. *Western Journal of Applied Forestry*. 4(1): 29–31.
- Weber, R.O. 1989.** Analytical models for fire spread due to radiation. *Combustion and Flame*. 78: 398–408.
- Weber, R.O. 1990.** A model for fire propagation in arrays. *Mathematical and Computer Modeling*. 3(12): 95–102.
- Weber, R.O.; Dold, J.W. 2006.** Linking landscape fires and local meteorology—a short review. *JSME International Journal*. Series B49(3): 590–593.
- Weihls, D.; Small, R.D. 1986.** Interactions and spreading of adjacent large area fires. DNA-TR-86-214. Arlington, VA: Pacific-Sierra Research Corporation. 38 p.

- Weise, D.R.; Bigging, G.S. 1996.** Effects of wind velocity and slope on flame properties. *Canadian Journal of Forest Research*. 26: 1849–1858.
- Weise, D.R.; Zhou, X.; Sun, L.; Mahalingam, S. 2005.** Fire spread in chaparral: “go or no-go.” *International Journal of Wildland Fire*. 14(1): 99–106.
- Welker, J.R.; Pipkin, O.A.; Sliepcevich, C.M. 1965.** The effect of wind on flames. *Fire Technology*. 1: 122–129.
- Welker, J.R.; Sliepcevich, C.M. 1966.** Bending of wind-blown flames from liquid pools. *Fire Technology*. 2(2): 127–135.
- Weng, W.G.; Kamikawa, D.; Fukuda, Y.; Hasemi, Y.; Kagiya, K. 2004.** Study on flame height of merged flame from multiple fire sources. *Combustion Science and Technology*. 176(12): 2105–2123.
- Williams, F.A. 1982.** Urban and wildland fire phenomenology. *Progress in Energy and Combustion Science*. 18: 317–354.
- Wood, B.D.; Blackshear, P.L.; Eckert, E.G.R. 1971.** Mass fire model: an experimental study of the heat transfer to liquid fuel burning from a sand-filled pan burner. *Combustion Science and Technology*. 4(1): 113–129.
- Woodburn, P.J.; Drysdale, D.D. 1998.** Fires in inclined trenches: the dependence of the critical angle on trench and burner geometry. *Fire Safety Journal*. 31:143–164.
- Wotton, B.M.; McAlpine, R.S.; Hobbs, M.W. 1999.** The effect of fire front width on surface fire behavior. *International Journal of Wildland Fire*. 9(4): 247–253.



This page was intentionally left blank.

## Chapter 5: Column/Plume Dynamics

Brian E. Potter<sup>1</sup>

### Introduction

“Plume dynamics” refers to the airflow related to a fire’s updraft and the way that updraft changes over time. In terms of extreme fire behavior, plume dynamics matter because they can bring the wind, moisture, and temperature conditions above the ground down to the ground where the fire is. These aboveground conditions may or may not be the same as the conditions at the ground, and the differences can produce unexpected changes in fire behavior. The updraft is part of a fire-driven circulation that includes downward air motion in other areas. The circulation also modifies the horizontal winds near the fire. The updraft also lifts burning embers that can subsequently lead to spot fires. Any of these can lead to a nonsteady state, or for the purposes of this review, extreme fire behavior. This section examines several concepts and tools related to plume dynamics that are well known in the fire management community, noting their foundations, strengths, weaknesses, and limitations. Spot fires are addressed in more detail in chapter 6.

Before considering specific concepts, it is important to understand how the plume, or updraft, relates to other air currents associated with a fire. These currents are of greater concern to the firefighter than the updraft, most of the time. Observations of wildland fires (Banta et al. 1992; Clements et al. 2006, 2007; Countryman 1969; Goens and Andrews 1998; Reid and Vines 1972; Schroeder and Buck 1970; Taylor et al. 1968, 1971, 1973) reveal many of these air currents. In addition, studies of the air currents in and around thunderstorms, in the absence of fire (Browning et al. 1976, Foote and Frank 1983, Houze et al. 1989, Klemp et al. 1981) provide additional information about the three-dimensional airflow associated with an updraft or plume. This model is a simplification and does not include the rapidly changing features of a real plume, but it is a useful foundation for discussing how plume dynamics con-

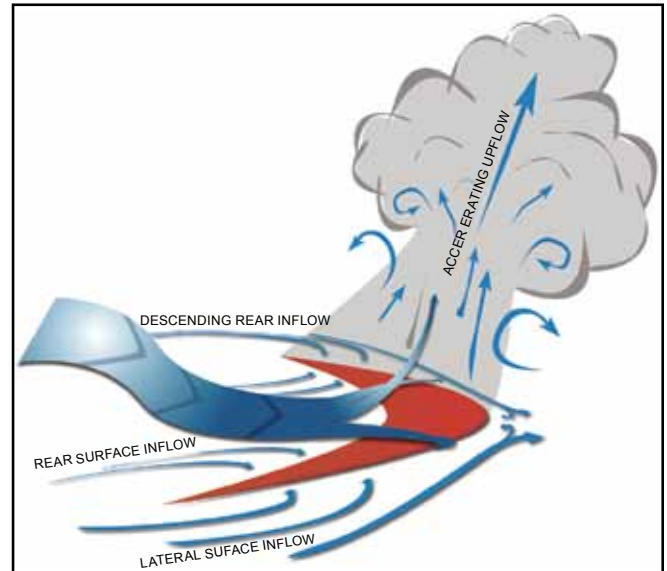

Figure 5-1—Conceptual model of the airflow in and around a fire’s plume.

tribute to extreme fire behavior. The rapidly changing features not included in this simple model include fire whirls (vortices), waves in the vertical and horizontal airflow, and turbulent eddies on a wide range of scales. Because they are not steady-state features, these are all closely related to what is commonly recognized as extreme fire behavior (fig. 5-1). The most consistently observed, best recognized characteristics of a fire plume are the updraft column, eddy vortices (whirls) along the perimeter at the fire’s head, and the winds blowing into the rear and sides of the fire at the ground. The updraft is the most obvious part of the plume as it is where the smoke is. It may consist of a sequence of puffs or turrets (each an updraft, itself) that separate from the fire front and move downwind. Near the ground, the updraft accelerates as it rises. The rate of acceleration depends on the stability and wind profiles of the atmosphere around the plume. The rear inflow, less often observed but often implicitly recognized, descends toward the back of the fire’s head. The acceleration of the updraft and the detailed path of the rear inflow are difficult to observe, so details

<sup>1</sup> **Brian E. Potter**, U.S. Department of Agriculture, Forest Service, Pacific Wildland Fire Sciences Laboratory, Seattle, WA.

of their character are very poorly known. The descending rear inflow, a sustained feature of moderate speed, is not the same as a downburst, which is a fast, short-lived and localized current.

## Plume-Dominated and Wind-Driven Fires

The most recognized connection between extreme fire behavior and plume dynamics is the concept of a plume-dominated or wind-driven fire. Generally, wind-driven fires are more predictable because the fire spreads with the wind. When someone labels a fire “plume dominated” it is because the smoke plume is standing near vertically and there is little visible influence of horizontal wind on it. In common usage, the implication is that the fire’s behavior may change rapidly and that the fire’s direction of spread could change unexpectedly. The distinction between these two broad categories comes from Byram (1959), who introduced the power of the fire and power of the wind ( $P_f$  and  $P_w$ ) and identified them as the energy-criterion equations. The equations and energies are intended to help identify when a fire is dominated by what Byram called “its own energy” as opposed to being dominated by the energy of the wind field. Byram originally provided the equations without any derivation and eventually Nelson (1993) presented derivations based on notes he had from Byram. Both authors emphasized the ratio of the power of the fire to the power of the wind, which they call the convection number,  $N_c$ , rather than the power expressions. Nelson (1993) provided a brief discussion explaining how turbulent mixing and a stable or unstable temperature profile may affect the equations, and Nelson (2003) expanded on these two points.

Byram (1959) provided one example of the power equations applied to an actual fire, using Rhode Island’s Wood River Valley Fire of May 1951. He stated:

...studies have shown that extreme fire behavior and blowup characteristics occur when  $P_f > P_w$  for a considerable height above the fire—usually at least 1000 feet and more, often greater than 3000 or 4000 feet. Possibly one of the most erratic conditions is in the transition zone where  $P_f$  and  $P_w$  are nearly equal.

Three fire case studies (Aronovitch 1989, Simard et al. 1983, Wade and Ward 1973) have included Byram’s powers or convection number. Rothermel (1991) incorporated Byram’s equations into his model for predicting behavior and size of crown fires in the Northern Rockies. In the case studies, authors had to make numerous assumptions about the weather: neutral stability, winds constant over time, winds constant with height, and some calculation of fire intensity, and none of the studies reaches any substantial or verifiable conclusions about the fire’s behavior based on the power of the fire, power of the wind, or convection number. In describing the use of the crown fire nomograms, Rothermel (1991) assumed that windspeed is constant at the 6-m (20-ft) speed and does not adjust for the fire’s rate of spread, even though he stated, “this can produce errors and should not always be assumed.”

Byram’s equations, or Nelson’s more general equations, represent the energy produced by combustion and that contained in the wind field. Application of the equations for case studies has a very low precision, and obtaining the necessary data to apply the equations is nearly impossible for an ongoing fire. Although the National Wildfire Coordinating Group (NWCG) S-490 course objectives discuss estimation of power of the fire and power of the wind, there is no quantitative exercise or explicit discussion of how to estimate them, and it is not listed in the instructor handbook among the topics to be tested.

## Adverse Wind Profiles and Low-Level Jets

Closely related to the power of the wind is Byram’s other well-known contribution to the science of fire behavior, the idea of the “adverse wind profile” (Byram 1954). This is often simply referred to as the “low-level jet.” Byram’s adverse profile/low-level jet concept is taught in all of the NWCG fire behavior classes. The paper discusses turbulence, instability, and the location of the jet stream in the upper troposphere in addition to wind profiles, but it is the windspeed profiles that remain widely known and remembered.

Byram examined the wind profiles measured near 17 fires. He identified nine profile types from the 17 fires and noted that six of the profiles were associated with extreme fire behavior. Furthermore, he noted that there were differences in fire behavior within any profile type and associated those differences with the height of the low-level jet above the ground. Notably, his type 1-a profile, “one of the most dangerous types that can exist from the standpoint of personnel safety and erratic and unpredictable fire behavior” has no jet in it. In addition to discussing the windspeed profile, Byram stated, “The direction profile is an extremely important part of the complete wind profile,” but did not provide an explanation of the directional profiles. The figures show a variety of directional profiles, as well as changes in those profiles during the fires.

Subsequent discussions of Byram’s profiles appear in Steiner (1976) and Brotak (1976). Steiner’s discussion is in general terms and does not reach any particular conclusions. Brotak (1976) considered 62 “large and extremely serious” wildfires in the Eastern United States and found that only one-third of the fires considered displayed such a jet.

The variety of wind profiles, both in terms of speed and direction, are so great that one could not definitively or authoritatively associate any observed wind profile with just one of Byram’s adverse wind profiles. Rather than trying, one could note the general structure Byram described as related to blow-up fires:

- Windspeed of 18 mi/h or more measured in the “free air” at the elevation of, or slightly above, the fire’s elevation.
- Wind decreasing with height for several thousand feet above the fire with the possible exception of the first few hundred feet.

Although the general concept of the low-level jet or the adverse wind profile has moved into the realm of common usage, no one has explained or demonstrated why or how it influences a fire’s behavior. Byram (1959) did not do so, he solely described how he identified it in conjunction with the fires he examined. It is possible to hypothesize on ways the profile interacts with the plume updraft or descending rear

inflow, and there are studies of thunderstorm dynamics that can lend insight, but there is no work at present that clearly shows why or how Byram’s wind profiles would lead to extreme fire behavior or blow-up fires.

The earlier discussion of Byram’s power of the fire and power of the wind equations noted the case studies that used them assumed constant winds with height. The low-level jet seen in Byram’s most dangerous profiles directly contradicts this assumption. Using constant winds underestimates the power of the wind and therefore also underestimates the value of the power of the fire necessary to yield a convection number,  $N_c$ , greater than 1. The only operational application of the Byram wind profiles is subjective assessment of observed profiles.

### Stability and Instability

Few fire managers or fire researchers doubt that there is a connection between atmospheric stability and extreme fire behavior. The idea first appeared in Foley (1947), followed by Crosby (1949), and Byram and Nelson (1951). Davis (1969) examined stability accompanying 70 fires in Arkansas, Alabama, Louisiana, Mississippi, and Tennessee using broad stability and fire size classes. Later, Brotak and Reifsnnyder (1977) found that unstable air above a fire was present for a number of large fires. Haines (1988b) used these observations as the basis of his Lower Atmosphere Severity Index, now known widely as the Haines Index. Potter (2002) discussed atmospheric stability influences on the circulation created by a fire and showed that greater instability leads to stronger updrafts and surface winds, and that the influence is greater when the instability is closer to the ground. In terms of basic physics, an unstable atmosphere provides less resistance than a stable atmosphere to the ascent of hot air in the fire’s plume and is more conducive to general mixing of air between the ground and regions higher up.

Instability itself cannot directly influence the combustion process—it must be converted into wind. Nor can instability directly start a fire—it may enable thunderstorms that produce lightning, but that is an indirect connection

and is not related to extreme fire behavior. In addition to the circulation that a fire in an unstable environment creates, instability can influence a fire by allowing existing windy or dry air from upper levels to more easily reach the ground where it can interact with the fuels and combustion. Foley (1947), Crosby (1949), and Byram and Nelson (1951) all connected instability to fire behavior through the turbulence and high winds it can produce and transport downward to the fire. Brotak and Reifsnyder (1977), Haines (1988b) and Potter (2002) all included some measure of moisture aloft in their discussions of instability. It was Brotak and Reifsnyder's (1977) correlation between low moisture aloft and large fire occurrence at the ground that led to its inclusion in the Haines Index.

Davis (1969), Brotak and Reifsnyder (1977) and Haines (1988b) did not examine fire behavior qualities: intensity, rate of spread, or flame length. Rather, Davis considered stability at the time of fires over 120 ha (300 ac) provided to him by state fire control staff. Brotak and Reifsnyder looked at atmospheric properties present at the time of "large" fires, defined as larger than 2000 ha (5,000 ac). Haines' fire data included 74 fires reported by wildland fire management units as "their worst situations over 20 [years]." How to translate these to the concept of extreme fire behavior, if it is even possible to do so, is not clear. The Haines Index is the only quantitative measure of stability used in wildland fire management to indicate the regional potential for fires to become large or display erratic behavior. This application is consistent with its origins and derivation. There are other stability indices used for thunderstorms (such as the K, Lifted, Showalter, SWEAT, and the Total Totals indices) or smoke dispersion (such as the Lavdas Atmospheric Dispersion Index), but none of these have been scientifically evaluated for use in predicting extreme fire behavior, or fire behavior of any kind.

Much remains unknown about instability's influence on fire behavior. Is it possible to separate instability's influence on plume strength (and subsequently ground-level inflow winds) from the relationship between instability and turbulence? Heilman and Bian (2010) showed that multiplying

the Haines Index by the surface turbulent kinetic energy (TKE) differentiates fires larger than 400 ha (1,000 ac) from smaller fires better than the Haines Index does alone, suggesting that it is the turbulence generated by the instability that matters for fire size, but does not rule out plume strength as an additional contributing factor. In addition, the questions noted above regarding moisture interactions with instability and which measures of fire behavior are influenced by instability are subjects needing further research. Although answers to these questions may prove useful, there is sufficient evidence of instability's ties to extreme fire behavior to justify great caution by fire management when unstable conditions exist.

## Downbursts and Plume Collapse

In meteorology, a downburst is both a broad description of a family of phenomena and a specific member of that family. The fire behavior community generally uses the broader definition: "An area of strong, often damaging winds produced by one or more convective downdrafts over an area from less than 1 to 400 km in horizontal dimensions." (AMS 2000) The physical processes driving a downburst rely critically on moisture in the plume and, to an extent, on the vertical wind profile. Details of the downburst process can be found in Houze (1993) and other books describing the dynamics of severe storms.

The related term "plume collapse" (sometimes called column collapse) evokes vivid images of towering smoke plumes rising upward and then falling back toward the ground. The origins of the term in the fire community are unclear. There is no official definition in the fire community for plume collapse, nor does there appear to be any generally agreed upon standard. The idea of plume collapse is taught in S-290 and in more detail in S-390, but there is no single stated definition in those curricula, nor is there a definition in the NWCG Glossary of Wildland Fire Terminology. The S-390 precourse work still references the *Fire Weather* handbook (Schroeder and Buck 1970) that includes a discussion of the air mass thunderstorm concept—a highly idealized simplification—suggesting that this is the intended use of the term for wildland fire management.



For the present discussion, plume collapse is a special case of a downburst. In plume collapse, the energy source driving the updraft is cut off or ceases, and the updraft decays or reverses its motion, producing a downburst. A downburst, more generally, is a strong, short-lived down-draft that occurs near the continuing updraft, **not necessarily including the loss of the driving energy source or the cessation of the main updraft**. This is compatible with the equivalence of plume collapse and dissipating convection in the current S-390 course.

At the ground, the symptoms of a downburst are a rapid but brief period where the wind dies down, followed by a sudden gust of winds radiating out from the center of the sinking air. There may be precipitation at the ground or signs of precipitation aloft, such as virga. The area underneath the precipitation is the most likely candidate for the center of the sinking air. Air temperatures may drop suddenly at the ground, but this may be difficult to detect near a fire and will occur at the same time as the arrival of the wind gust.

Downbursts associated with fire behavior appear in the fire literature going back to Cramer (1954), although that paper calls them thundersqualls. There and in Schroeder and Buck (1970) and Haines (1988a), discussion focused on downbursts generated by nearby thunderstorms, not by the fire column itself. Haines (1988a) noted that downbursts with heavy precipitation are more common in the Eastern United States, labeling them “wet downbursts.” Dry downbursts, in contrast, are more common in the arid regions of the United States where the precipitation may evaporate before reaching the ground.

Goens and Andrews (1998) hypothesized that the fatalities on the 1990 Dude Fire resulted from a fire-generated downburst driving the fire on the heels of the fleeing fire crew. They presented fire behavior observations and meteorological observations consistent with the development of such a downburst. The observations included light precipitation at the ground, a strong convection column, and a calm just before the downburst. The downburst, when it came, brought winds of 18 to 27 m/s (40 to 60 mi/h) and lasted

only a few minutes. In this instance, topography added to the danger of the downburst. The air in a downburst is denser than the air around it, so it will flow downhill. If that flow runs into the fire, it will carry the fire downhill with it at speeds more typical of an uphill run.

The only reference to plume (column) collapse in the scientific literature on wildland fires is Fromm and Servranckx (2003). They referred to the Chisolm Fire in 2001, and the use of the term “convective collapse” is not clarified; it appears to mean that the plume top, which had been well above the tropopause, sank down to be closer to the tropopause. Because the reported surface winds at this time were between 30 and 50 km/h (20 and 30 mi/h), the top of the convective plume would have been well downwind of the fire when this occurred, and the event does not qualify as plume collapse under the definition stated above. There is no clear evidence that collapse near the tropopause led to fire behavior changes at the ground.

It is clear that the processes involved in plume collapse are poorly understood, but that does not negate the importance of the characteristics frequently attributed to plume collapse. Firsthand observations of showers of embers, increasing smoke, or sudden changes of wind and fire spread are not in question, and many people have observed these. What is questionable or unknown is what caused these things to happen, whether it in any way relates to the idea of plume collapse as defined here, or what factors control the timing and location of these processes. Haines (1988a) listed several fires where thunderstorm downbursts were considered responsible for firefighter fatalities and extreme fire behavior. The Dude Fire study by Goens and Andrews (1998) appears to be the only case study specifically documenting a downburst created within the fire’s plume. There is no doubt that downbursts can cause extreme fire behavior.

The useful questions about downbursts center on understanding when the temperature, wind, and moisture profiles at a fire favor the occurrence of downbursts and whether those conditions can be predicted with sufficient lead time to allow any action. The wind profile interacts

with temperature and moisture in complex ways, influencing when downdrafts occur and where they occur relative to the updraft. The question of precisely when or where a downburst will occur relative to the fire is much more difficult to answer and of limited value for operational purposes. If the possible location of the downburst and its influence on the fire's direction or rate of spread change more rapidly than resources or fire crews can adapt, then simply knowing it can occur is more useful information.

Although there is no scientific study of plume collapse (as defined here) in wildland fires, management anecdotes and physics both support it as a sound explanation for some situations, notably the stage in slash burns when the fire's energy output ceases or drops off rapidly. The stated significance of plume collapse in the NWCG fire behavior courses indicates the potential value in scientific study of just what conditions can yield plume collapse. The ambiguity and imagery inherent in the phrase "plume collapse" remain problematic, however. Eliminating the term "plume collapse" in the context of fire behavior and just discussing "downbursts" could reduce confusion.

## Summary

Although scientific studies provide a consistent qualitative picture of the fire's plume, the quantitative tools associated with plume structure are less robust. Operationally, there are two significant limitations on applying even qualitative relationships of plume dynamics to extreme fire behavior. The first is the fact that all of the plume aspects discussed here require information on the three-dimensional structure of the atmosphere before they can serve as a basis for action. Practitioners must either have experience and intuition that allow them to accurately understand and predict the changing nature of the atmosphere in three dimensions, or else they must have access to numerical model data that tell them the current and future structure of the atmosphere. The second limitation is that although the plume dynamics and indices discussed here have to some degree been documented accompanying extreme fire behavior, there is no scientific study showing that they are absent during

nonextreme fire behavior events. For example, it is entirely possible that one or more of Byram's adverse wind profiles occurs on every fire, no matter how small. If an index or process is just as common during nonextreme fire behavior as it is during extreme fire behavior, then the potential false alarm rate for that property is quite high and its value to the management community proportionally diminished.

## Literature Cited

- American Meteorological Society. 2000.** Glossary of meteorology. 2<sup>nd</sup> ed. Boston, MA: American Meteorological Society. 850 p.
- Aronovitch, B.B. 1989.** Forecasting wildfire "blow-up." In: Proceedings, 10<sup>th</sup> conference on fire and forest meteorology. Boston, MA: American Meteorological Society and Society of American Foresters: 391–399.
- Banta, R.M.; Olivier, L.D.; Holloway, E.T.; Kropfli, R.A.; Bartram, B.W.; Cupp, R.E.; Post, M.J. 1992.** Smoke-column observations from two forest fires using Doppler LIDAR and Doppler radar. *Journal of Applied Meteorology*. 31: 1328–1349.
- Brotak E.A. 1976.** A synoptic study of the meteorological conditions associated with major wildland fires. New Haven, CT: Yale University. Ph.D. dissertation.
- Brotak E.A.; Reifsnyder, W.E. 1977.** An investigation of the synoptic situations associated with major wildland fires. *Journal of Applied Meteorology*. 16(9): 867–870.
- Browning, K.A.; Fankhauser, J.C.; Chalon, J.-P.; Eccles, P.J.; Strauch, R.C.; Merrem, F.H.; Musil, D.J.; May, E.L.; Sand, W.R. 1976.** Structure of an evolving hailstorm. Part V: Synthesis and implications for hail growth and hail suppression. *Monthly Weather Review*. 104: 603–610.
- Byram, G.M. 1954.** Atmospheric conditions related to blowup fires. Station Pap. 35. Asheville, NC: U.S. Department of Agriculture, Forest Service, Southeastern Forest Experiment Station. 34 p.

- Byram, G.M. 1959.** Forest fire behavior. In: Davis, K.P., ed. *Forest fire control and use*. New York: McGraw Hill: 90–123.
- Byram, G.M.; Nelson, R.M. 1951.** The possible relation of air turbulence to erratic fire behavior in the Southeast. *Fire Control Notes*. 12(3): 1–8. (Republished in *Fire Management Today*. 63(3): 46–51.)
- Clements, C.B.; Potter, B.E.; Zhong, S. 2006.** In situ measurements of water vapor, heat, CO<sup>2</sup> fluxes within a prescribed grass fire. *International Journal of Wildland Fire*. 15: 299–306.
- Clements, C.B.; Zhong, S.; Goodrick, S.; Li, J.; Potter, B.E.; Bian, X.; Heilman, W.E.; Charney, J.J.; Perna, R.; Jang, M.; Lee, D.; Patel, M.; Street, S.; Aumann, G. 2007.** Observing the dynamics of wildland grass fires: Fireflux—a field validation experiment. *Bulletin of the American Meteorological Society*. 88(9): 1369–1382.
- Countryman, C.M. 1969.** Project Flambeau: an investigation of mass fire (1964–1967): final report. Berkeley, CA: U.S. Department of Agriculture, Forest Service, Pacific Southwest Forest and Range Experiment Station. 68 p.
- Cramer, O.P. 1954.** Recognizing weather conditions that affect forest fire behavior. *Fire Control Notes*. 15(2): 1–6.
- Crosby, J.S. 1949.** Vertical wind currents and fire behavior. *Fire Control Notes*. 10(2): 12–15.
- Davis, R.T. 1969.** Atmospheric stability forecast and fire control. *Fire Control Notes*. 30(3): 3–4.
- Foley, J.C. 1947.** A study of meteorological conditions associated with bush and grass fires and fire protection strategy in Australia. Bulletin No. 38. Melbourne, VIC: Commonwealth of Australia Bureau of Meteorology. 234 p.
- Foote, G.B.; Frank, J.W. 1983.** Case study of a hailstorm in Colorado. Part III: Airflow from triple-Doppler measurements. *Journal of the Atmospheric Sciences*. 40: 686–707.
- Fromm, M.D.; Servranckx, R. 2003.** Transport of forest fire smoke above the tropopause by supercell convection. *Geophysical Research Letters*. 30(10): 41–1 through 49–4.
- Goens, D.W.; Andrews, P.L. 1998.** Weather and fire behavior factors related to the 1990 Dude Fire near Payson, Arizona. In: *Proceedings, 2<sup>nd</sup> symposium on fire and forest meteorology*. Boston, MA: American Meteorological Society: 153–158.
- Haines, D.A. 1988a.** Downbursts and wildland fires: a dangerous combination. *Fire Management Today*. 49(3): 8–10.
- Haines, D.A. 1988b.** A lower atmospheric severity index for wildland fires. *National Weather Digest*. 13: 23–27.
- Heilman, W.E.; Bian, X. 2010.** Turbulent kinetic energy during wildfires in the North Central and Northeastern US. *International Journal of Wildland Fire*. 19(3): 346–363.
- Hobbs, P.V.; Rangno, A.L. 1985.** Ice particle concentrations in clouds. *Journal of the Atmospheric Sciences*. 42: 2523–2549.
- Houze, R.A., Jr. 1993.** *Cloud dynamics*. San Diego, CA: Academic Press. 573 p.
- Houze, R.A., Jr.; Rutledge, S.A.; Biggerstaff, M.I.; Smull, B.F. 1989.** Interpretation of Doppler-radar displays in midlatitude mesoscale convective systems. *Bulletin of the American Meteorological Society*. 70: 608–619.
- Klemp, J.B.; Wilhelmson, R.B.; Ray, P.S. 1981.** Observed and numerically simulated structure of a mature supercell thunderstorm. *Journal of the Atmospheric Sciences*. 38: 1558–1580.
- Nelson R.M., Jr. 1993.** Byram’s derivation of the energy criterion for forest and wildland fires. *International Journal of Wildland Fire*. 3: 131–138.

- Nelson, R.M., Jr. 2003.** Power of the fire—a thermodynamic analysis. *International Journal of Wildland Fire*. 12(1): 51–65.
- Palmer, T.Y. 1981.** Large fire winds, gases and smoke. *Atmospheric Environment*. 15(10/11): 2079–2090.
- Potter, B.E. 2002.** A dynamics-based view of fire-atmosphere interactions. *International Journal of Wildland Fire*. 11: 247–255.
- Reid D.G.; Vines, R.G. 1972.** A radar study of the smoke plume from a forest fire. Tech. Paper No. 2. Clayton South, VIC, Australia: Commonwealth Scientific Industrial Research Organization, Division of Applied Chemistry.
- Rothermel, R.C. 1991.** Predicting behavior and size of crown fires in the northern Rocky Mountains. Res. Pap. INT-438. Ogden, UT: U.S. Department of Agriculture, Forest Service, Intermountain Research Station. 46 p.
- Schroeder M.J.; Buck, C.C. 1970.** Fire weather. Washington, DC: U.S. Department of Agriculture, Forest Service. 229 p.
- Simard, A.J.; Haines, D.A.; Blank, R.W.; Frost, J.S. 1983.** The Mack Lake Fire. Gen. Tech. Rep. NC-83. St. Paul, MN: U.S. Department of Agriculture, Forest Service, North Central Forest and Range Experiment Station. 36 p.
- Steiner, J.T. 1976.** Blowup fires—the Byram wind profile. *Australian Meteorological Magazine*. 24(3): 139–142.
- Taylor, R.J.; Bethwaite, F.D.; Packham, D.R.; Vines, R.G. 1968.** A meso-meteorological investigation of five forest fires. Tech. Paper No. 18. Melbourne, Australia: CSIRO Division of Meteorological Physics. 19 p.
- Taylor R.J.; Corke, D.G.; King, N.K.; MacArthur, D.A.; Packham, D.R.; Vines, R.G. 1971.** Some meteorological aspects of three intense forest fires. Tech. Pap. No. 21. Melbourne, Australia: CSIRO Division of Meteorological Physics.
- Taylor, R.J.; Evans, S.J.; King, N.K.; Stephens, E.T.; Packham, D.R.; Vines, R.G. 1973.** Convective activity above a large-scale bushfire. *Journal of Applied Meteorology*. 12(7): 1144–1150.
- Wade, D.D.; Ward, D.E. 1973.** An analysis of the Air Force Bomb Range Fire. Res. Pap. SE-105. U.S. Department of Agriculture, Forest Service, Southeast Forest Experiment Station. 38 p.

## Chapter 6: Spot Fires

Brian E. Potter<sup>1</sup>

### Introduction

Spotting is specifically cited in the National Wildfire Coordinating Group (NWCG) definition of extreme fire behavior. It also qualifies as extreme fire behavior under the working definition used for this synthesis because its irregularity and unpredictable nature are inherently not steady state. Spotting and spot fires are dangers to fire management because of the ember showers they create near the main fire front and their potential to cross substantial barriers.

The following discussion of spotting addresses what is known of the process itself, the tools available to managers, and the primary areas for further research and tool development. Specific papers are cited when appropriate, but there are many more studies in the scientific literature that are related to spotting but not cited here. Readers looking for a more detailed discussion of the science should consult Koo et al. (2010) and Ellis (2000), both of which are themselves valuable resources, but also because they contain many relevant references.

### The Spotting Process

To understand the factors that influence spotting, consider the life cycle of an ember or fire brand. The ember starts as a leaf, twig, seed, nut, or pine cone, piece of bark, or small fragment of a larger piece of fuel that was partially consumed. It may originate on the ground, in the understory, or in the canopy. The air currents associated with the fire must lift the ember up into the fire's plume, until the air currents or gravity throw it out of the updraft. (See chapter 5 for a more detailed description of the air currents associated with the fire's updraft.) As the ember falls to earth, the winds continue to push it horizontally—and perhaps vertically, if it gets caught in an eddy. All through this journey, the ember continues to burn, losing mass and getting smaller. (If it stops burning, there is no longer a spotting hazard.)

As the ember shrinks, it is more easily pushed and carried by the wind, and it settles toward the ground more slowly. Eventually, however, the ember reaches the ground or perhaps it comes to rest in a tree canopy or understory vegetation. If it lands in flammable fuel, it may ignite that fuel if the ember has enough energy to dry and heat the fuel to the combustion point. That drying and heating may take some time, resulting in an ignition delay. At this point, the ember has started a spot fire.

Now consider not just the one ember, but all of the embers generated by a fire. At any time there can be many embers in the air around a fire. The size, shape, and number of embers depend on the fuel type and the intensity of the fire. Some fuels, such as eucalypts and chaparral, produce embers in abundance. Eucalypts also produce some of the most aerodynamic embers, strips of bark capable of sailing long distances (McArthur 1967). Grasses, owing to their fineness and short consumption time, produce fewer embers that survive to return to the ground.

Some embers, especially large ones, land relatively close to the main fire front. The closer they land to the front and the longer they take to ignite the recipient fuels, the more likely it is that the main fire front will overrun them and the less likely that they will cause the fire front to “hop” forward. The zone where overrunning occurs has no definite size—it depends on the fire's rate of spread, the fuel moisture, and, again, the fuel type. One can estimate the width of the overrunning zone by multiplying the spread rate of the main fire front times an estimate of the time it takes embers landing in the fuel to establish themselves as new fires. Even in the overrunning zone, however, heavy showers of embers can gradually dry and heat the fuels so that the fire spreads more rapidly when the main front arrives. Fire spread models based on measurements of spread in actual forest fires will implicitly reflect any such effects, if spotting occurred on the fires used to develop the model. Spread models based on laboratory measurements,

<sup>1</sup> Brian E. Potter, U.S. Department of Agriculture, Forest Service, Pacific Wildland Fire Sciences Laboratory, Seattle, WA.



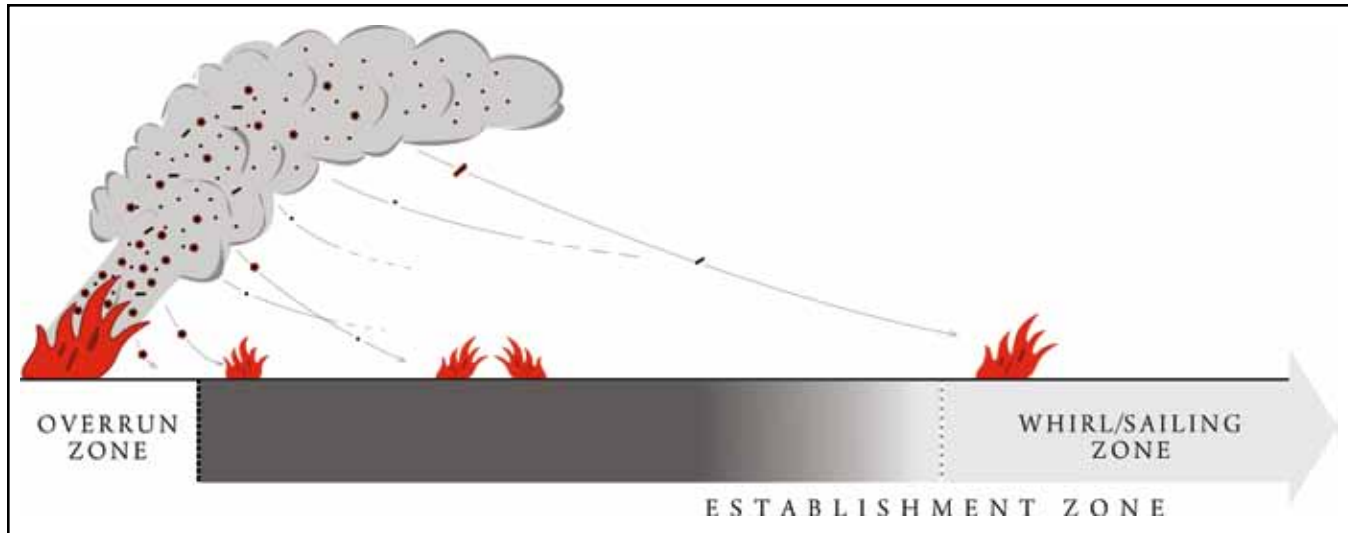

Figure 6-1—Conceptual diagram (not to scale) of the spotting process, illustrating the influence of ember size and shape, lofting height, and ignition. Thin arrows are ember trajectories, those ending in dashed lines indicate the ember burned completely and never reached the ground. Round embers represent woody embers, and the stick-shaped ember leaving the top of the plume represents aerodynamic embers (typically bark) or large embers lofted extremely high by fire whirls or intense surges in the fire.

however, will not include any preconditioning effects from spotting.

Just beyond this zone, there is a chance for embers to ignite a new fire and for that fire to establish itself before the main front arrives. This could be considered the establishment zone, and it extends as far as any embers can travel and still ignite fuels when they alight (fig. 6-1). If there are few embers landing here, they will create spot fires that grow independently of one another and largely independently of the main fire front. Numerous spot fires, however, may form close enough to one another that their heat and air currents will influence one another (see chapter 4). A collection of nearby spot fires that coalesce will grow more rapidly than a fire lit by a single ember (the same principle that lies behind aerial ignition of multiple spot fires.) Just how many embers actually ignite spot fires, or how quickly those fires can grow and merge, depends strongly on the fuel where the embers land. The chance of an ember igniting and growing into a new fire increases as the fine fuel load increases, as the windspeed increases, and as the fuel moisture decreases. It also depends on the fuel species.

Multiple, nearby spot fires may coalesce into one or more larger fires, and depending on where they are relative

to the main fire front, they may remain a separate fire for many days or indefinitely. For example, fires that coalesce across a fire break, across a ridge or valley, or on the flank of the main fire can grow with little chance of merging with the main fire. Spot fires that coalesce ahead of the main fire front with no barrier between, can effectively increase the fire's forward rate of spread. This effect was described in detail in the Wade and Ward (1973) study of the Air Force Bomb Range Fire.

Embers that reach these distances require strong winds and enough vertical lofting that they take a long time to come back to the ground. They must be big enough at the outset to still be burning when they land, yet small enough for the winds to carry them the necessary distance. Embers with low trajectories, primarily carried by horizontal winds, will typically fly out directly ahead of the fire, driven by those same winds. Embers lofted high may experience winds aloft very different from those driving the fire front. Wind direction can vary significantly in the lowest 600 to 900 m (2000 to 3000 ft) of the atmosphere. In the Northern Hemisphere, the wind typically turns to the right as height increases, whereas in the Southern Hemisphere, it tends to turn to the left. There is a recognized tendency for spot

fires to develop on these respective flanks. Complex terrain and strong weather fronts can also modify wind direction at different levels, although less predictably.

There may be some embers that are big or aerodynamic enough to keep burning as they travel great distances, McArthur (1967) cited spot fires up to 29 km (18 mi) for the March 1965 fires in Victoria, Australia. For these embers to get up into the air in the first place, requires substantial vertical wind. Early studies of ember lofting and transport (e.g., Lee and Hellman 1969, Muraszew 1974, Muraszew et al. 1975) concluded that the necessary updrafts had to be of such magnitude and spatial extent that they were physically improbable. For example, Muraszew (1974) calculated that an updraft of 30 m/s, 1 km wide at the ground, only transported embers 7 km. The only way to lift these embers would be in a fire whirl or very intense flareup. (This region is labeled the “whirl/sailing zone” in fig. 6-1.) The embers have to be highly aerodynamic, as well, so that they could sail efficiently on the winds. They would be lofted to such heights that they would almost certainly encounter winds of variable speed and direction, making their ultimate resting place even more difficult to predict.

## **Management Tools**

There are five tools available that translate the complex science of spotting into an operational context. Like any model or tool based on so many interacting processes, these require many assumptions and simplifications. Frank Albini of the USDA Forest Service developed three of the tools, and each addresses a specific type of ember source. The assumptions, simplifications, and limitations of each model are clearly stated and acknowledged in each case. All three provide the same output, an estimate of the maximum spotting distance. One of the other two tools deals with the probability spotting will span a fire break on a grass fire, and the last tool provides an estimate of the minimum spotting distance at which fires can become established before they are overrun.

The first tool is for embers and spotting from single torching trees or groups of up to 30 trees (Albini 1979.) The

calculations estimate the maximum likely spotting distance for such embers, under very specific conditions. The model does not apply to “running crown fires, fires in heavy slash or chaparral under extreme winds, or fires in which fire whirls loft” the embers. It assumes the ember comes from near the top of the torching tree(s). It assumes a specific vertical profile for the wind, one with constant direction and speed increasing from canopy top to a constant value several hundred feet above. Furthermore, it cannot predict the effects of wind eddies caused by terrain, such as lee waves or rotors, or flow in canyons. It assumes the ember is a cylinder of wood, or similar shape. (Laboratory studies by Tarifa et al. (1967) showed that shape is not a major factor most of the time. Cylinders, spheres, and plates of a given density travel roughly the same distance.) The model does not predict the probability of ignition when an ember lands, nor does it predict the number of embers reaching the estimated maximum distance. The model allows lofting up to 305 m (1,000 ft) above ground and predicts distances up to 3.2 km (2 mi) over flat terrain with uniform fuels. Multipliers for nonflat terrain can increase spot distance to as much as 5.6 km (3.5 mi), if the source is atop a 1200-m (4,000-ft) ridge and the distance to the valley bottom exceeds 3.2 km (2 mi).

Albini (1981) modified the torching tool so that it could be used for isolated, more sustained sources such as slash piles or fuel “jackpots.” Although the earlier model assumes a short-lived heat source and a brief surge in the fire’s plume, the newer model allows a more sustained heat source and plume lofting the ember. This model also allows estimation of maximum spotting distance when there is not uniform-height forest along the ember’s flight path. The estimate assumes a neutral or stable atmosphere and still assumes constant wind direction. The strongest plumes and most intense fires, however, tend to develop under conditions with unstable air near the ground: how much this would affect spot distance estimates is not clear.

The third tool/model is from Albini (1983) and extends the earlier models for use with wind-driven surface fires without timber cover. The model assumes the fire is linear,

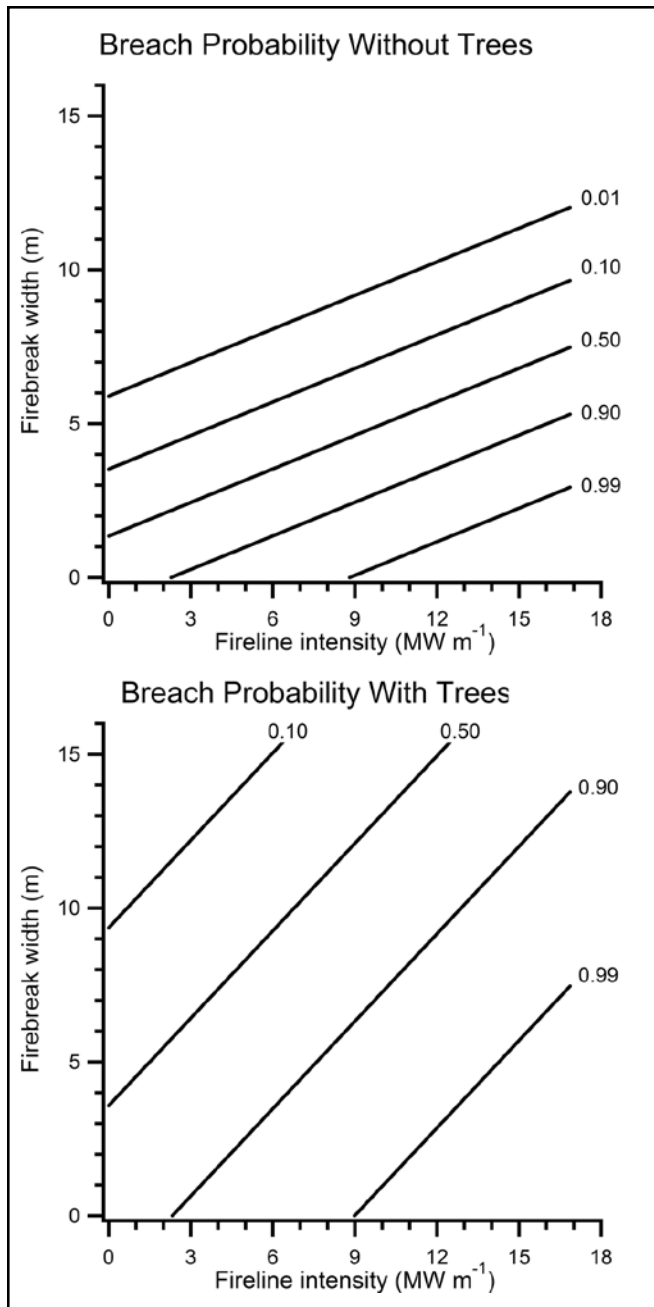

Figure 6-2—Probabilities of breaching firebreaks of specified width as a function of fireline intensity. Based on equations in Wilson 1988.

perpendicular to the wind, and much longer than the front-to-back depth of the flaming front. It also assumes that any embers lofted by a surface fire rise in short surges in fire intensity. This aspect of the model relies on a theoretical model of the duration and strength of the surges, and Albini

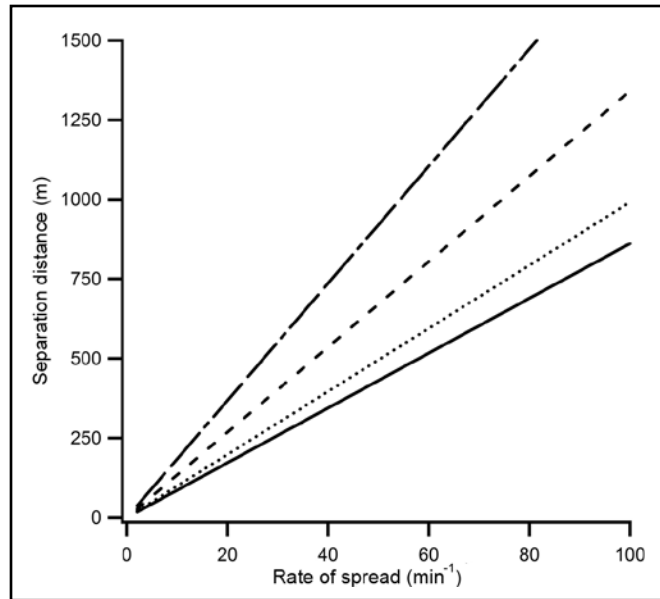

Figure 6-3—Minimum distance at which a spot fire will not be overrun by the main fire. Distance depends on ignition delay and is shown for delays of 0.2 minutes (solid line); 1.5 minutes (dotted line), 5 minutes (dashed line), and 10 minutes (dash-dot line). Following Alexander and Cruz 2006.

said outright “this hypothesis, crucial in the model’s development, is unlikely to ever be tested directly.” The results of this extension only predict the lofting height of embers, which then go into the Albini (1979) model to provide the estimated maximum spotting distance. Albini (1983) did not state whether the surface-fire model still assumes, cylindrical wood embers; if so, it may not be appropriate for grassy fuels without any woody component.

The next tool is a pair of graphs (fig. 6-2) from Wilson (1988) that indicate the probability that a grass fire will spot across a firebreak of given width. Note that this is based on, and only strictly appropriate for, grass fires with very few trees. The only input required is an estimate of the fire’s intensity and whether or not there are trees in the fire perimeter within 20 m of the fire break. The figures (and the equation from which they are derived) indicate the probability the fire will spot across a break of given width.

The last tool is also a graph, and it is for use during active crown fires. Specifically, it is calibrated for use on crown fires in open canopy coniferous fuel types (Forestry Canada Fire Danger Group 1992). Alexander and Cruz

(2006) provided an estimate of the minimum distance at which a newly ignited spot fire will not be overrun by the main fire front. This is essentially the depth of the overrun zone mentioned previously. The graph (fig. 6-3) indicates the distance/depth based on rate of spread and ignition delay (ID). It assumes that once an ember ignites a fire, it will accelerate and achieve 90 percent of its steady-state spread rate in 20 min. Fires that require longer to reach a steady-state rate of spread, including those in a more closed canopy environment, will result in increased separation distances or overrun zone depths.

### **Knowledge Gaps**

There are several opportunities for improvement in both the tools and the underlying science of spot fires. Foremost of these is one basic element: validation or evaluation of how the Albini tools currently perform. Albini stated repeatedly that the models were not tested in the field, and that “assumptions, approximations, and inadequately supported empirical relationships are sprinkled throughout.” There is no published study scientifically evaluating any of the Albini submodels or models in their whole. Two publications (Norum 1982 and Rothermel 1983) cite the use of the models in the field and view them favorably, but neither of these constitutes a rigorous model evaluation.

The science already exists to estimate trajectories in a complex wind field. Smoke and air pollution models regularly and quickly compute trajectories in wind fields that vary in the vertical, horizontal, and time. These could be combined with the lofting and burnout models of Albini (the components most strongly supported by research). The existing tools could also be modified to include more aerodynamic fuels like eucalyptus bark, or lofting by short-lived fire whirls.

These adaptations would still only address maximum distance and direction for single embers, however. The number, size, and spotting density of embers at shorter distances are important for the accurate estimation of spread rate of the main fire front. Before any tools can provide this information, however, basic studies must measure

these properties for various fuel types and fire intensities. Manzello et al. (2007) examined embers produced by single Douglas-fir trees (see “Common and Scientific Names” section), but it is the only study of this nature. Related to this is the need for research on the effect of embers and spotting on preconditioning fuels. Incorporation of this into fire behavior tools would provide the ability to estimate any acceleration of the fire spread in the overrun zone and “hopping” potential in the establishment zone.

There are several studies that examine the probability of an ember igniting fuels after it lands (e.g., Ganteaume et al. 2009; Manzello et al. 2006a, 2006b), and a few consider the time interval between the ember landing and fuels igniting (Alexander and Cruz 2006, Ganteaume et al. 2009). No tool, however, gathers this information and uses it to indicate the delay or probability of ignition for recipient fuels. Such a tool would admittedly require many assumptions about ember size, burning rate, and fuel characteristics, but those assumptions are not necessarily any more of a limitation than the assumptions Albini had to make for the spotting distance models. Overall, there are two basic management implications of the state of knowledge on spot fires. First, the existing tools have clearly stated limitations with respect to when they apply, what they predict, and how certain those predictions are. Users should know the limitations when applying the tools. Taken as a whole, the limitations mean the tools can provide general guidance regarding how far from the main front spot fires can be expected, but they do not claim to be, nor should they be used as, substitutes for lookouts and constant vigilance.

Second, in the absence of scientific information on a particular fuel’s tendency to produce embers or ignite when embers land, local knowledge, familiarity, and observations are essential. The number and size of embers or spot fires, and the observed distance and direction of ember travel are all important pieces of information. If spot fires are close enough together to merge before the main front arrives, or are observed on the flank of the fire, they could produce a new front or a rapid jump in the main front or a flank that could endanger crews.

## Literature Cited

- Albini, F.A. 1979.** Spot fire distance from burning trees—a predictive model. Gen. Tech. Rep. INT-56. Ogden, UT: U.S. Department of Agriculture, Forest Service, Intermountain Forest and Range Experiment Station. 25 p.
- Albini, F.A. 1981.** Spot fire distance from isolated sources—extensions of a predictive model. Res. Note INT-309. Ogden, UT: U.S. Department of Agriculture, Forest Service, Intermountain Forest and Range Experiment Station. 9 p.
- Albini, F.A. 1983.** Potential spotting distance from wind-driven surface fires. Res. Pap. INT-309. Ogden, UT: U.S. Department of Agriculture, Forest Service, Intermountain Forest and Range Experiment Station. 27 p.
- Alexander, M.E.; Cruz, M.G. 2006.** Evaluating a model for predicting active crown fire rate of spread using wildfire observations. *Canadian Journal of Forest Research*. 36: 3015–3028.
- American Meteorological Society [AMS]. 2000.** Glossary of meteorology. <http://amsglossary.allenpress.com/glossary>. (June 16, 2011).
- Ellis, P.F. 2000.** The aerodynamic and combustion characteristics of eucalypt bark—a firebrand study. Canberra, ACT, Australia: Australian National University. Ph.D. thesis.
- Forestry Canada Fire Danger Group. 1992.** Development and structure of the Canadian Forest Fire Behavior Prediction System. Information Report ST-X-3. Ottawa, Ontario, Canada: Forestry Canada, Science and Sustainable Development Directorate. 63 p.
- Ganteaume, A.; Lampin-Maillet, C.; Guijarro, M.; Hernando, C.; Jappiot, M.; Fonturbel, T.; Pérez-Gorostiaga, P.; Vega, J.A. 2009.** Spot fires: fuel bed flammability and capability of firebrands to ignite fuel beds. *International Journal of Wildland Fire*. 18: 951–969.
- Koo, E.; Pagni, P.J.; Weise, D.F.; Woycheese, J.P. 2010.** Firebrands and spotting ignition in large-scale fires. *International Journal of Wildland Fire*. 19: 818–843.
- Lee, S.L.; Hellman, J.M. 1969.** Study of firebrand trajectories in a turbulent swirling natural convection plume. *Combustion and Flame*. 15: 645–655.
- Manzello, S.L.; Cleary, T.G.; Shields, J.R.; Yang, J.C. 2006a.** Ignition of mulch and grasses by firebrands in wildland-urban interface fires. *International Journal of Wildland Fire*. 15: 427–431.
- Manzello, S.L.; Cleary, T.G.; Shields, J.R.; Yang, J.C. 2006b.** On the ignition of fuel beds by firebrands. *Fire and Materials*. 30: 77–87.
- Manzello, S.L.; Maranghides, A.; Mell, W.E. 2007.** Firebrand generation from burning vegetation. *International Journal of Wildland Fire*. 16: 458–462.
- McArthur, A.G. 1967.** Fire behaviour in eucalypt forests. Leaflet 100. Canberra, Australian Capital Territory, Australia: Commonwealth of Australia, Forestry and Timber Bureau, Forest Research Institute.
- Muraszew, A. 1974.** Firebrand phenomena. Aerospace Report ATR-74(8165-01)-1. El Segundo, CA: The Aerospace Corporation. 109 p.
- Muraszew, A.; Fedele, J.B.; Kuby, W.C. 1975.** Firebrand investigation. Aerospace Report ATR-74(7470)-1. El Segundo, CA: The Aerospace Corporation. 104 p.
- Norum, R.A. 1982.** Predicting wildfire behavior in black spruce forests in Alaska. Res. Note PNW-401. Portland, OR: U.S. Department of Agriculture, Forest Service, Pacific Northwest Forest and Range Experiment Station. 10 p.
- Rothermel, R.C. 1983.** How to predict the spread and intensity of forest and range fires. Gen. Tech. Rep. INT-143. Ogden, UT: U.S. Department of Agriculture, Forest Service, Intermountain Forest and Range Experiment Station. 161 p.



**Tarifa, C.S.; del Notario, P.P.; Moreno, F.G.; Villa, A.R.**

1967. Transport and combustion of firebrands. Final report of grants FG-SP-114 and FG-SP-146. Madrid, Spain: Instituto Nacional de Tecnica Aeroespacial. 90 p. Vol. II.

**Wade, D.D.; Ward, D.E. 1973.** An analysis of the Air Force Bomb Range Fire. Res. Pap. SE-105. Asheville, NC: U.S. Department of Agriculture, Forest Service, Southeast Forest Experiment Station. 38 p.

**Wilson, A.A.G. 1988.** Width of a firebreak that is necessary to stop grass fires: some field experiments. Canadian Journal of Forest Research. 18: 682–687.

This page was intentionally left blank.

## Chapter 7: Vortices and Wildland Fire

Jason A. Forthofer and Scott L. Goodrick<sup>1</sup>

### Introduction

Large fire whirls are often one of the more spectacular aspects of fire behavior. Flames flow across the ground like water feeding into the base of the vortex, the lowest thousand feet of which often takes on an orange glow from combusting gases rising within the vortex core. Burning debris lofted within the vortex can lead to a scattering of spot fires some distance from the main fire. With their sudden formation, erratic movement, and often sudden dissipation, fire whirls are a good example of extreme fire behavior. However, other forms of vortices are actually quite common on wildland fires and receive less attention despite their potential to dramatically alter fire behavior.

This chapter is designed to provide a better understanding of vortices associated with wildland fires, both fire whirls and horizontal roll vortices. A key point will be providing a basic understanding of what aspects of the fire environment contribute to the development and growth of these vortices. The next section of the chapter supplies a

brief introduction to vorticity, a measure of the atmosphere's tendency to spin or rotate about some axis. With this basic understanding of vorticity, we will examine the common vortex forms described in the fire behavior literature, fire whirls and horizontal roll vortices.

### Vorticity Basics

Simply stated, vorticity is the measure of spin about an axis. That axis can be vertical, as in the case of a fire whirl, or horizontal for a roll vortex, or somewhere in between. Figure 7-1 is an idealized illustration of a cross section through a fire with no ambient horizontal wind. The vertical winds near the ground can be characterized by a strong updraft over the fire and descending air outside of the fire area. The change in the vertical velocity across the fire imparts rotation to the flow field about an axis perpendicular to the page. Horizontal vortices form at both edges of the fire area and rise along the edge of the plume. While rising, these vortices can grow and will transfer energy to other vortices, which is one way that atmosphere dissipates energy.

<sup>1</sup> Jason A. Forthofer, USDA Forest Service, Missoula Fire Sciences Laboratory, Missoula, MT.

Scott L. Goodrick, U.S. Department of Agriculture, Forest Service, Southern Research Station, Athens, GA.

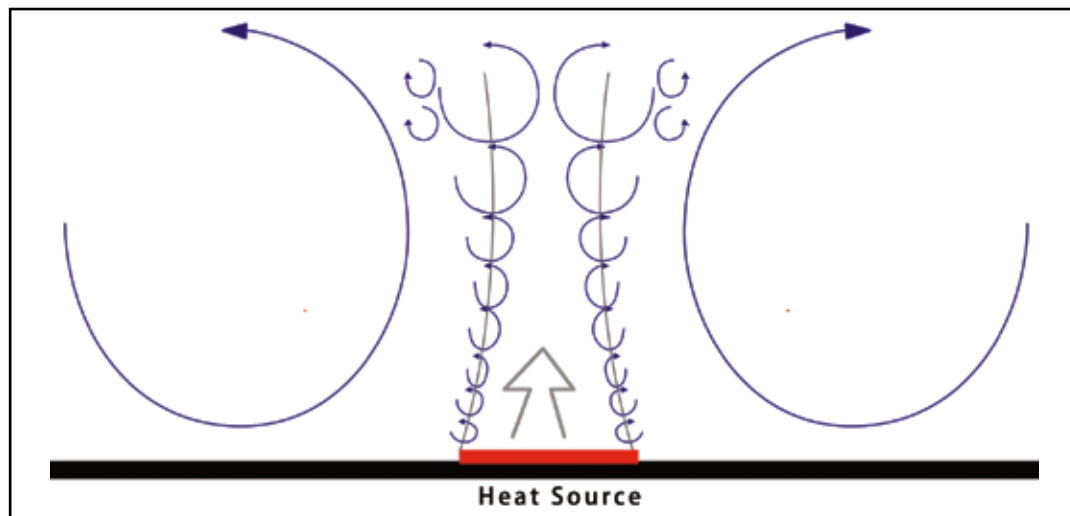

Figure 7-1—Cross section through idealized fire illustrating occurrence of vortices owing to horizontal gradient of vertical motion produced by buoyancy from the fire.

The change of vorticity can be described by the following equation where the terms on the righthand side of the equation can be grouped as either modifying terms or producing terms.

$$\text{Vorticity} = (\text{Transport} + \text{Tilting} + \text{Stretching})_{\text{modifying}} + (\text{Baroclinic} + \text{Shear} + \text{Body})_{\text{producing}} \quad (1)$$

The first group of terms in equation 1 can modify vorticity that is already present in the atmosphere, but cannot create new areas of rotation. Transport is the process by which the mean wind can move vorticity from one area to another. Tilting involves changing the orientation of the axis of rotation (e.g., a horizontal vortex can be tilted into a vertical orientation). As will be shown later, this is an important process for wildland fires. The third term, stretching, can modify a vortex by changing the magnitude of the vorticity (how fast it rotates). The first two terms, transport and tilting, are only capable of moving or reorienting a vortex, but not strengthening or weakening one. A converging airflow, such as indraft feeding a fire, acts to strengthen a vortex by concentrating its circulation about a smaller radius, much like ice skaters spinning faster when pulling their arms in.

The producing terms on the righthand side of equation 1 describe processes that create areas of rotation within the atmosphere. The baroclinic term generates vorticity in cases where the gradients in pressure and density are not parallel. In the case of a fire, rapid heating develops a horizontal temperature gradient that is not aligned with the vertical static pressure gradient. This misalignment of the vertical pressure gradient and horizontal thermal gradient leads to rotational motions to mix warm and cold fluid in an attempt to restore balance. The shear term describes the generation of vorticity from viscous shear stress. Wind shear induced by surface drag is a source of vorticity; therefore, if the wind is blowing at the earth's surface, horizontal vorticity is being generated. The final producing term in equation 1 represents changes in vorticity from body forces such as gravity acting on the fluid.

In summary, the vorticity at any location changes owing to the transport of vorticity from one place to

another, the tilting of vorticity from one axis to another, the stretching and intensifying of vortices by convergence, or by the generation of vorticity through buoyancy or wind shear.

## Fire Whirls

Fire whirls are vertically oriented, intensely rotating columns of gas found in or near fires. They have been observed in wildland, urban, and oil spill fires and volcanic eruptions. Dynamically they are closely related to other swirling atmospheric phenomena such as dust devils, waterspouts, and tornadoes (Emmons and Ying 1967). Fire whirls have also been called fire devils, fire tornadoes, and even fire-nados. They are usually visually observable because of the presence of flame, smoke, ash, or other debris. The definition of a fire whirl used here includes those whirls caused by the buoyancy of a fire but with no inner core of flame. Fire whirls range in size from less than 1 m in diameter and velocities less than 10 m/s up to possibly 3 km in diameter and winds greater than 50 m/s (Goens 1978). The smaller fire whirls are fairly common, whereas the larger whirls are less common. All fire whirls, especially the larger ones, represent a considerable safety hazard to firefighters through increased fire intensity, spotting, erratic spread rate and direction, and wind damage (Emori and Saito 1982, Moore 2008, U.S. Bureau of Land Management 2006).

Several extremely large fire whirls have been reported in urban fires that illustrate their potentially destructive nature. In 1871, the Great Chicago Fire generated whirlwinds that lifted and transported burning planks 600 m ahead of the main fire, which contributed greatly to the spread and destruction of the fire (Musham 1941). On the same day, a fire in Peshtigo, Wisconsin, generated a whirl that was strong enough to lift a house off its foundations (Gess and Lutz 2002). Hissong (1926) also reported a whirl strong enough to move a house. This whirl was one of many that formed during a large oil storage facility fire. The whirl separated from the fire and moved 1000 m downwind, lifted a small house, and moved it 45 m killing the two residents inside. A much more devastating whirl formed in 1921 when

a magnitude 7.9 earthquake hit the Tokyo, Japan, area causing a mass urban fire. This fire spawned an extremely large fire whirl that killed an estimated 38,000 people in less than 15 min (Soma and Saito 1988). The victims had gathered in an area of sparse fuel 0.16 km<sup>2</sup> in size, and the whirl moved over the area. Last, the World War II city bombings of Hamburg, Dresden, and Hiroshima were reported to have caused very large and destructive fire whirls. The Hamburg whirl was estimated at 2.4 to 3 km in diameter and 5 km tall (Ebert 1963).

Large and intense fire whirls also occur on wildland fires. Graham (1952, 1955, 1957) described several large whirls that were able to lift large logs and other debris and break off large standing trees. He indicated that many form on lee slope locations. Pirsko et al. (1965) reported on a very intense fire whirl that moved out of the fire area in the downwind direction and destroyed two homes, a barn, three automobiles, toppled almost 100 avocado trees, and injured four people. They also believed that the terrain and lee slope location contributed to the formation of the whirl. Additionally they cited moderate winds, an unstable atmosphere, and a large heat source as contributors. King (1964) analyzed video of a fire whirl and found that maximum vertical velocities in the whirl core were up to 91 m/s. Large fire whirls have also been documented on flat ground. Haines and Updike (1971) described several medium to large fire whirls that occurred during prescribed fires on flat ground. They cited a super-adiabatic lapse rate in the lower atmosphere as an important factor. Umscheid et al. (2006) also reported on a large fire whirl that occurred on flat ground and gave convincing arguments that a major contributor to the whirl was vorticity associated with passage of a cold front. Billing and Rawson (1982) also reported on a large whirl that may have been influenced by a cold front passage. McRae and Flannigan (1990) described many large whirls that occurred on prescribed fires. One of the largest and most intense whirls was 400 m in diameter and ripped standing trees out of the ground and lifted them upward. This whirl occurred on a cloudy day with a temperature lapse rate of -6 °C/1000 m in the first 1000 m above the

ground. They concluded that the influence of the environmental lapse rate on fire whirl formation is unclear and that whirls can form under lapse rates other than dry or super adiabatic.

Fire whirls have severely injured firefighters in the past. Emori and Saito (1982) described a wildland fire in Japan that may have spawned a fire whirl that injured firefighters. The 2001 Fish Fire in Nevada generated a fire whirl that caused firefighters to deploy their fire shelters (U.S. Bureau of Land Management 2001). Another whirl in 2006 in Nevada injured six firefighters (U.S. Bureau of Land Management 2006). Finally, a very large whirl formed on the 2008 Indians Fire in California that injured four firefighters (Moore 2008).

### Fire Whirl Physics

Over the past few decades, a significant body of information has accumulated on fire whirl structure and influencing factors. The different techniques used to investigate fire whirls include field and laboratory-scale experiments, as well as analytical, physical, and numerical modeling. This work has revealed some of the main features of fire whirls. For example, it is commonly accepted that the formation of fire whirls requires a source of ambient vorticity and a concentrating mechanism (Emmons and Ying 1967, Goens 1978, Meroney 2003a, Zhou and Wu 2007). Ambient vorticity in the atmosphere can be generated at the ground through wind shear, horizontal density gradients, and from the Earth's rotation. The concentrating mechanisms in fires are produced by the buoyant flow. It reorients horizontal vorticity into the vertical direction and provides vortex stretching.

### Vorticity Sources

In the wildland fire context, there are many possible sources of ambient vorticity that could contribute to fire whirls. Morton (1966) discussed some of these sources. One important source may be the shear layer that develops when ambient wind flows over the ground surface, producing horizontally oriented vorticity. This type of vorticity generation



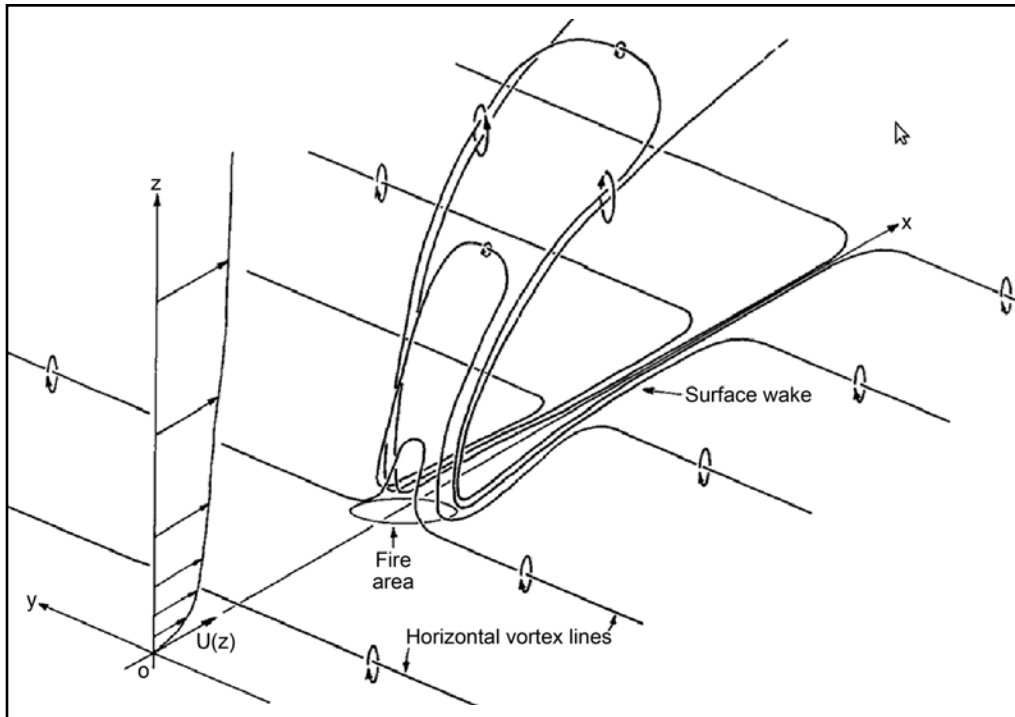

Figure 7-2—A schematic showing how shear-generated horizontal vorticity present in the atmosphere near the ground can be reoriented to the vertical by a fire (from Church et al. 1980).

corresponds to the shear term on the righthand side of equation 1. As shown in figure 7-2, this horizontal vorticity can then be reoriented, or tilted, by the fire's buoyant flow into the vertical (Church et al. 1980, Cunningham et al. 2005, Jenkins et al. 2001) and may be a major contributor to many fire whirls. Similarly, it is likely that the indrafting to a buoyant plume develops a shear layer near the ground that also generates horizontally oriented vorticity that can be tilted to the vertical. This source of vorticity could be present even in zero ambient wind situations. Complex terrain can also generate vorticity through channeling and shear of ambient and fire-induced winds (Pirsko et al. 1965). Turbulent wake regions behind terrain features such as hills and mountains are thought to produce favorable vorticity for fire whirls (Countryman 1964, 1971; Goens 1978; Graham 1957). Another source of ambient vorticity for some whirls may be vorticity present along frontal boundaries (Billing and Rawson 1982, Umscheid et al. 2006). This may be similar to the meteorological setting for many non-mesocyclone tornadoes (Umscheid et al. 2006).

Another possible source of vorticity in fire whirls is the baroclinic term in equation 1. At this time, it is unclear how important this source of vorticity is to fire whirls. McDonough and Loh (2003) provided an initial examination using numerical modeling. They mainly examined grid resolution requirements and were not able to make any strong conclusions about the significance of baroclinically generated vorticity, other than that it warrants further study.

### Vortex Stretching

The primary vorticity-concentrating mechanism in fire whirls appears to be vortex stretching owing to vertically accelerating flow in the whirl core (Snegirev et al. 2004). The vertical acceleration is due to buoyant forces from hot gases in the core of the fire whirl. This acceleration causes a reduction in the diameter of a horizontal area enclosed by a chain of fluid particles (horizontal convergence), thereby increasing nonzero vorticity at any location on the horizontal area (Jenkins et al. 2001). This is analogous to a reduction in the moment of inertia of a rotating solid, causing increased rotation rate to conserve angular momentum.

Snegirev et al. (2004) indicated that the whirl core radius is not dependent on the initial or imposed circulation, but that it is probably dependent on vortex stretching owing to vertical acceleration.

This same mechanism may also contribute to reduction in whirl vorticity (Snegirev et al. 2004) high up in the vortex where the vertical velocity decreases with height. This could occur when the core's buoyancy is reduced from ambient air entrainment or encountering a stable atmospheric lapse rate aloft. The vertical deceleration would reduce the vorticity.

### Increased Combustion Rates

A number of researchers have noted significant increases in burning rates of laboratory fire whirls (Byram and Martin 1962, Chuah et al. 2009, Emmons and Ying 1967, Martin et al. 1976). In all of these studies, the burning rate is defined as the mass loss rate of the fuel source (solid or liquid). Byram and Martin (1962) found a threefold increase in alcohol burning rate when a whirl formed. Emmons and Ying (1967) found that the burning rate of their acetone pool fires was a function of the externally imposed circulation, with increases of up to seven times the nonwhirl conditions. Martin et al. (1976) measured burning rates in fires fueled by cross-piled wood sticks of varying sizes that were 1.4 to 4.2 times the nonwhirl fire rate.

### Scaling Fire Whirls

Much of what is known about fire whirls comes from small-scale laboratory experiments. Full-scale experiments are usually not practical because of safety concerns, economic aspects, and difficulties of controlling boundary conditions (Emori and Saito 1982). Because of this, scaling laws are very important to consider when attempting to apply information gained from small-scale experiments to full-scale fire whirls. Several authors have examined scaling related to fire whirls.

Kuwana et al. (2007, 2008) examined several experimental and full-scale whirls and concluded that a critical crossflow wind velocity exists where fire whirls are most

likely to occur. This critical velocity was found to be proportional to the vertical buoyant velocity, which depends on the burning rate and length scale of the burning area.

### Fire Whirls in the Real World: Common Features

Many factors appear to influence the development of fire whirls on wildland fires. These factors interact in complex ways, and it is doubtful that firefighters will ever have very accurate predictive tools to foresee whirl formation, especially in a timely manner to make real-time decisions. The hope at this point is to identify situations that are more likely to form whirls. The following are some likely scenarios where fire whirls have been known to form. It is probable that some of these types of fire whirl scenarios could combine to possibly make whirl formation more likely or more intense.

#### Whirl Shedding on the Lee Side of a Plume

This type of whirl forms when a plume is subjected to a crossflow wind. The whirl forms on the lee side of the plume. It separates from the plume and advects in the downwind direction. It is similar in appearance to Von Karman vortex shedding behind an obstruction in a flow. Often, as the whirl moves away from the fire, it contains no flaming combustion. Wind in the whirl can be strong enough to cause damage to trees, structures, vehicles, etc., and the whirl may stay intact for several minutes and travel for distances of possibly 1.6 km (1 mi). Its ability to stay intact even though most of its vortex stretching mechanism (buoyancy) is lost is probably due to the strong reduction in turbulent diffusion of the core. Examples of this type of whirl have been reported by many authors (Church et al. 1980; Clements et al. 2008; Dessens 1962; Hissong 1926; Pirsko et al. 1965; Soma and Saito 1988, 1991) and video and images of others are on file at the U.S. Forest Service Missoula Fire Sciences Laboratory.

It is probable that a critical crossflow wind velocity is very important to this type of fire whirl, as discussed in the section on scaling firewhirls. Its main source of vorticity

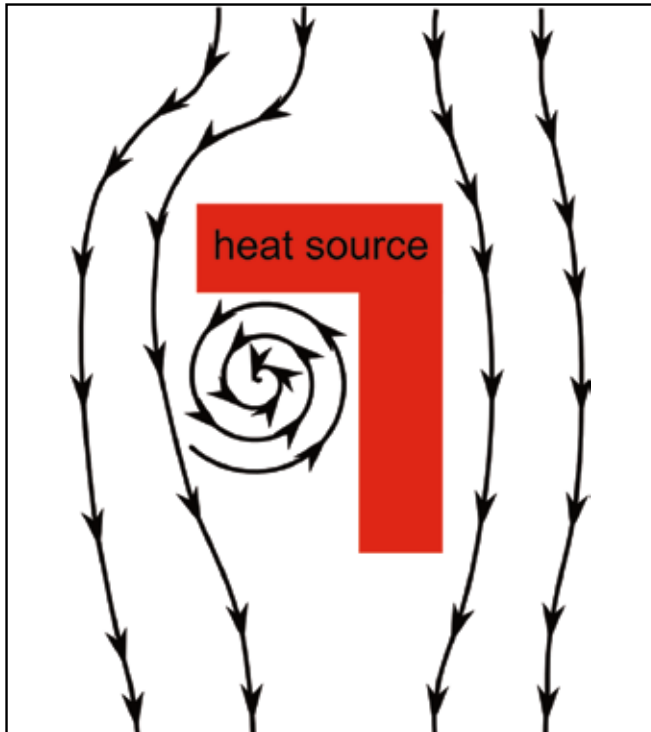

Figure 7-3—Schematic of fire whirl formation for an L-shaped heat source in a crossflow wind. View is from above.

may come from the tilting of horizontally oriented, shear-generated vorticity in the ambient crossflow. The significance of other sources of vorticity is currently unknown. Others (Fric and Roshko 1994, McMahon et al. 1971, Moussa et al. 1977) have shown that the same shedding whirles are present in an isothermal vertical jet in crossflow, giving some credibility to the notion that the main source of vorticity comes from the shear-induced ambient vorticity

### L-Shaped Heat Source in Crossflow

Soma and Saito (1988, 1991) first investigated this type of fire whirl as an explanation for a historic and catastrophic fire whirl that occurred in 1923 in Tokyo. Unlike the shedding whirl, this type of whirl seems to be mostly stationary. It occurs when a roughly L-shaped heat source is subjected to a crossflow wind as shown in figure 7-3. The whirl forms in the inside bend of the L-shaped heat source. As in the shedding whirl, a critical crossflow windspeed is thought to be important (Soma and Saito 1988, 1991). If the

wind is above or below this speed, whirles are less likely to form. This type of whirl is probably very much related to the shedding whirl type, including the important vorticity source from the ambient shear flow.

### Vorticity Associated With Cold Fronts

This type of whirl forms when ambient vertical vorticity from cold fronts interacts with a fire plume. Billing and Rawson (1982) and Umscheid et al. (2006) discussed cases where this type of whirl formed over flat terrain. The key feature of these two examples is that they occurred almost exactly when a cold front passed over the fire area. Umscheid et al. (2006) discussed the associated ambient vertical vorticity present along a cold front boundary and identified some similarities between this type of fire whirl and the formation mechanisms of non-mesocyclone tornadoes. At this time, it is not clear why fire whirles form under some cold front passage conditions, but not others. Perhaps non-mesocyclone tornado genesis research can help identify why these whirles form.

### Multiple Interacting Plumes

This type of fire whirl occurs from the interaction of multiple plumes with no ambient crossflow wind. Entrainment into each plume is affected by the nearby plumes, and under the correct configuration and buoyant plume strengths, a whirl can form. Figure 7-4 shows a schematic of how five fires could be oriented to cause a fire whirl. Lee and Otto (1975) observed whirl formation owing to plume interaction in their experiment using two asymmetric burning wood piles. Zhou and Wu (2007) examined the multiple interacting plume whirl in more detail using experimental fires, numerical simulation, and some scaling analysis. They discussed configurations under which whirles would and would not form. They also showed that whirles can form under randomly oriented plume locations (fig. 7-5). This has implications for wildland fire under mass ignition conditions. Occurrence of fire whirles under such conditions might be very likely, so long as the multiple plumes are drafting a significant amount of air and are properly spaced and organized.

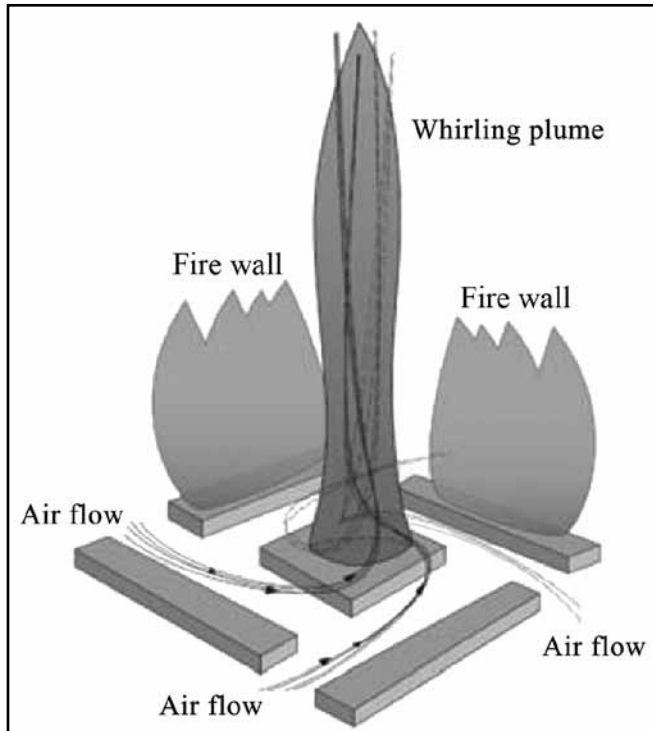

Figure 7-4—Schematic showing one configuration that can cause a multiple interacting plume type fire whirl (from Zhou and Wu 2007).

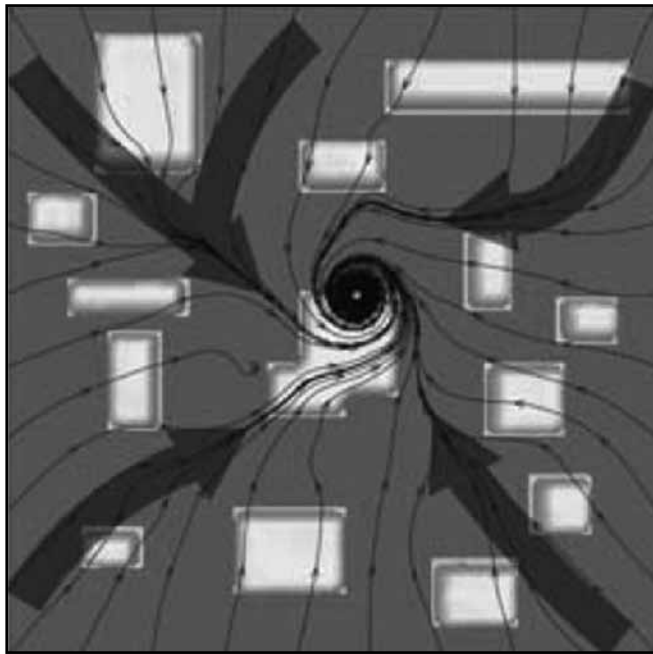

Figure 7-5—A computer simulation showing how randomly oriented heat sources could cause a fire whirl through plume interactions (from Zhou and Wu 2007).

### Lee Side of a Hill/Mountain

These fire whirls occur when a fire plume exists on the lee side of a terrain obstruction such as a hill or mountain. The plume uses vorticity existing in the wake region of the obstruction to form the whirl. Countryman (1971) stated that this is the most favorable situation for generation of fire whirls. During investigations of full-scale mass fires, Countryman (1964) intentionally burned a fire on a lee slope under moderate wind to investigate this type of whirl. Several whirls formed during the burn, with the largest occurring near the end. Pirsko et al. (1965) described a whirl that formed on the lee side of a terrain obstruction and then shed from the plume in the downwind direction. The whirl caused significant wind damage to several houses, trees, and vehicles. Windspeed at the time was 9.4 m/s (21 mi/h) with gusts to 13 m/s (29 mi/h).

### Horizontal Vortices

Horizontal vortices are quite common in the atmosphere and have been extensively studied (see Brown [1980] and Etling and Brown [1993] for reviews). In the absence of wind, when the ground is heated, the warm air near the ground will eventually begin to rise in circulation cells, a process known as Rayleigh-Bernard convection (Fernando and Smith 2001). In the presence of vertical wind shear, these cells begin to transition from disorganized and transient to an organized state: hexagonal lattice of convective cells. Fair-weather cumulus clouds often mark the tops of updrafts of these cells. As the wind shear increases, the convective cells further organize into horizontal convective rolls that are perpendicular to the mean wind; further increases in the vertical wind shear change the balance between buoyancy-driven vorticity and shear-driven vorticity and lead to the convective rolls being oriented parallel to the mean wind (Küettner 1971). These longitudinal convective rolls are easily seen in satellite images as parallel bands of cumulus clouds known as cloud streets. Figure 7-6 illustrates the structure of these cloud streets. Although such horizontal convective rolls are a common feature of the atmosphere in the planetary boundary layer, the presence of

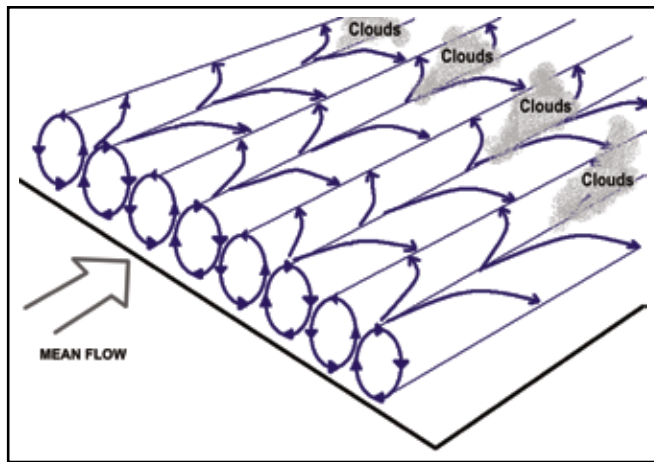

Figure 7-6—Illustration of the role of horizontal vortices in the development of cloud streets (based on Etling and Brown 1993).

a fire adds a complicating factor in the form of a horizontal temperature gradient that can locally alter the convective organization of the boundary layer.

Horizontal vortices associated with wildland fires have received less attention than their vertical counterparts, fire whirls. Haines and Smith (1987) provided descriptions of three distinct types of horizontal vortices observed on wildland fires: the transverse vortex, which is perpendicular to the flow direction; a single longitudinal (flow parallel) vortex; and a counter-rotating longitudinal vortex pair.

### Transverse Vortices

Transverse vortices are described by Haines and Smith (1987) as a series of vortices “climbing” the upwind side of the convective column under conditions of low ambient windspeeds and intense burning. The mechanism Haines and Smith (1987) proposed for the development of such vortices involves the development of buoyancy-forced ring vortices rising through the smoke column. Haines and Smith (1987) further hypothesized that only the upwind portion of the ring is clearly visible, as turbulent mixing is thought to render the downwind section of the ring less distinct. Transverse vortices on wildland fires have received little attention, but extensive literature is available on ring vortices associated with pool fires.

The buoyancy-forced ring vortex is a common feature of fluid flows associated with heat sources ranging in scales from candles to pool fires up to large mass fires; however, they are most clearly visible under conditions of weak mean horizontal flow. For these ring vortices, the vorticity is generated through the baroclinic term from equation (1). Because the thickness of the density layer controls the magnitude of the baroclinically forced vorticity, the strongest vortices have scales similar to that of the flame surface (Cheung and Yeoh 2009). As buoyant forces cause these vortices to rise, a process often referred to as “amalgamation” takes place as the rising vortices merge and grow and manifest themselves in the oscillatory necking and bulging of the fire that results from the Rayleigh-Taylor instability. The same basic process can be observed at the scale of the smoke plume, leading to the development of the transverse vortices described by Haines and Smith (1987). The oscillatory nature of the development of these vortices has been extensively studied for pool fires (Cetegen and Ahmed 1993); however, little has been done at the scale of wildland fire events.

Although descriptions of vortex rings are quite common in the literature, little is mentioned about transverse vortices outside of Haines and Smith (1987). These vortices manifest themselves on the upwind side of the plume and add a boiling appearance to the plume. Although the vortices themselves are not a source of erratic fire behavior, their presence is an indicator of a potential increase in the rate of combustion and an associated change in fire behavior.

### Longitudinal Vortices

#### Single longitudinal vortex—

Longitudinal vortices differ from their transverse counterparts in that their axis of rotation is oriented parallel to the mean flow. The first class of longitudinal vortices from Haines and Smith (1987) is the single longitudinal vortex, of which only one case is presented, the Dudley Lake Fire as described by Schaefer (1957). The vortex was oriented in the direction of the mean flow, which was quite strong that day as surface winds were between 16 and 22 m/s. The



diameter of the vortex was estimated at 1800 m. Smoke entrained within the vortex delineated the corkscrewlike nature of the vortex and allowed the vortex to be observable 500 km downwind. The scale of this vortex is similar to those of the convective boundary layer rolls responsible for cloud streets and shows strong similarities to roll vortices associated with other crown fires (Haines 1982) with the main exception being that this was only a single vortex.

A possible answer to the question of why only a single vortex was observed may be answered through the numerical modeling work of Heilman and Fast (1992). In this study, a computer model of the atmospheric boundary layer was initialized with multiple heat sources some distance apart to examine how circulations induced by each heat source interacted and how the collection of these flows responded to the introduction of a transverse wind component (wind blowing perpendicular to the axis of the roll vortices). The introduction of the transverse wind component tended to destabilize the longitudinal vortices, and, in some cases, eliminated the upwind vortex entirely. Haines and Smith (1992) similarly found in their wind tunnel studies that a slight transverse component to the flow destabilized the vortex pair, causing the collapse of the downwind (relative to the transverse wind component) vortex, which on a wildland fire would cause the vortex to fall outward across the flank of the fire, providing an additional mechanism for lateral fire spread and a threat to firefighter safety. On the Dudley Lake Fire, Schaefer (1957) observed that at regular intervals, the outward/downward moving segments of the vortex would mark lateral surges in the fire growth, indicating the possible presence of some slight shifts in the wind that may have inhibited the presence of the other vortex.

This vortex type differs from the other two types described by Haines and Smith (1987) in that the fire is not necessarily an integral forcing term in the development of the vortex. Conditions in the atmosphere may already favor the development of the convective rolls, and the fire may simply act to enhance the vortex through additional thermal instability. Although the transverse vortices are most pronounced at low windspeeds, the Dudley Lake vortex was

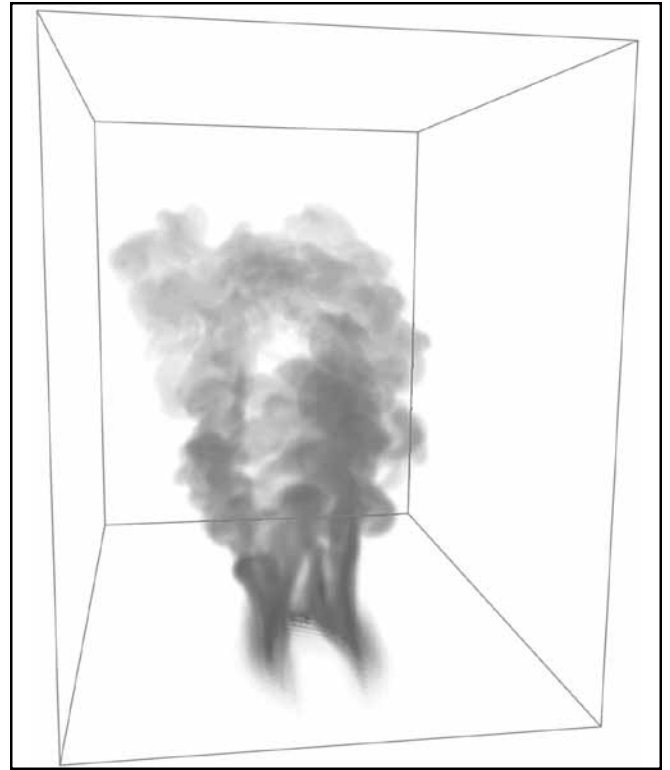

Figure 7-7—Bifurcated smoke plume from a computer simulation. View is from upwind of the fire (from Cunningham et al. 2005).

accompanied by surface winds of 16 to 22 m/s (the mean windspeed for the 12 crown fire cases in Haines 1982 was 5.5 m/s).

#### **Counter-rotating, longitudinal vortex pair—**

Of the three types of horizontal vortices described by Haines and Smith (1987), the counter-rotating, longitudinal vortex pair is the best documented, although early work (Scorer 1968, Turner 1960) focused on vortex pairs associated with smokestack emissions rather than wildland fires. The key feature of this vortex type is obviously the paired nature of the vortices rotating in opposite directions. These vortices often occur along the flanks of the fire and can also be observed in the main plume at the head of the fire; this is often referred to as a bifurcating smoke column. Figure 7-7 shows a numerical simulation of a bifurcated smoke plume as viewed from behind the fire. Cunningham et al. (2005) showed that the degree to which the smoke plume splits is related to the depth of the surface shear layer.



The New Miner Fire in central Wisconsin in 1976 is one example of a bifurcated smoke column provided by Haines and Smith (1987). This fire burned under very low relative humidity conditions for the region (minimum of 23 percent) with light winds averaging around 2 m/s. The bifurcated column consisted of a pair of vortices approximately 30 m in diameter that rotated fairly slowly compared to other atmospheric whirls like tornadoes. These columns would intermittently collapse and spill over the fire's flanks, bringing hot gases and embers into contact with unburned fuels and providing for rapid lateral spread. Obviously, such behavior is a threat to fire crews that often focus their suppression efforts along the flanks of the fire. A key difference between these vortex pairs and the single vortex is the scale; the bifurcated columns were approximately 30 m in diameter, whereas the vortex on the Dudley Lake Fire was over 1 km.

As part of a 1979 study conducted at the Centre de Recherches Atmosphériques Henri Dessens in France, Church et al. (1980) studied the vortices produced by the Météotron, an array of 105 oil burners with a total heat output of 1000 MW. Three types of vortices were observed: (1) a columnar vortex that had the entire smoke column rotating, (2) small dust-devil-like vortices just downwind of the burner array, and (3) a large, counter-rotating vortex pair within the plume that started as vertical vortices at the burn site, but became horizontal and oriented parallel to the wind as the plume rose and moved downwind. The first two vortex types are vertical vortices as described in the section on fire whirls.

The last type resembles the bifurcating column described for the New Miner Fire. At a height of 40 to 50 m, the smoke column of the Météotron experiment bifurcated into a pair of counter-rotating vortices with initial diameters of 30 to 60 m (Church et al. 1980). The dominant motion associated with these vortices was rotation about their axis with little noticeable motion along the axis, a stark contrast to the strong axial flow observed in many fire whirls.

The forcing of the counter-rotating vortex pair is complex and has parallels with the forcing of similar vortex

pairs by nonbuoyant jets in a crossflow (see Margason 1993 for a review). The split plume develops through the interaction of the ambient vorticity in the flow owing to vertical wind shear with the jet shear layer (or plume shear layer in the case of wildland fires). The presence of buoyancy adds additional complexity to the forcing of the split plume compared to the nonbuoyant jet. Church et al. (1980) put forth a pair of physical processes capable of describing the development of the bifurcating smoke column. The first process focuses on the reorientation and stretching of the horizontal vorticity in the ambient flow. Initially, the ambient vorticity can be thought of as a collection of horizontal tubes oriented perpendicular to the wind with upward motion along the upwind side of the tube and downward motion along the downwind side. As these vortex tubes encounter the rising air at the fire, the portion of the tube over the fire is lifted, which acts to tilt the vortex tube at the edge of the fire into a vertical orientation, producing a hairpin-like shape. As the lifted portion of the vortex tube continues to rise in the plume, it encounters stronger horizontal winds that transport this portion of the tube downwind faster than the surface parts, stretching the arms of the hairpin vortex. Eventually the combined processes of the lifting and faster downwind transport leads to the majority of the hairpin vortex being oriented horizontal and parallel to the mean flow. This is illustrated in figure 7-2.

The second process proposed by Church et al. (1980) deals with the generation of vorticity through the combined effects of buoyancy and surface drag forces. This process is actually a variation on the buoyant rings discussed earlier. The variation is the impact of the crossflow on the rising ring vortex. On the upwind edge of the ring, the crossflow enhances entrainment of ambient air on that side of the plume, which decreases the vertical velocity of that part of the plume. This causes the downwind section of the ring to rise faster than the upwind side, tilting some of the vorticity into a vertical orientation. The downwind section also encounters the stronger winds aloft before the upwind side, which leads to a stretching/intensifying of the streamwise sections of the ring. Experiments by Tsang (1970, 1971)

support the viability of this method in generating the counter-rotating vortex pair.

Although both physical processes are plausible explanations for the development of the counter-rotating vortex pair, both are not equally supported by the observations. Many of the observed fire plumes exhibited significant near-surface vertical vorticity, which is best supported by the first process, which relies upon the reorientation of ambient vorticity (Cunningham et al. 2005). Wind tunnel studies of the longitudinal vortex pair offer further support for the ambient vorticity process, as Smith et al. (1986) found the vorticity in the streamwise vortex pair to agree quite well with the vorticity of the ambient flow as it approached the heat source. This is not to suggest that the buoyancy generated from the fire has no impact, just that it is not the dominant forcing for the development of the vortex pair.

Numerical modeling studies of the longitudinal vortex pair have largely been two dimensional (Heilman and Fast 1992; Luti 1980, 1981; Porteiro et al. 1999) or quasi-three dimensional (streamwise flow component assumed constant) where the governing equations are solved for a number of planes perpendicular to the streamwise flow (McGratten et al. 1996, Trelles et al. 1999, Zhang and Ghoniem 1993). Cunningham et al. (2005) conducted the first fully three-dimensional simulation of fire plumes to focus on the development of vortical structures. Their simulations revealed the relationship among the depth of the shear layer, fire intensity, and the behavior of the vortex pair. The basics of this relationship centered around how long it took a buoyant air parcel to traverse the shear layer. Keeping the mean crossflow constant, a deeper shear layer would lead to a wider split of the smoke column. If the fire intensity is increased, the air parcels travel through the shear layer faster, which leads to a decrease in the width of the plume split. One interesting observation is that for a given fire intensity, the plume rise is not affected by the width of the smoke column's bifurcation, although its horizontal spread and deviation from a Gaussian distribution is strongly affected.

Another aspect of the counter-rotating vortex pair described by the numerical simulations of Cunningham et al. (2005) is the potential for oscillations, with each branch periodically exhibiting dominance. These oscillations were linked with localized regions of vertical vorticity of alternating signs being shed from either side of the plume in a manner similar to wake vortices observed for fluid flowing around a cylinder. These results were limited to a narrow range of flow parameters, but the simulations indicate that the counter-rotating vortex pair are not necessarily stable. Wind tunnel studies using a heated wire to mimic the flank of a crown fire have shown that perturbations in the flow component perpendicular to the mean flow can cause the vortex pair to collapse (Haines and Smith 1992). These flow perturbations could be caused by upstream topographic features, possibly groups of trees, or even natural shifts in the ambient wind.

In the previous discussion, the wind profile reflected typical conditions where windspeed increased with height. Byram (1954) noted that a number of major fire runs occurred when the windspeed decreased with height near the surface, a condition known as an adverse wind profile. Clark et al. (1996) examined the potential impact of an adverse wind profile on fire spread through the use of a three-dimensional coupled fire-atmosphere model. In their simulations, a counter-rotating vortex formed through the reorientation of the ambient boundary layer vorticity as described above; however, this time, the rotation was in the opposite direction (see figure 7-2 of Clark et al. 1996), which leads to narrow regions of hot, high-speed air shooting out of the fire front. This dynamic fingering occurred at scales of the order of tens of meters and has the potential to augment fire spread.

### **Tree Crown Streets**

Some fires exhibit complex patterns of alternating strips of burned and unburned fuel, often referred to as tree crown streets. One possible explanation for the development of tree crown streets involves horizontal roll vortices (Haines 1982). It is hypothesized that on one side of the vortex,

descending air cools the fuels and causes surface winds to diverge, thus inhibiting crown fire spread. On the other side of the vortex, upward motion is enhancing the convective column owing to the associated surface wind convergence, which can in turn enhance a spreading crown fire. Tree crown streets are cited as evidence for the presence of horizontal roll vortices on the Mack Lake Fire (Simard et al. 1983). Wade and Ward (1973) observed complex patterns of intermittent strips of unburned fuel in the Air Force Bomb Range Fire and suggested some potential hypotheses for these patterns including brief fluctuations of windspeed or direction, or pulsations of long-range spotting linked to an erratic convective column. Although often considered a fingerprint for the presence of horizontal roll vortices, the exact cause of tree crown streets is not known.

## Summary

Vorticity describes the degree of rotation in the atmosphere about some axis. Two factors that induce rotation in the atmosphere are wind shear and sharp horizontal gradients in temperature. Once one of these factors has generated vorticity, that vorticity can be transported by the mean wind to other locations, reoriented from one axis to another (a horizontal vortex can be tilted to become a vertical vortex), or enhanced by flow convergence that stretches the vortex. It is rare for the atmosphere to be completely devoid of vorticity. If the wind is blowing at all, there is vorticity produced near the ground by surface drag. Terrain features provide flow obstacles whose drag produces wind shear, thus generating vorticity. Different ground surfaces heat at different rates, which also generates vorticity. Vortices are present across a broad spectrum of spatial scales, continuously transferring energy between scales, mostly from large scales to smaller scales. A fire not only interacts with and modifies this ambient vorticity, but also generates additional vorticity.

For convenience in our discussion of wildland fire vortices, we split our discussion into vertical and horizontal vortices. Vertical vortices, often referred to as fire whirls, are often the most dramatic and often-described type of

vortex. Fire whirls, especially the larger ones, represent a considerable safety hazard to firefighters, as these vortices can result in sudden increases in fire intensity, spotting, erratic spread rate and direction, and damaging winds. Most often, the source of vorticity for a fire whirl is not the fire itself; rather, the vorticity is present in the ambient atmosphere. This ambient vorticity may be generated by wind shear, vortex shedding in the wake of a plume or topographic obstruction, or an approaching cold front. The fire plays a much more important role in modifying the ambient vorticity field by tilting horizontal vortices toward the vertical, and increasing the vorticity magnitude through the stretching term as surface flow converges at the fire to feed the strong updraft.

Similarly, two of the three horizontal vortex types described by Haines and Smith (1987) rely on ambient vorticity. The counter-rotating vortex pair builds upon the tilting and stretching vortex modifications that enable a fire to transform horizontal vorticity generated by wind shear into a vertically oriented fire whirl. The key addition is stronger winds above the surface that sweep the upper part of the hairpin vortex described in figure 7-2 downwind, bending the vortices back toward a horizontal orientation. For the single longitudinal vortex described for the Dudley Lake Fire, the fire is interacting with vorticity on a much larger scale, a boundary layer roll whose depth can occupy the entire mixed layer. Again the fire's role is one of modifying the vortex, which can in turn modify the fire environment by changing windflow patterns near the fire and creating a positive feedback loop leading to fire intensification.

Vortices are common features of the atmosphere occurring across a broad range of spatial scales. Our understanding of how wildland fires interact with this broad spectrum of atmospheric vortices is still very much in development. Table 7-1 summarizes the various vortices described in the text along with their causes and potential threats. Although the occurrence of these vortices is currently impossible to predict with precision, having a basic understanding of the importance of ambient atmospheric vorticity for vortex

**Table 7-1—Summary of vortices, their causes, and potential threats**

Phenomenon	Causal factor(s)	Potential danger
Fire whirl formation on the lee side of a plume	Shear-generated vorticity near the ground is concentrated and reoriented to the vertical on the lee side of the plume.	Increased energy release rate, spread rate, and spotting. The whirl could travel downwind from the fire and overtake firefighters.
Fire whirl formation near an L-shaped fire in a crossflow wind	Shear-generated vorticity near the ground is concentrated and reoriented of the vertical on the lee side of the L, as shown in figure 7-3.	Increased energy release rate, spread rate, and spotting. The whirl could suddenly form in the “interior” area of L.
Fire whirl formation near a cold front	Vorticity along the frontal boundary is concentrated in to a fire whirl.	Increased energy release rate, spread rate, and spotting.
Fire whirl formation owing to multiple interacting fire plumes	The indrafting and blocking effects of of multiple interacting fire plumes concentrates vorticity that was likely shear generated near the ground.	Increased energy release rate, spread rate, and spotting. Whirl could build into a fire storm.
Fire whirl formation on the lee side of a hill/mountain	Vorticity associated with the wake region of a terrain obstruction such as a hill or mountain is concentrated into a fire whirl.	Increased energy release rate, spread rate, and spotting. The fire could quickly switch from a sheltered, backing fire with low fire behavior to more extreme fire behavior. The whirl could travel downwind from the fire and overtake firefighters.
Transverse vortex on upwind side of smoke column	Horizontal vorticity is produced through buoyancy.	Not a source of erratic fire behavior, but rather an indicator of a potential increase in the rate of combustion and an associated change in fire behavior.
Single longitudinal vortex	Unstable atmosphere and strong winds generate horizontal vortices with axis parallel to the wind direction. Vortex formation is not tied to the fire.	Slight variations in wind direction can destabilize the vortex, causing the vortex to fall outward across the flank of the fire, providing a mechanism for lateral bursts in fire spread.
Counter-rotating longitudinal vortex pair	Transverse ambient vorticity from surface wind shear is altered by the fire as it is tilted into the vertical and reoriented to the longitudinal direction. Evident as a bifurcated smoke plume.	Can produce concentrated wind bursts at the head of the fire front. The vortices are not always stable as variations in wind direction can cause one of the vortices to collapse and bring hot gases and fire brands into contact with the unburned fuel.

development provides some guidance on situations that require awareness. Examining surrounding topography relative to the expected wind direction, can reveal features that may block or channel the flow. Wind profiles, when available, can provide information on wind shear as can watching direction and speed of cloud movements and their organization (are the clouds forming in lines?). Things

to observe include (1) the behavior of the fire and smoke plume. Vortices are almost always present along the flaming front at some scale. (2) Vortices that grow or persist. (3) Signs of rotation or splitting in the smoke plume. This information is not sufficient for predicting the occurrence of intense vortices on wildland fires, but it can help identify potentially hazardous conditions.

## Knowledge Gaps

Vortices in the atmosphere occur across a broad range of scales and may impact wildland fires in numerous ways. Vortices on wildland fires can develop rapidly, and their behavior is quite erratic and difficult to predict. As with tornadoes, understanding the environmental conditions that favor vortex formation is the first step to understanding the phenomenon. However, in the case of fire-related vortices, an important aspect not shared with tornadoes is the coupling between the fire and the ambient vorticity field. As highlighted in the fire whirl scaling section, a relationship exists—between the vigor of the vertical motions induced by the fire and the ambient crossflow—that describes a range of windspeeds that would support whirl development. Further investigation of this relationship and similar relationships that exist for horizontal vortices would provide a sound basis to develop management tools for assessing the potential for vortex development on a fire.

## Literature Cited

- Billig, P.; Rawson, R. 1982.** A fire tornado in the sunset country. Report 11. Victoria, BC: Forests Commission, Fire Research Branch.
- Brown, R.A. 1980.** Longitudinal instabilities and secondary flows in the planetary boundary layer: a review. *Reviews of Geophysics and Space Physics*. 18: 683–697.
- Byram, G.M. 1954.** Atmospheric conditions related to blowup fires. Station Paper 35. Asheville, NC: U.S. Department of Agriculture, Forest Service, Southeastern Forest Experiment Station. 31 p.
- Byram, G.M.; Martin, R.E. 1962.** Fire whirlwinds in the laboratory. *Fire Control Notes*. 33(1): 13–17.
- Cetegen, B.G.; Ahmed, T.A. 1993.** Experiments on the periodic instability of buoyant plumes and pool fires. *Combustion and Flame*. 93: 157–184.
- Cheung, S.C.P.; Yeoh, G.H. 2009.** A fully-coupled simulation of the vortical structures in a large-buoyant pool fire. *International Journal of Thermal Sciences*. 48: 2187–2202.
- Chuah, K.H.; Kuwana, K.; Saito, K. 2009.** Modeling a fire whirl generated over a 5-cm-diameter methanol pool fire. *Combustion and Flame*. 156: 1828–1833.
- Church, C.R.; Snow, J.T.; Dessens, J. 1980.** Intense atmospheric vortices associated with a 1000 MW fire. *Bulletin of the American Meteorological Society*. 61(7): 682–694.
- Clark, T.L.; Jenkins, M.A.; Coen, J.L.; Packham, D.R. 1996.** A coupled atmosphere-fire model: role of the convective Froude number and dynamic fingering at the fireline. *International Journal of Wildland Fire*. 6(4): 177–190.
- Clements, C.B.; Zhong, S.; Bian, X.; Heilman, W.E.; Byun, D.W. 2008.** First observations of turbulence generated by grass fires. *Journal of Geophysical Research*: 113. D22102. DOI: 10.1029/2008JD010014.
- Countryman, C.M. 1964.** Mass fires and fire behavior. Res. Pap. PSW-19. Berkeley, CA: U.S. Department of Agriculture, Forest Service, Pacific Southwest Forest and Range Experiment Station. 53 p.
- Countryman, C.M. 1971.** Fire whirls: why, when, and where. Res. Note PSW-216. Berkeley, CA: U.S. Department of Agriculture, Forest Service, Pacific Southwest Forest and Range Experiment Station. 6 p.
- Cunningham, P.; Goodrick, S.L.; Hussaini, M.Y.; Lin, R.R. 2005.** Coherent vortical structures in numerical simulations of buoyant plumes from wildland fires. *International Journal of Wildland Fire*. 14: 61–75.
- Dessens, J. 1962.** Man-made tornadoes. *Nature*. 193(4810): 13–14.
- Ebert, C.H.V. 1963.** Hamburg's fire storm weather. *National Fire Protection Association Quarterly*. 56(3): 253–260.

- Emmons, H.W.; Ying, S.J. 1967.** The fire whirl. In: Proceedings of the 11<sup>th</sup> international symposium on combustion. Pittsburgh, PA: Combustion Institute: 475–488.
- Emori, R.I.; Saito, K. 1982.** Model experiment of hazardous forest fire whirl. *Fire Technology*. 18(4): 319–327.
- Etling, D.; Brown, R.A. 1993.** Roll vortices in the planetary boundary layer: a review. *Boundary-Layer Meteorology*. 65: 215–248.
- Fernando, H.J.S.; Smith, D.C.I. 2001.** Vortex structures in geophysical convection. *European Journal of Mechanics - B/Fluids*. 20(4): 437–470.
- Fric, T.; Roshko, A. 1994.** Vortical structure in the wake of a transverse jet. *Journal of Fluid Mechanics*. 279: 1–47.
- Gess, D.; Lutz, W. 2002.** Firestorm at Peshtigo: a town, its people and the deadliest fire in American history. New York: Henry Holt Publishing.
- Goens, D.W. 1978.** Fire whirls. Tech. Memo. NWS WR-129. Missoula, MT: National Oceanic and Atmospheric Administration.
- Graham, H.E. 1952.** A firewhirl of tornadic violence. *Fire Control Notes*. 13(2): 22–24.
- Graham, H.E. 1955.** Fire whirlwinds. *Bulletin of the American Meteorological Society*. 36(3): 99–103.
- Graham, H.E. 1957.** Fire-whirlwind formation as favored by topography and upper winds. *Fire Control Notes*. 18(1): 20–24.
- Haines, D.A. 1982.** Horizontal roll vortices and crown fires. *Journal of Applied Meteorology*. 2: 751–762.
- Haines, D.A.; Smith, M.C. 1987.** Three types of horizontal vortices observed in wildland mass and crown fires. *Journal of Climate and Applied Meteorology*. 26: 1624–1637.
- Haines, D.A.; Smith, M.C. 1992.** Simulation of the collapse of bent-over vortex pairs observed in wildland fires. *Forest Science*. 38: 68–79.
- Haines, D.A.; Updike, G.H. 1971.** Fire whirlwind formation over flat terrain. Res. Pap. NC-71. St. Paul, MN: U.S. Department of Agriculture, Forest Service, North Central Forest Experiment Station.
- Heilman, W.E.; Fast, J.D. 1992.** Simulations of horizontal roll vortex development above lines of extreme surface heating. *International Journal of Wildland Fire*. 2: 55–68.
- Hissong, J. 1926.** Whirlwinds at oil-tank fire, San Luis Obispo, California. *Monthly Weather Review*. 54: 161–163.
- Jenkins, M.A.; Clark, T.; Coen, J. 2001.** Coupling atmospheric and fire models. In: Johnson, E.A.; Miyanishi, K., eds. *Forest fires: behavior and ecological effects*. San Diego, CA: Academic Press. 598 p.
- King, A.R. 1964.** Characteristics of a fire-induced tornado. *Australian Meteorological Magazine*. 44: 1–9.
- Küettner, J.P. 1971.** Cloud bands in the atmosphere. *Tellus*. 23: 404–425.
- Kuwana, K.; Sekimoto, K.; Saito, K. [et al.]. 2007.** Can we predict the occurrence of extreme fire whirls? *American Institute of Aeronautics and Astronautics Journal*. 45(1): 16–19.
- Kuwana, K.; Sekimoto, K.; Saito, K.; Williams, F.A. 2008.** Scaling fire whirls. *Fire Safety Journal*. 43: 252–257.
- Lee, S.L.; Otto, F.W. 1975.** Gross vortex activities in a simple simulated urban fire. *Symposium (International) on Combustion*. 15(1): 157–162.
- Luti, F.M. 1980.** Transient flow development due to a strong heat-source in the atmosphere. I. Uniform temperature source. *Combustion Science and Technology*. 23: 163–175.



- Luti, F.M. 1981.** Some characteristics of a two-dimensional starting mass fire with cross flow. *Combustion Science and Technology*. 26: 25–33.
- Margason, R.J. 1993.** Fifty years of jet in crossflow research. In: Proceedings of the AGARD symposium on computational and experimental assessment of jets in crossflow. AGARD-CP-534. London, United Kingdom: Advisory Group for Aerospace Research and Development: 1.1 through 1.41.
- Martin, R.E.; Pendleton, D.W.; Burgess, W. 1976.** Effect of fire whirlwind formation on solid fuel burning rates. *Fire Technology*. 12(1): 33–40.
- McDonough, J.M.; Loh, A. 2003.** Simulation of vorticity-buoyancy interactions in fire-whirl-like phenomena. In: Proceedings, American Society of Mechanical Engineers Heat Transfer Summer Conference. American Society of Mechanical Engineers: 195–201.
- McGratten, K.B.; Baum, H.R.; Rehm, R.G. 1996.** Numerical simulation of smoke plumes from large oil fires. *Atmospheric Environment*. 30: 4125–4136.
- McMahon, H.; Hester, D.; Palfery, J.G. 1971.** Vortex shedding from a turbulent jet in a cross-wind. *Journal of Fluid Mechanics*. 48: 73–80.
- McRae, D.J.; Flannigan, M.D. 1990.** Development of large vortices on prescribed fires. *Canadian Journal of Forest Research*. 20: 1878–1887.
- Meroney, R.N. 2003a.** Fire whirls and building aerodynamics. In: Proceedings of the 11<sup>th</sup> international conference on wind engineering. <http://www.engr.colostate.edu/~meroney/projects/MERFWB.pdf>. (May 16, 2011).
- Meroney, R.N. 2003b.** Fire whirls, fire tornados, and fire storms: physical and numerical modeling. In: Proceedings of PHYSMOD2003: International workshop on physical modeling of flow and dispersion phenomena. <http://www.engr.colostate.edu/~meroney/PapersPDF/CEP03-04-1.pdf>. (May 16, 2011).
- Moore, T. 2008.** Indians Fire accident prevention analysis. Vallejo, CA: U.S. Department of Agriculture, Forest Service, Pacific Southwest Region. 113 p.
- Morton, B.R. 1966.** Geophysical vortices. *Progress in Aerospace Sciences*. 7: 145–194.
- Moussa, Z.M.; Trischka, J.W.; Eskinazi, S. 1977.** The near field in the mixing of a round jet with a cross-flow. *Journal of Fluid Mechanics*. 80: 49–90.
- Musham, H.A. 1941.** The Great Chicago Fire. In: *Papers in Illinois History and Transactions for the Year 1940*. Springfield, IL: Illinois Historical Society: 69–189.
- Pirsko, A.R.; Sergius, L.M.; Hickerson, C.W. 1965.** Causes and behavior of a tornadic fire-whirlwind. Res. Note PSW-61. Berkeley, CA: U.S. Department of Agriculture, Forest Service, Pacific Southwest Forest and Range Experiment Station.
- Porteire, B.; Loraud, J.C.; Morvan, D.; Larini, M. 1999.** A numerical study of buoyant flow in cross-flow conditions. *International Journal of Wildland Fire*. 9: 101–108.
- Schaefer, V.J. 1957.** The relationship of jet streams to forest fires. *Journal of Forestry*. 55: 419–425.
- Scorer, R.S. 1968.** Air pollution. Oxford, United Kingdom: Pergamon Press. 151 p.
- Simard, A.J.; Haines, D.A.; Blank, R.W.; Frost, J.S. 1983.** The Mack Lake Fire. Gen. Tech. Rep. NC-83. St. Paul, MN: U.S. Department of Agriculture, Forest Service, North Central Forest Experiment Station. 36 p.
- Smith, M.C.; Haines, D.A.; Main, W.A. 1986.** Some characteristics of longitudinal vortices produced by line-source heating in a low-speed wind tunnel. *International Journal of Heat Mass Transfer*. 29: 59–68.
- Snegirev, A.Y.; Marsden, J.A.; Francis, J.; Makhviladze, G.M. 2004.** Numerical studies and experimental observations of whirling flames. *International Journal of Heat and Mass Transfer*. 47: 2523–2539.

- Soma, S.; Saito, K. 1988.** A study of fire whirl on mass fires using scaling models. In: Proceedings of the first international symposium on scale modeling. Tokyo: The Japan Society of Mechanical Engineers: 353.
- Soma, S.; Saito, K. 1991.** Reconstruction of fire whirls using scale models. *Combustion and Flame*. 86: 269–284.
- Tsang, G. 1970.** Laboratory study of two-dimensional starting plumes. *Atmospheric Environment*. 4: 519–544.
- Tsang, G. 1971.** Laboratory study of line thermals. *Atmospheric Environment*. 5: 445–471.
- Trelles, J.; McGrattan, K.B.; Baum, H.R. 1999.** Smoke transport by sheared winds. *Combustion Theory and Modeling*. 3: 323–341.
- Turner, J.S. 1960.** A comparison between buoyant vortex rings and vortex pairs. *Journal of Fluid Mechanics*. 7: 419–433.
- Umscheid, M.; Monteverdi, J.; Davies, J. 2006.** Photographs and analysis of an unusually large and long-lived firewhirl. *Severe Storms Meteorology*. 1: 1–13.
- U.S. Department of the Interior, Bureau of Land Management [BLM]. 2001.** Preliminary 72 hour briefing on Fish Fire deployment investigation. [http://www.wildfirelessons.net/documents/2001\\_Fish\\_Crk\\_72\\_hr.pdf](http://www.wildfirelessons.net/documents/2001_Fish_Crk_72_hr.pdf). (March 23, 2010).
- U.S. Department of the Interior, Bureau of Land Management [BLM]. 2006.** New York Peak Fire burnover, factual report. [http://www.wildfirelessons.net/documents/new\\_york\\_peak\\_factual\\_report\\_2006.pdf](http://www.wildfirelessons.net/documents/new_york_peak_factual_report_2006.pdf). (March 23, 2010).
- Wade, D.D.; Ward, D.E. 1973.** Analysis of the Air Force Bomb Range Fire. Res. Pap. SE-105. Asheville, NC: U.S. Department of Agriculture, Forest Service, Southeastern Forest Experiment Station. 38 p.
- Zhang, X.; Ghoniem, A.F. 1993.** A computational model for the rise and dispersion of wind-blown, buoyancy-driven plumes. I. Neutrally stratified atmosphere. *Atmospheric Environment*. 15: 2295–2311.
- Zhou, R.; Wu, Z.N. 2007.** Fire whirls due to surrounding flame sources and the influence of the rotation speed on flame height. *Journal of Fluid Mechanics*. 583: 313–345.

This page was intentionally left blank.

## Chapter 8: Crown Fire Dynamics in Conifer Forests

Martin E. Alexander and Miguel G. Cruz<sup>1</sup>

*As for big fires in the early history of the Forest Service, a young ranger made himself famous by answering the big question on an exam, “What would you do to control a crown fire?” with the one-liner, “Get out of the way and pray like hell for rain.”—Norman Maclean (1992)*

### Introduction

Three broad types of fire are commonly recognized in conifer-dominated forests on the basis of the fuel layer(s) through which they are spreading:

- Ground or subsurface fire
- Surface fire
- Crown fire

Ground or subsurface fires spread very slowly and with no visible flame. Heading surface fires can spread with the wind or upslope, and backing surface fires burn into the

wind (fig. 8-1 A) or downslope. A crown fire is dependent on a surface fire for both its initial emergence and continued existence. Thus, a crown fire advances through both the surface and tree canopy fuel layers with the surface and crown fire phases more or less linked together as a unit (fig. 8-1 B and C). The term “crowning,” therefore, refers to both the ascension into the crowns of trees and the spread from crown to crown.

From the perspective of containing or controlling wildfires or unplanned ignitions, the development and subsequent movement of a crown fire represents a highly significant event as a result of the sudden escalation in the rate of advance and the dramatic increase in flame size and thermal radiation as well as convective activity, including fire-induced vortices and, in turn, both short- to long-range spotting potential. As a consequence, crown fires are dangerous for firefighters to try to control directly by conventional means. Suppression actions and options

<sup>1</sup> **Martin E. Alexander**, Department of Renewable Resources and Alberta School of Forest Science and Management, University of Alberta, Edmonton, Alberta, Canada. **Miguel G. Cruz**, Bush Fire Dynamics and Applications, CSIRO Ecosystems Sciences–Climate Adaptation Flagship, Canberra, ACT 2601, Australia.

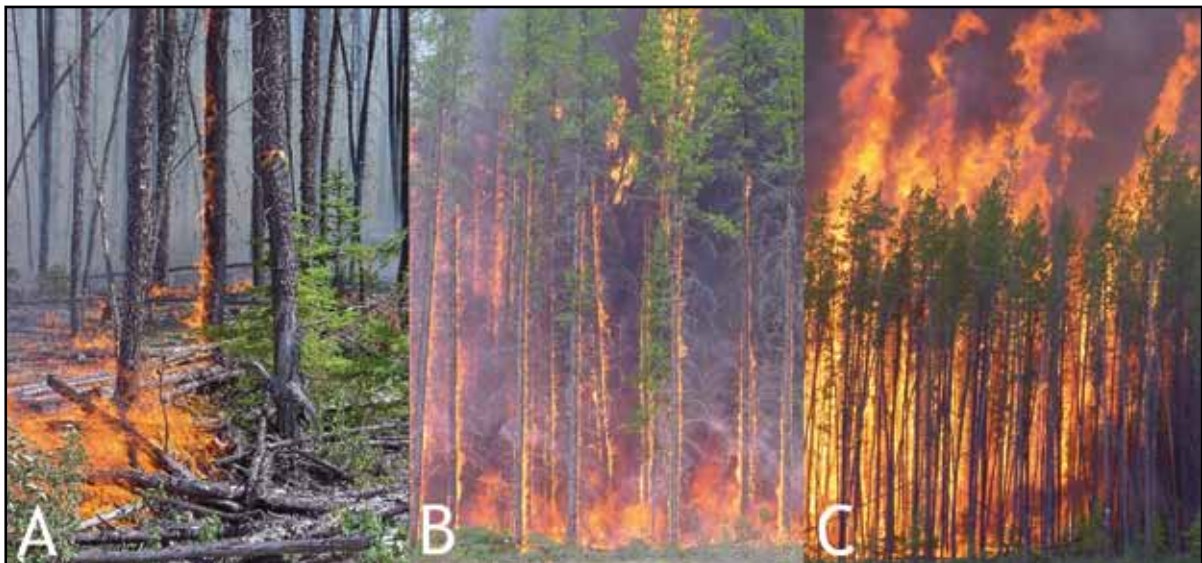

Figure 8-1—Variations in fire behavior within the jack pine/black spruce fuel complex found at the International Crown Fire Modeling Experiment study area near Fort Providence, Northwest Territories, Canada: (A) surface fire, (B) passive crown fire, and (C) active crown fire. For additional photography carried out on experimental basis, see Alexander and De Groot (1988), Alexander and Lanoville (1989), Stocks and Hartley (1995), and Hirsch et al. (2000).

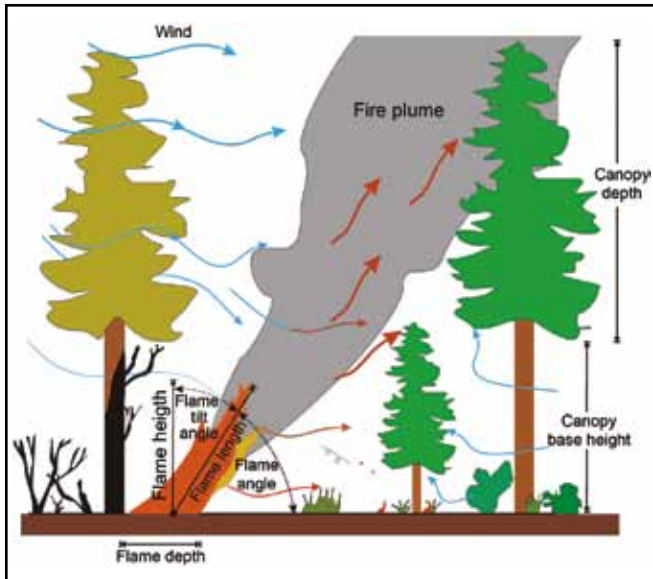

Figure 8-2—Cross section of a stylized, wind-driven surface head fire spreading behind a conifer forest canopy on level terrain.

at the head of the fire tend to be severely restricted until there is a major change in the prevailing fuel, weather, or topographic conditions (e.g., a drop in windspeed, a major fuel discontinuity). As a result, crown fires are capable of burning large tracts of forested landscape, thereby posing a threat to public safety and properties, potentially adversely impacting other values-at-risk, and increasing suppression expenditures.

Prolific crowning is an element or characteristic of extreme fire behavior in conifer-dominated forest cover types. This chapter constitutes a state-of-knowledge summary prepared for operational fire management personnel in the United States concerning our current understanding of the characteristics and prediction of crown fire behavior in such fuel complexes. Information on crown fire phenomenology is drawn upon from a number of sources, including relevant observations and data from Canada and Australia. The dynamics of crown fires in tall brush fields (e.g., chaparral) and other forest types (e.g., eucalypt) will not specifically be dealt with here. For present purposes, it is assumed that there is a distinct separation between the canopy fuel layer and the ground and surface fuels by an open trunk space in which ladder or bridge fuels may be

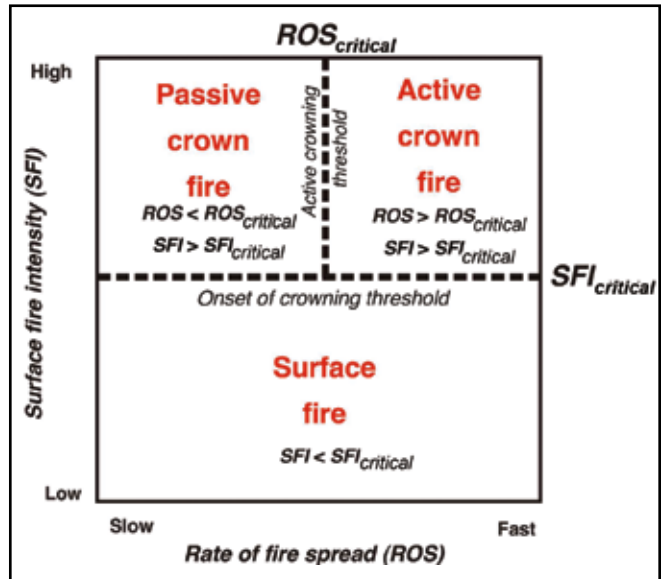

Figure 8-3—Type of fire classification scheme based on Van Wagner’s (1977a) theories regarding the start and spread of crown fires in conifer forests.

present (fig. 8-2). Certain aspects of crown fire behavior are not addressed here but can be found in other chapters of this synthesis document (e.g., horizontal roll vortices, plume- or convection-dominated crown fires, influences of atmospheric conditions aloft, fire-atmosphere interactions).

### Types of Crown Fires

Van Wagner (1977a) proposed that crown fires in conifer forests could be classified according to their degree of dependence on the surface fire phase and the criteria could be described by several semi-mathematical statements (fig. 8-3). He recognized three types of crown fires (box 1). According to Van Wagner (1977a), the type of crown fire to be expected in a conifer forest on any given day depends on three simple properties of the canopy fuel layer (box 2) and two basic fire behavior characteristics:

- Initial surface fire intensity
- Foliar moisture content
- Canopy base height
- Canopy bulk density
- Rate of fire spread after the onset of crown combustion



**Box 1:**

**Crown Fire Classification**

For the longest time, only two kinds of crown fire were generally recognized, namely “dependent” and “running” (Brown and Davis 1973). Van Wagner (1977a) recognized three classes or types of crown fires:

**Passive Crown Fire**

Passive or dependent crown fires can involve a portion or all of the canopy fuel layer in combustion, but the overall rate of spread is largely determined by the surface phase. Passive crown fires cover a range in fire behavior from moderately vigorous surface fires with frequent crown ignition occurring behind the surface flame front up to high-intensity surface fires spreading with an almost solid flame front occupying the canopy and subcanopy or trunk space that have nearly achieved the critical minimum spread rate for active crowning. Passive crown fires can occur under two broad situations. First, the canopy base height and canopy bulk density are considered optimum, but fuel moisture and wind conditions are not quite severe enough to induce full-fledged crowning (fig. 8-1 B). Second, the canopy base height and canopy bulk density are, respectively, above and below the thresholds generally

**Box 1: continued**

considered necessary for crowning (e.g., tall or open-forest stand types), so that even under severe burning conditions (i.e., critically dry fuels and strong surface winds), active crown fire spread is not possible, although vigorous, high-intensity fire behavior can occur.

**Active Crown Fire**

Active or running crown fires are characterized by the steady advancement of a tall and deep coherent flame front extending from the ground surface to above the top of the canopy fuel layer (fig. 8-1 C). The surface and crown phases are intimately linked, but fire propagation is largely determined by the crown phase. The spread of active crown fires requires (1) relatively dry and plentiful surface fuels that allow for the development of a substantial surface fire (2) low to moderately high canopy base height, and (3) a fairly continuous crown layer of moderate to high canopy bulk density ( $>0.1 \text{ kg/m}^3$ ) and low to normal foliar moisture content.

**Independent Crown Fire**

An independent crown fire no longer depends in any way on the surface phase, spreading ahead of the surface phase in the crown fuel layer entirely



**Box 1: continued**

on its own. Stand conditions favoring an independent crown fire are a continuous crown layer of low to moderate canopy bulk density and an abnormally low foliar moisture content. For a truly independent crown fire to develop on flat topography would require very strong, sustained winds. In mountainous terrain, slope steepness would no doubt compensate for a lesser velocity.

The vast majority of crowning forest fires spread either as passive or active crown fires, each controlled by a different set of processes. Van Wagner (1993) acknowledged that the concept of a truly independent crown fire as a stable phenomenon on level terrain is dubious but that it “may still have value in rough or steep terrain and as a short-term fluctuation under the most extreme conditions.” Indeed, there are reports of the flames in the crown extending 50 to 150 m ahead of the surface burning in momentary bursts and of crown fires spreading up steep, partially snow-covered slopes in the spring (Mottus and Pengelly 2004). These incidents might possibly give the appearance of being evidence for independent crown fires. However, there is no steady-state propagation

**Box 1: continued**

as seen with passive and active crown fires.

It is worthwhile noting that the concept of passive crowning implies an element of forward movement or propagation of the flame front. The incidental ignition of an isolated tree or clump of trees, with the flames spreading vertically from the ground surface through the crown(s) without any form of forward spread following, does not constitute passive crowning. Flame defoliation of conifer trees by what amounts to stationary torching or “crowning out,” especially common during the postfrontal combustion stage following passage of the surface fire, generally does not generate any kind of horizontal spread.

Scott and Reinhardt (2001) claimed that the possibility exists for a stand to support an active crown fire that would otherwise not initiate a crown fire. They referred to this situation as a “conditional surface fire.” Later on Scott (2006) termed this a “conditional crown fire.” To our knowledge, no empirical proof has been produced to date to substantiate the possible existence of such a situation, at least as a steady-state phenomenon.

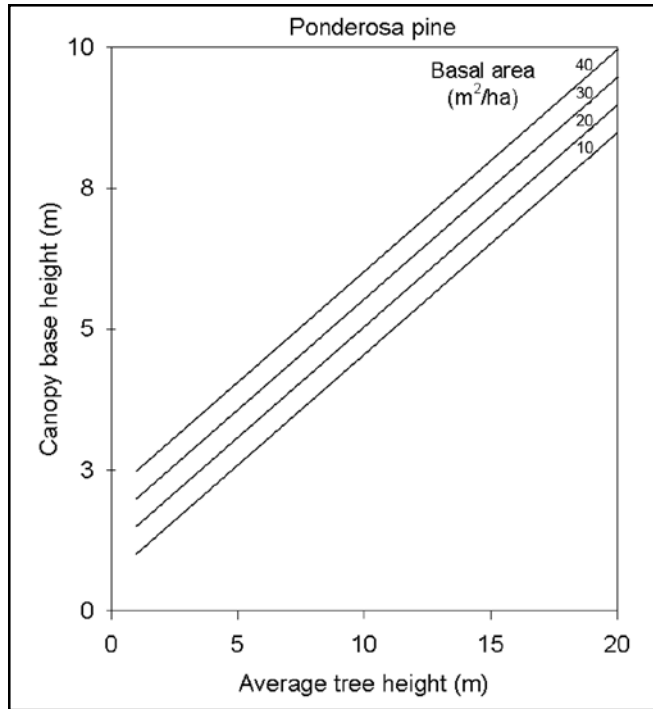

Figure 8-4—Canopy base height for ponderosa pine stands as a function of average stand height and basal area according to Cruz et al. (2003a). The regression equation used to produce this graph is not valid for tree heights of less than 1.0 m.

The first three quantities determine whether a surface fire will ignite coniferous foliage. The last two determine whether or not a continuous flame front can be sustained in the canopy fuel layer. The initial surface fire intensity and rate of fire spread after the onset of crown combustion would, in turn, include the effects of windspeed, slope steepness, fuel dryness, air temperature, relative humidity, and fuel complex characteristics. Examples of how canopy base height and canopy bulk density CBD vary with tree and stand characteristics is presented here for ponderosa pine in figures 8-4 and 8-5.

Albini and Stocks (1986) considered the factors included in Wagner’s (1977a) proposed criteria for the start and spread of a crown fire as “heuristically valid.” Subsequent experience and analysis has shown both the strengths and limitations of his approach (Cruz et al. 2003c, 2004, 2006a).

### Crown Fire Initiation

For a crown fire to start, an intense surface fire is generally required. The questions then become: How do we define fire

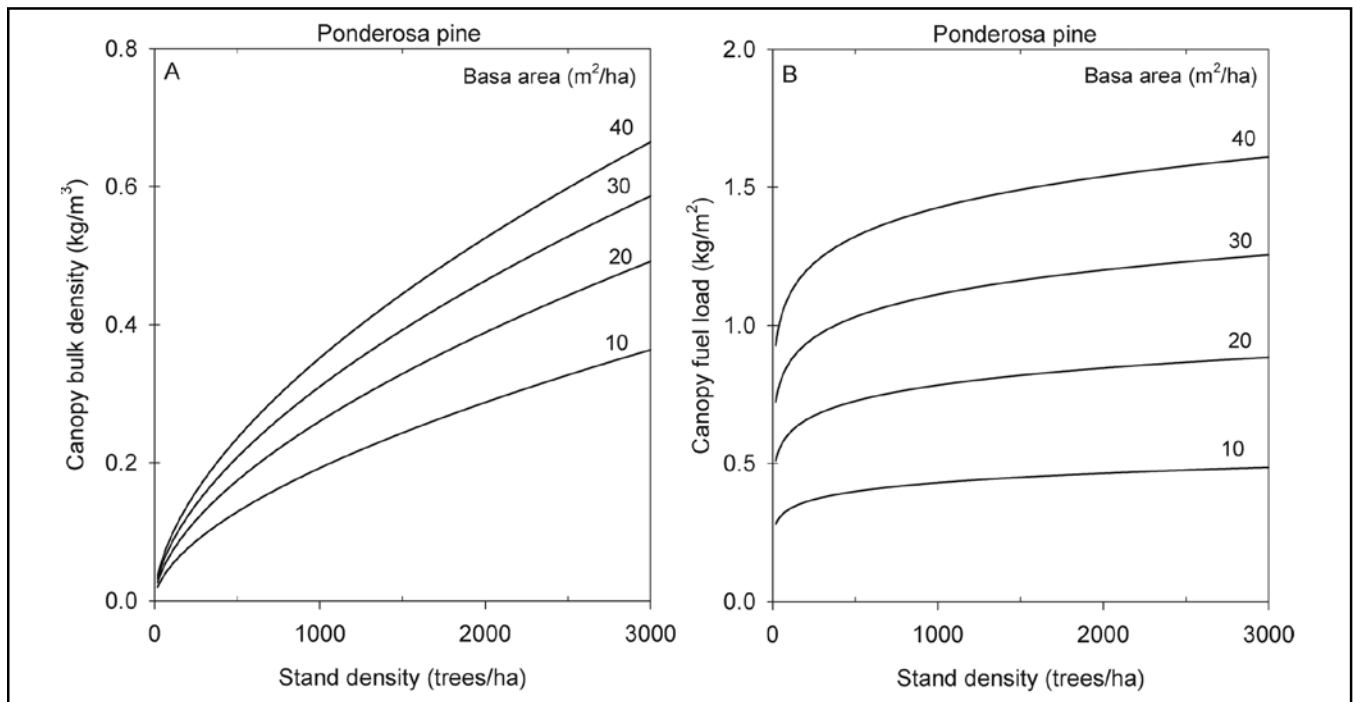

Figure 8-5—Canopy bulk density (A) and canopy fuel load (B) for ponderosa pine stands as a function of stand density and basal area according to Cruz et al. (2003a).

**Box 2:****Canopy Fuel Characteristics in Van Wagner's (1977a) Crown Fire Initiation and Propagation Models****Canopy Base Height**

Canopy base height (CBH) represents the mean height from the ground surface to the lower live crown base of the conifer trees in a forest stand (fig. 8-2). Canopy base height is dependent on the mean tree height and live stem density (fig. 8-4). Ladder or bridge fuels (e.g., loose bark and dead bole branches on tree boles, lichens, shrubs, and small conifers) in the space between the ground surface and the canopy “must presumably be present in sufficient quantity to intensify the surface fire appreciably as well as to extend the flame height” (Van Wagner 1977a). Unfortunately, our ability to assess ladder or bridge fuel effects on crown fire initiation remains qualitative (Menning and Stephens 2007).

**Canopy Bulk Density**

Canopy bulk density (CBD) represents the amount of available crown fuel within a unit volume of the canopy. Canopy bulk density is computed by dividing the canopy fuel load (CFL) by the canopy depth (fig. 8-2), which represents the average tree height of the stand minus the CBH. The CFL

**Box 2: continued**

represents the quantity of crown fuel typically consumed in a crown fire, principally needle foliage. Both the CBD and CFL are, in turn, functions of stand structure characteristics (fig. 8-5).

**Foliar Moisture Content**

Foliar moisture content (FMC) represents a weighted average or composite moisture content for the various needle ages found within the canopy fuel layer. Needles decrease in moisture content with age following their initial flushing (Keyes 2006).

Some researchers such as Scott and Reinhardt (2001) have applied different criteria to the CBH, CFL, and CBD inputs in their use of Van Wagner's (1977a) models (Cruz and Alexander 2010, in press). However, strictly speaking, such ad hoc adjustments or modifications are not compatible with the use of these models. Still others have in some cases recommended or applied potentially unrealistically low values of FMC (Cruz and Alexander 2010). Varner and Keyes (2009) have outlined other faulty assumptions and common errors regarding modeling inputs involved in simulating fire behavior potential.

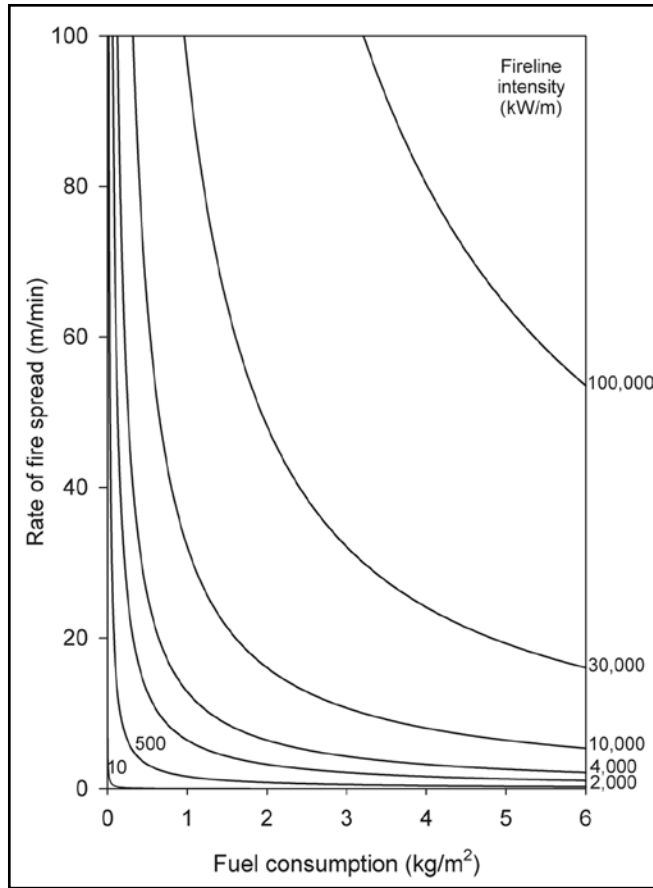

Figure 8-6—Head fire rate of spread and fuel consumed in relation to the type of fire and six distinct levels of Byram’s (1959a) fireline intensity, assuming a net heat of combustion of 18 000 kJ/kg.

intensity? and How intense is intense enough with respect to the convective and radiative energy transferred upward to the canopy fuels necessary to initiate crowning? The distance the canopy fuel layer (fig. 8-4) is from the heat source at the ground surface will dictate how much energy is dissipated before reaching the fuels at the base of the canopy. Furthermore, if the moisture content of the canopy fuels is high, greater amounts of energy are required to raise the tree foliage to ignition temperature.

Byram (1959a) defined fireline intensity ( $I$ , kW/m) as the rate of heat released from a linear segment of the fire perimeter as calculated by the following equation:

$$I = H \times w \times r \quad (1)$$

where  $H$  is regarded as the net low heat of combustion (kJ/kg),  $w$  is amount of fuel consumed in the active flaming

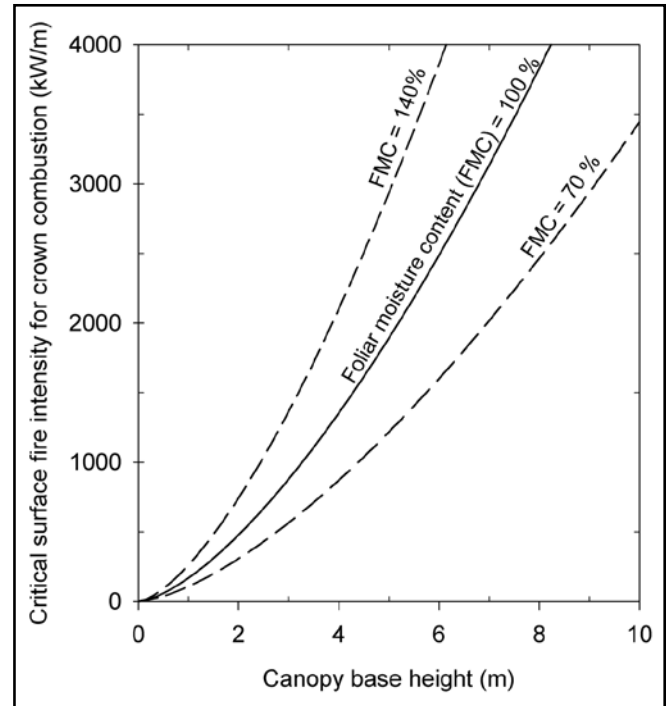

Figure 8-7—Critical surface fire intensity for crown combustion in a conifer forest stand as a function of canopy base height and foliar moisture content according to Van Wagner (1977a).

front ( $\text{kg/m}^2$ ), and  $r$  is the rate of fire spread (m/s) (Alexander 1982). If we assume  $H = 18\,000$  kJ/kg, then the equation for calculating fireline intensity can also be expressed as follows:

$$I = 300 \times w \times ROS \quad (2)$$

where  $ROS$  is the rate of fire spread given in m/min. A graphical representation of this relation is presented in figure 8-6. Wendel et al. (1962) concluded that the probability of blowup fires decreased rapidly when available fuel loads were less than  $1.35 \text{ kg/m}^2$ .

Using physical reasoning and empirical observation, Van Wagner (1977a) proposed that vertical fire spread could occur in a conifer forest stand when the surface fire intensity ( $SFI$ ) attains or exceeds a certain critical surface intensity for combustion ( $SFI_{critical}$ , kW/m) as dictated by the foliar moisture content ( $FMC$ , %) and the canopy base height ( $CBH$ , m) according to the following equation which is graphically presented in figure 8-7:

$$SFI_{critical} = (0.01 \times CBH \times (460 + 25.9 \times FMC))^{1.5} \quad (3)$$

**Table 8-1—Fire suppression interpretations of flame length and fireline intensity**

Flame length <sup>a</sup>	Fireline intensity	Fire suppression interpretations
Meters	kW/m	
<1.2	<346	Fire can generally be attacked at the head or flanks by persons using hand tools. Handline should hold the fire.
1.2 to 2.4	346 to 1730	Fires are too intense for direct attack on the head by persons using hand tools. Handline can not be relied on to hold fire. Equipment such as plows, dozers, pumpers, and retardant aircraft can be effective.
2.4 to 3.4	1730 to 3459	Fires may present serious control problems: torching out, crowning, and spotting. Control efforts at the fire head will probably be ineffective.
>3.4	>3459	Crowning, spotting, and major fire runs are probable. Control efforts at head of fire are ineffective.

<sup>a</sup> Based on Byram’s (1959a) flame length (*L*, m)-fireline intensity (*I*, kW/m) relation:  $L = 0.0775 \times (I)^{0.46}$ .

Adapted from Burgan 1979.

Thus, according to Van Wagner’s (1977a) theory of crown fire initiation, if  $SFI > SFI_{critical}$ , some form of crowning is presumed to be possible, but if  $SFI < SFI_{critical}$ , a surface fire is expected to prevail (fig. 8-3). In applying this criterion, it is assumed that a conifer forest stand possesses a minimum CBD that will allow flames to propagate vertically through the canopy fuel layer.

One of the appealing aspects of eq. (3) is its simplicity, but with this comes a major underlying assumption. According to Van Wagner (1977a), the 0.01 value given in eq. (3) is an empirical constant of “complex dimensions.” He derived this value from an outdoor experimental fire in a red pine plantation stand (see “Common and Scientific Names” section) with *CBH* of 6.0 m and a *FMC* of 100 percent and the *SFI* was about 2500 kW/m just prior to crowning (Van Wagner 1968). This widely used relation represented by eq. (3) therefore incorporates a fixed set of burning conditions, fuel characteristics, and surface fire behavior (e.g., in-stand wind, ladder fuels, fuel consumed, flame depth, and spread rate). Subsequent research has shown this empirical constant to be a variable quantity dependent on these factors (Alexander 1998, Cruz et al. 2006a).

From figure 8-7, it should be clear that the higher the *CBH* and/or *FMC*, the more intense a surface fire must

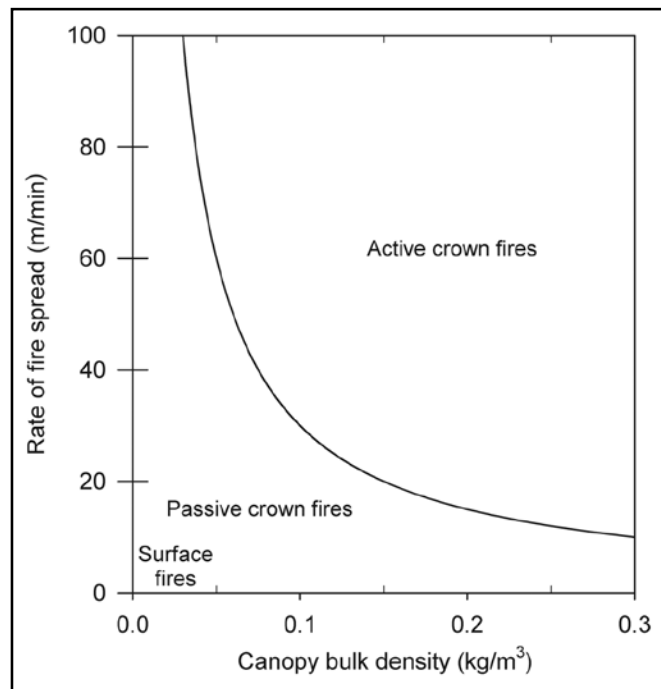

Figure 8-8—Critical minimum spread rate for active crowning in a conifer forest stand as a function of canopy bulk density according to Van Wagner (1977a).

be to cause crowning. It is worth noting that the flames of a surface fire don’t necessarily have to reach or extend into the lower tree crowns to initiate crowning (Alexander 1988). The experimental fire used by Van Wagner (1977a) to

parameterize his crown fire initiation model represented by eq. (3) would, for example, have had a flame length of 2.6 m according to Byram's (1959a) formula linking flame length to fireline intensity (table 8-1).

## Crown Fire Propagation

Assuming a surface fire is of sufficient intensity to initiate and sustain crown combustion from below, the question now becomes, Can a solid flame front develop and maintain itself within the canopy fuel layer in order for horizontal crown fire spread to occur? Van Wagner (1977a) theorized that a minimum flow of fuel into the flaming zone of a crown fire is required for combustion of the canopy fuel layer to continue. In this conceptual formulation, the flame front is viewed as stationary with the fuel moving into it.

Van Wagner (1977a) proposed that a critical minimum spread rate needed to preserve continuous crowning ( $ROS_{critical}$ , m/min) could be estimated on the basis of the stand's canopy bulk density (CBD,  $\text{kg/m}^3$ ) using the following simplistic equation:

$$ROS_{critical} = 3.0 \div CBD \quad (4)$$

According to eq. (4),  $ROS_{critical}$  increases as the CBD decreases (fig. 8-8). High CBD levels are associated with dense stands and low values with open stands (fig. 8-5). Active crowning is presumably not possible if a fire does not spread rapidly enough following initial crown combustion. Albin (1993) viewed this criterion for active crowning as a "lean flammability limit." Thus, if a fire's actual ROS after the initial onset of crowning, which is in turn a function largely of the prevailing windspeed or slope, is less than  $ROS_{critical}$ , a passive crown fire is expected to occur (fig. 8-3).

The 3.0 empirical constant given in eq. (4) was derived largely on the basis of a single experimental crown fire in a red pine plantation stand exhibiting a CBD of  $0.23 \text{ kg/m}^3$  (Van Wagner 1964). However, the robustness of this value has since been confirmed on the basis of an analysis of a relatively large data set of experimental crown fires in several different conifer forest fuel complexes (Cruz et al. 2005) and a detailed wildfire behavior case study

(Alexander 1998). These analyses also support Agee's (1996) assertion that a CBD of about  $0.1 \text{ kg/m}^3$  constitutes a significant threshold for active crown fires. Furthermore, it appears from the function represented by eq. (4) and the available empirical evidence (fig. 8-8), that active crown fires are unlikely to occur at CBD levels below about  $0.05 \text{ kg/m}^3$ , although this is not to suggest that a very vigorous, high-intensity passive crowning is not possible.

## Crown Fire Rate of Spread

Surface fires spreading beneath conifer forest canopies seldom exceed 5 to 10 m/min without the onset of crowning in some form or another (fig. 8-6). The exceptions would involve open stands with a low CBD (say less than  $0.05 \text{ kg/m}^3$ ) or closed-canopied stands exhibiting a very high canopy base height (perhaps 12 to 15 m or greater), in which case, spread rates might reach as high as 25 m/min with associated fireline intensities of 10 000 kW/m.

General observations of wildfires and documentation of experimental crown fires indicate that a rather abrupt transition between surface and crown fire spread regimes is far more commonplace than a gradual transition (Van Wagner 1964). With the onset of crowning, at a minimum, a fire typically doubles or even triples its spread rate in comparison to its previous state on the ground surface (McArthur 1965). This sudden jump in the fire's rate of spread occurs as a result of (i) the enhanced radiant heating owing to the taller and deeper flame fronts, (ii) the fact that the windspeeds just above the tree canopy are two and one-half to six times that of the winds experienced near ground level inside the stand, (iii) increased efficiency of heat transfer into a tall and porous fuel layer, and (iv) an increase in spotting density and distance just beyond the fire's leading edge.

Once crowning has commenced, a fire's forward rate of spread on level terrain is influenced largely by wind velocity and to a lesser extent by physical fuel properties and dryness. Continuous crowning generally takes place at spread rates between about 15 and 45 m/min. Crowning wildfires have been known to make major runs of 30 to 65 km over flat and rolling to gently undulating ground



during a single burning period or over multiple days, as so vividly demonstrated, for example, on the Rodeo-Chediski Fire in northern Arizona in June 2002 (Paxton 2007). A wildfire crowning through sand pine forests in north-central Florida on March 12, 1935, travelled nearly 32 km in about 6 hours with intervening spread rates of 135 to 150 m/min (Folweiler 1937). During the major run of the Mack Lake Fire in Michigan that occurred on May 5, 1980, the crown fire rate of spread in jack pine forests peaked at nearly 190 m/min during a 15-min interval (Simard et al. 1983). Grass fires have been reported to spread at twice these rates on level ground and are thus capable of spreading the same distance as crowning forest fires in half the time (Cheney and Sullivan 2008).

In some conifer forest fuel types exhibiting discontinuous or very low quantities of surface fuels, surface fire spread is nearly nonexistent, even under moderately strong winds. However, once a certain windspeed threshold is reached with respect to a given level of fuel dryness, a dramatic change to crown fire spread suddenly occurs. This type of fire behavior has been observed in pinyon-juniper woodlands of the Western United States (Bruner and Klebenow 1979) and in the sand pine forests of Florida (Hough 1973), for example. The same phenomenon has been observed in certain grassland and shrubland fuel complexes (Cheney and Sullivan 2008, Lindenmuth and Davis 1973).

Slope dramatically increases the rate of spread and intensity of wildland fires by exposing the fuel ahead of the advancing flame front to additional convective and radiant heat. Fires advancing upslope are thus capable of making exceedingly fast runs compared to level topography. For example, one would expect a crown fire burning on a 35-percent slope to spread about 2.5 times as fast as one on level terrain for the same fuel and weather fuel conditions (Van Wagner 1977b). As slope steepness increases, the flames tend to lean more and more toward the slope surface, gradually becoming attached, the result being a sheet of flame moving roughly parallel to the slope. Rothermel (1985) has stated that although there is no definitive research on the subject of flame attachment, “it appears from lab work and discussions with users that the flames

become attached near 50 percent slope with no prevailing wind.” The critical value will actually differ depending on the prevailing wind strength (Cheney and Sullivan 2008) as well as on the fuel type characteristics. The time-lapse photography taken of the rapid upslope runs on the 1979 Ship Island Fire in central Idaho as shown in the video *Look Up, Look Down, Look Around* (National Wildfire Coordinating Group 1993) constitutes a good example of such fire behavior.

With the exception of very long slopes such as found, for example, in the Salmon River country of central Idaho, the rate of advance of wind-driven crown fires in mountainous terrain tends, over the duration of their run, to be well below what would be expected on flat ground, even under critical fire weather conditions. This is a result of the degree of terrain exposure to the prevailing winds, which limits the full effectiveness of windspeed on fire spread, as well as differences in fuel moisture owing to aspect (Schroeder and Buck 1970). However, when the advancing crown fire front encounters a situation where wind and topography result in a favourable alignment, spread rates of ~100 m/min are quite easily possible for a brief period over short distances with only moderately strong winds (e.g., Rothermel and Mutch 1986). Fire spread rates in grassland and shrubland fuel types at even twice this level can easily occur (Butler et al. 1998, Rothermel 1993).

It is worth highlighting the fact that crown fire runs in mountainous terrain are not limited to just upslope situations. Cases of crown fires burning downslope or cross-slope under the influence of strong winds have occurred in the past (Byram 1954, McAlpine et al. 1991). The major run of the Dude Fire in northern Arizona on June 26, 1990, that led to the deaths of six firefighters involved downslope and cross-slope spread as a result of the strong downdraft winds caused by the fire’s collapsing convection column (Goens and Andrews 1998).

### **Crown Fire Intensity and Flame Zone Characteristics**

When a conifer forest stand crowns, additional fuel is consumed primarily in the form of needle foliage but also

mosses and lichens, bark flakes, and small woody twigs. The additional fuel consumed by a crown fire owing to the canopy fuel involvement generally amounts to 0.5 to 2.0 kg/m<sup>2</sup> depending on stand characteristics (i.e., an increase in fuel consumption with respect to fireline intensity of one-quarter to a doubling in the amount). Combined with the increase in rate of fire spread after crowning, fireline intensities can easily quadruple in value within a few seconds (e.g., from 3000 kW/m to 12 000 kW/m). In such cases, is there any wonder why some fires seem to literally “blow up”?

A fire’s flame zone characteristics (i.e., depth, angle, height, and length) are a reflection of its heat or energy release rate. As the fireline intensity or rate of energy released per unit area of the flame front increases because of a faster rate of spread and a larger quantity of fuel being volatilized in the flaming front, flame size or volume increases. Fireline intensities of wind-driven crown fires can exceed 100 000 kW/m for significant periods (Anderson 1968, Kiil and Grigel 1969).

The flame depth ( $D$ , m) of a spreading wildland fire (fig. 8-2) is a product of its *ROS* and the flame front residence time ( $t_r$ , min) which represents the duration that a moving band or zone of continuous flaming combustion persists at or resides over a given location:

$$D = ROS \times t_r \quad (5)$$

Residence times are dictated largely by the particle size(s) distribution, load, and compactness of the fuelbed. Residence times for conifer forest fuel types at the ground surface are commonly 30 sec to 1 min compared to 5 to 10 sec in fully cured grass fuels. Assuming  $t_r = 0.75$  min (i.e., 45 sec), a surface fire in a conifer forest spreading at 4.0 m/min would thus have flame depth of around 3.0 m according to eq. (5). Crown fires are capable of producing very deep flame fronts. The depth of the burning zone in the surface fuels of a crown fire spreading at 60 m/min would, for example, be around 45 m. The flame depth of a grass fire advancing at this rate would in contrast be only about a tenth of this value. Residence times within the canopy fuel layer of a crown fire are approximately one-half to one-third

those experienced at ground level (Anderson 1968, Taylor et al. 2004). This is reflected in the gradual convergence of the flaming zone depth with height ending in the flame tip above the tree crowns.

The flame front of a crown fire on level ground appears to be roughly vertical or nearly so. This appearance has led to the popular phrase “wall of flame” when it comes to describing crown fire behavior. Typically though, tilt angles are 5 to 20 degrees from the vertical. The fact that the flames of a crown fire stand so erect is a direct result of the powerful buoyancy associated with the large amount of energy released in the flame front (fig. 8-1 C). Radiation from the crown fire wall of flame can produce painful burns on exposed skin at more than 100 m from the fire edge (Albini 1984).

Given the difficulty of gauging the horizontal depth of the burning zone in a crown fire, flame height constitutes a more easily visualized dimension than flame length. However, efforts to objectively estimate flame heights of crown fires is complicated by the fact that sudden ignition of unburned gases in the convection column can result in flame flashes that momentarily extend some 100 m or more into the convection column aloft; one such flame flash was photographically documented that extended almost 200 m above the ground (Sutton 1984). Such flashes can easily result in overestimates of average flame heights, which usually range from about 15 to 45 m on high-intensity crown fires (Byram 1959b). Average flame heights of crown fires are thus generally regarded as being about two (fig. 8-1 C) to three times the stand height.

## Crown Fire Area and Perimeter Growth

For forest fires of today to become large, they typically have to involve some degree of crowning. A common axiom is that 95 percent of area burned is generally caused by less than 5 percent of the fires. When a forest fire at the very minimum doubles its spread rate after the onset of crowning, the area burned for a given period will be at least four times what would have been covered by a surface fire. In other words, the area burned is proportional to the rate of

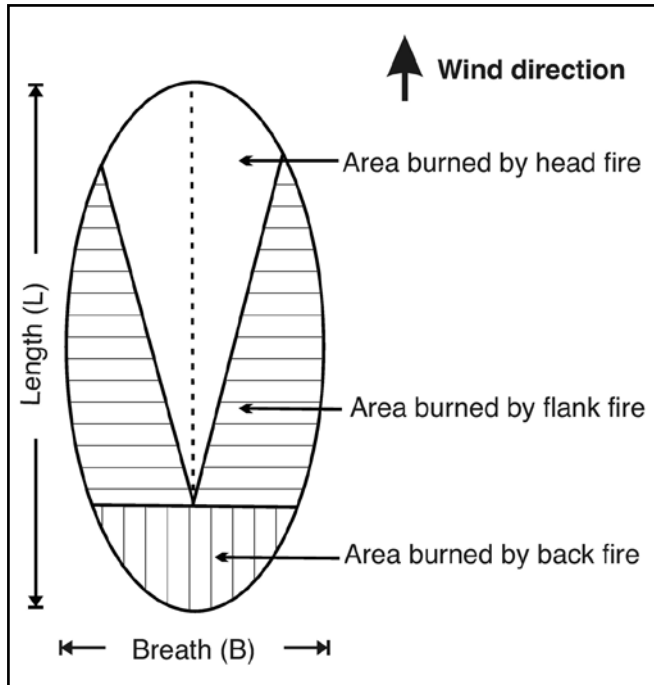

Figure 8-9—Schematic diagram of a simple elliptical fire growth model (after Van Wagner 1969). The point of ignition is at the junction of the four area growth zones.

spread increase (following the transition to crowning) to a power of 2.0 (McArthur 1965). Thus, if a fire triples its rate of advance after crowning, the area burned will be nine times the size it would have been had it remained as a surface fire (i.e.,  $3.0^2 = 9$ ).

Other than dry and plentiful fuels, the principal ingredients for major crown fire runs are strong, sustained winds coupled with extended horizontal fuel continuity. The Hayman Fire that occurred along the Colorado Front Range, for example, burned close to 25 000 ha during its major run on June 9, 2002, and eventually grew to nearly 56 000 ha towards the end of the month (Graham 2003). Under favourable conditions, crown fires on level to gently undulating terrain have been documented to cover in excess of 70 000 ha in a single, 10-hour burning period (Kiil and Grigel 1969) and up to a third that much in mountainous areas (Anderson 1968).

Assuming continuous fuels, including no major barriers to fire spread, and no change in wind and fuel moisture conditions, the forward spread distance of a crown fire can

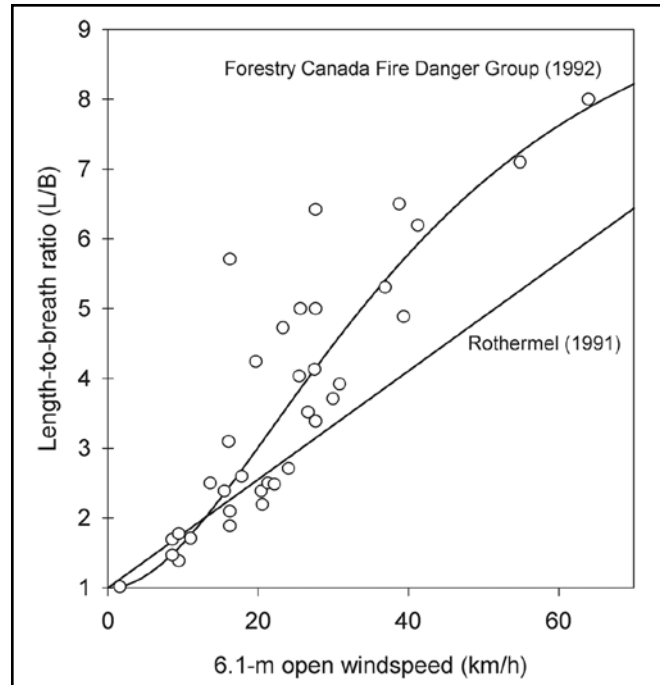

Figure 8-10—Length-to-breadth ratio of elliptical-shaped fires on level terrain as a function of windspeed, as used in the Canadian Forest Fire Behavior Prediction System (Forestry Canada Fire Danger Group 1992) and in Rothermel's (1991) guide to crown fire behavior in relation to experimental fire and wildfire observations given in Alexander (1985) and Forestry Canada Fire Danger Group (1992). The Beaufort scale for estimating 6.1-m open windspeeds is presented in table 8-4.

be determined by multiplying its predicted rate of spread by a projected elapsed time. Provided the wind direction remains relatively constant and the fire environment is otherwise uniform, wind-driven surface and crown fires typically assume a roughly elliptical shape (Alexander 1985, Anderson 1983, Van Wagner 1969) defined by its length-to-breadth ratio (L:B) (fig. 8-9), which in turn is a function of windspeed (fig. 8-10). The L:B associated with crown fires generally ranges from a little less than 2.0 to a maximum of approximately 8.0 in exceptional cases (Folweiler 1937). Simple estimates of potential crown fire size in terms of area burned and perimeter length can be made on the basis of the forward spread distance and L:B (fig. 8-11).

This simplistic picture of fire growth as described here is applicable to cases involving a point source ignition (e.g., an escaped campfire or lightning fire start) or perhaps

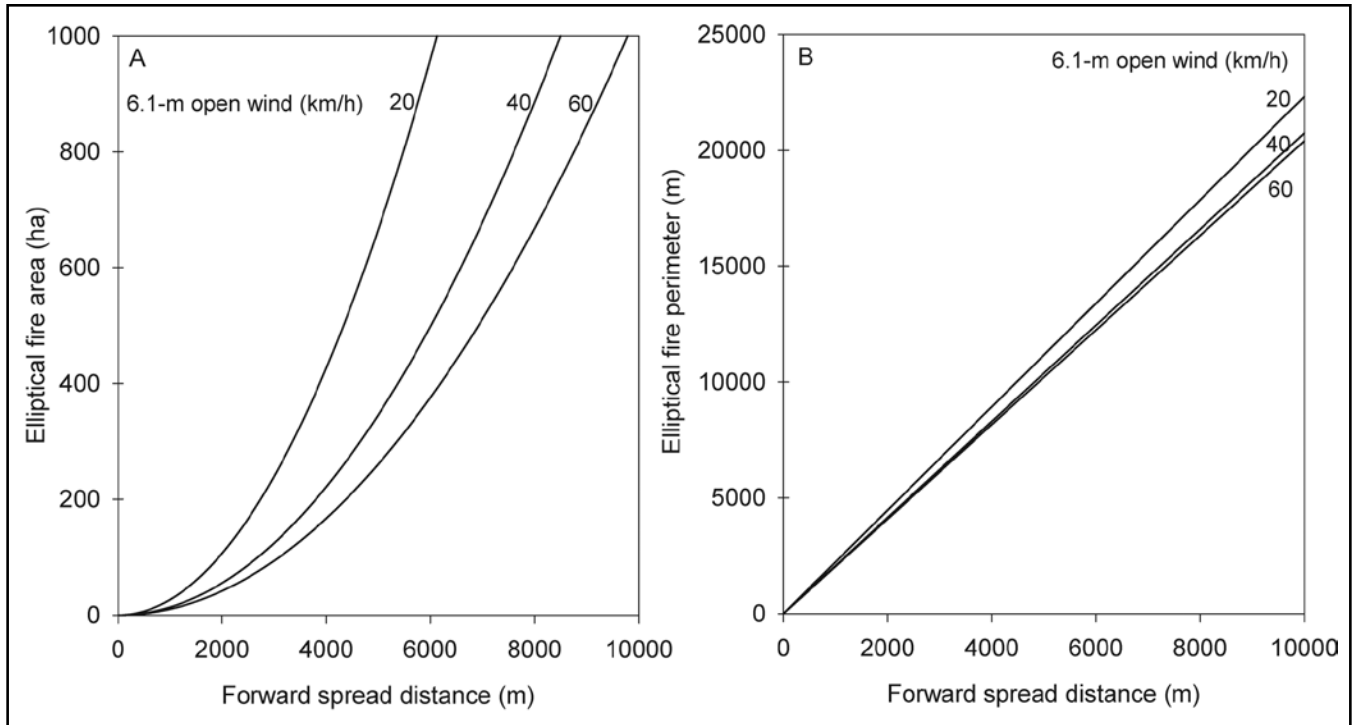

Figure 8-11—Area burned (A) and perimeter length (B) of an elliptical-shaped crown fire as a function of forward spread distance and windspeed on level terrain. The Beaufort scale for estimating 6.1-m open windspeeds is presented in table 8-4.

a breach in an established control line, involving unidirectional winds and is generally limited to a 1- to 8-hour projection period. This approach is thus not appropriate to estimating crown fire growth when the perimeter becomes highly irregular in shape with the passage of time as a result of changes in wind direction, fuel types, and terrain characteristics (e.g., Rothermel et al. 1994).

One particularly dangerous synoptic fire weather situation worth highlighting with respect to crown fire behavior is the case of the dry cold frontal passage (Schroeder and Buck 1970). In the Northern Hemisphere, winds ahead of an approaching dry cold front generally shift from the southeast to south, and finally to the southwest. As the cold front passes over an area, winds shift rapidly to the west, then northwest. Windspeeds increase in strength as a front approaches, and usually become quite strong and gusty when the front passes over an area. This can result in a long crown fire run in a north-northeast direction followed by a

fire's entire right flank crowning in an east-southeast direction at an even greater rate of spread and intensity (DeCoste et al. 1968, Simard et al. 1983, Wade and Ward 1973).

### Crown Fire Spotting Activity

Spotting or mass ember transport can be an important mechanism determining a crown fire's overall rate of spread under certain conditions. Its general effect on crown fire rate of spread is determined by the density of ignitions and distances these ignitions occur ahead of the main fire. These two characteristics are intimately linked, with density typically decreasing with distance from the main advancing flame front.

The effect of spotting on the overall spread and growth of a wildland fire is dependent on topography and fuel distribution. In certain fuel types, the propagation of active crown fires is linked to high-density, short-range spot fires occurring up to 50 m or so ahead of the main advancing flame front followed by their subsequent coalescence.

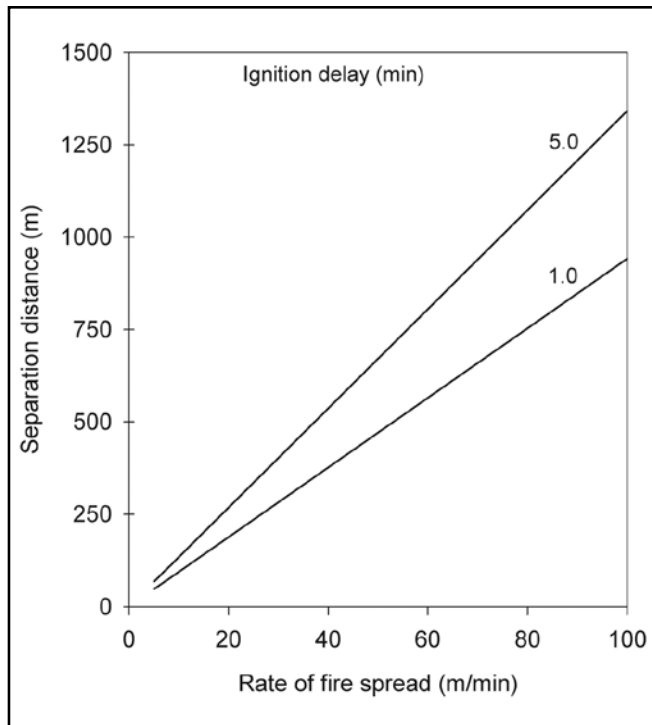

Figure 8-12—Minimum separation distance required for a newly ignited spot fire to avoid being overrun by the main flame front of an advancing crown fire as a function of rate of spread and ignition delay (adapted from Alexander and Cruz 2006). Ignition delay represents the elapsed time between a firebrand alighting, subsequent ignition, and the onset of fire spread.

Under such conditions, the overall fire spread is dictated by spotting as well as radiative and convective heat transfer mechanisms associated with the crowning phase (Taylor et al. 2004). In situations involving heterogeneous fuel type distributions and complex topography, spotting will allow the main advancing fire front to quickly bypass areas with low spread potential (e.g., downslope runs, pure hardwood stands in summer, discontinuous fuels) thereby effectively advancing the horizontal extent of the fire’s “head.” Spotting from crown fires is also effective in breaching major barriers to fire spread, including large water bodies and other nonfuel areas (e.g., rock slides, barren ground).

When fire environment conditions are uniform and winds aloft are favorable, spotting can contribute to the overall spread and growth of crown fires provided the spot fires are able to burn independently of the main advancing fire front. In most high-intensity wildfires that involve

crowning, spot fires originating out ahead of the advancing flame front are typically overrun and thus incorporated into the larger fire perimeter before they are able to develop and spread independently, or otherwise be influenced by the main fire (e.g., in-draft winds). For a crown fire spreading at a rate of 50 m/min or 3 km/h and burning under homogeneous fuel, weather, and topographic conditions, spotting distances would, depending on the ignition delay, have to exceed approximately 500 to 700 m (fig. 8-12) to have the potential to increase a fire’s overall rate of spread through a “leapfrog” type of effect. If there are sufficient spot fires at or just beyond this distance that can rapidly coalesce, this “mass ignition” effect will temporarily lead to the formation of pseudo flame fronts with greatly increased flame heights (Wade and Ward 1973).

Spotting distances of up to about 2 km are commonly observed on wind-driven crown fires in conifer forests, but spotting distances close to 5 km have been documented as well. Spot fire distances of 6 to 10 km were reported to have occurred in the Northern Rocky Mountains during the 1910 and 1934 fire seasons. The occurrence of spotting distances greater than 5 km require a specific combination of convection column strength and vertical wind profile. For a viable firebrand to travel such distances, a large amount of energy needs to be released (associated with the postfrontal combustion of large fuels) to transport the firebrands at significant heights. Spotting distances of this magnitude are likely to be associated with isolated peaks of fire intensity, such as those occurring in an upslope run, that will inject large quantities of firebrands in the plume. An atmospheric profile with very strong winds aloft is also necessary to considerably tilt the convection column and allow for significant drift of the firebrand after it leaves the plume. Under exceptional circumstances, spotting distances greater than 10 km have been described. Especially noteworthy is the 16- to 19-km spot fire distances associated with the 1967 Sundance Fire in northern Idaho (Anderson 1968), which were quite possibly caused by massive fire-induced vortices.

**Table 8-2—Predicted fine dead fuel moisture content (FDFM) as a function of ambient air temperature and relative humidity assuming >50-percent shading between 1200–1600 hours during May–July**

Relative humidity	Air temperature				
	0 – 9	10 – 20	21 – 31	32 – 42	>43
<i>Percent</i>	<i>Degrees Celsius</i>				
0–4	4	4	4	4	4
5–9	5	5	4	4	4
10–14	5	5	5	5	5
15–19	6	6	5	5	5
20–24	7	7	6	6	6
25–29	8	8	7	7	7
30–34	8	8	8	7	7
35–39	9	9	8	8	8
40–44	10	9	9	9	9
45–49	10	10	10	10	10
50–54	10	10	10	10	10
55–59	11	11	11	11	11
60–64	12	11	11	11	11
65–69	12	12	11	11	11
70–74	13	12	12	12	12
75–79	14	13	13	13	13

The FDFM values are used in the Rothermel (1991) crown fire rate of spread model and in the Cruz et al. (2004, 2005) models for predicting crown fire occurrence and crown fire rate of spread. Adapted from Rothermel 1983.

### Models, Systems, and Other Decision Aids for Predicting Crown Fire Behavior

#### Rothermel Guide to Predicting Size and Behavior of Crown Fires

Rothermel (1972) developed a model for predicting surface fire rate of spread and intensity that still forms the basis for the vast majority of guides and computerized decision supports for predicting fire behavior in use today in the United States. He acknowledged that his model was not applicable to predicting the behavior of crown fires because the nature and mechanisms of heat transfer between the two spread regimes were quite different. In the mid to late 1970s, the general guidance to gauging whether crowning was possible or not was to use the predicted surface fireline intensity or flame length (table 8-1). There was no method at that time for predicting the spread rate of crown fires, but by the early 1980s, the suggestion was being made to assume that crown

fire rate of spread would be two to four times that of the predicted surface fire rate of spread of Anderson’s (1982) Fire Behavior Fuel Model 10 (Rothermel 1983).

The 1988 fires in the Great Yellowstone Area are generally regarded as the impetus for developing a more robust method of predicting crown fire behavior in conifer forests (Alexander 2009), although such a general need had been recognized for many years (e.g., USDA FS 1980). Rothermel (1991) produced such a guide for the northern Rocky Mountains or mountainous areas with similar fuels and climate using currently available information, including the method of estimating fine dead fuel moisture content (table 8-2) given in Rothermel (1983). The core component of his method or approach was a simple correlation derived from eight wildfire observations of crown fire rate of spread and the corresponding predictions from his surface fire rate of spread model (i.e., a 3.34 multiplier as opposed to 2.0 to



4.0 as suggested earlier). Rothermel (1991) also included an adjustment factor (1.7) for estimating the near-maximum crown fire rate of spread associated with upslope runs or sudden surges in crown fire activity.

Rothermel (1991) emphasized that his statistical model for predicting the spread rate of wind-driven crown fires was a first approximation and that more research was needed to strengthen the analysis. At the time, he did not explicitly include any specific criteria for determining the onset of crowning other than in the most general terms (e.g., examine the fire weather forecast).

Rothermel (1991) considered his predictive methods were not applicable to plume-dominated crown fire. However, he did end up incorporating Byram's (1959b) ratio of the power of the fire versus power of the wind concepts (Nelson 1993) into his guide so as to distinguish the conditions favorable for plume-dominated crown fires as opposed to wind-driven crown fires. Neither Byram's (1959b) criteria nor Rothermel's (1991) adaptation of Byram's criteria have been evaluated for their robustness.

Rothermel's (1991) guide included a suggested method of predicting the flame lengths of crown fires. However, neither his suggestion nor the approach of others seems to work consistently well based on comparisons against data from experimental crown fires. Furthermore, his model for predicting the L:B of crown fires based on windspeed does not appear to produce realistic results in light of observational evidence (fig. 8-10).

## U.S. Fire Modeling Systems

Since the late 1990s, a number of existing and newly developed decision-support systems have either separately implemented or linked Rothermel's (1972, 1991) surface and crown rate of fire spread models with Van Wagner's (1977a, 1993) crown fire transition and propagation criteria. These include:

- BehavePlus (Andrews et al. 2008)
- FARSITE (Finney 2004)
- NEXUS (Scott and Reinhardt 2001)

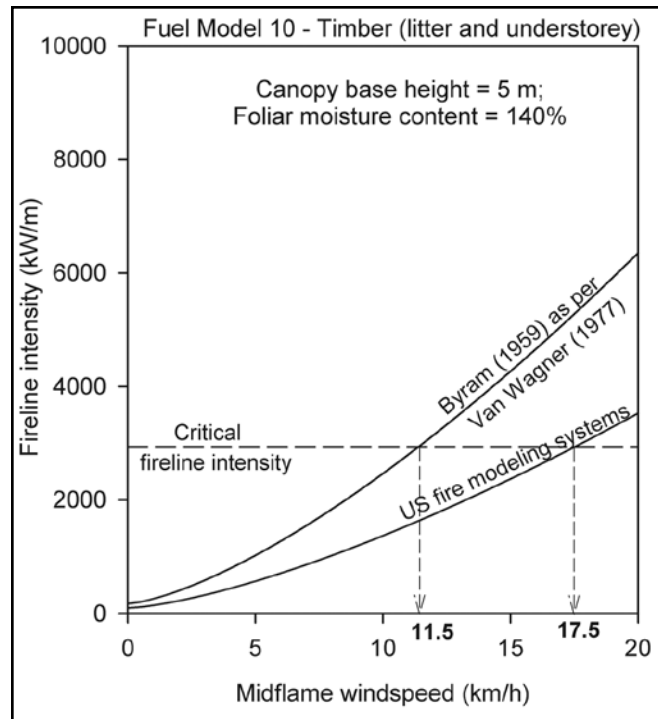

Figure 8-13—An example of the differences in the critical midflame windspeeds required for the onset of crowning resulting from the implementation of Van Wagner's (1977a) crown fire initiation model in various U.S. fire modeling systems for fuel models 2 and 10 as described by Anderson (1982) (adapted from Cruz and Alexander 2010). The following environmental conditions were held constant: slope steepness, 0 percent; fine dead fuel moisture, 4 percent; 10-h and 100-h time lag dead fuel moisture contents, 5 and 6 percent, respectively; live woody fuel moisture content, 75 percent; and live herbaceous fuel moisture content, 75 percent. The associated 6.1-m open winds would be a function of forest structure and can be approximated by multiplying the midflame windspeed by a factor ranging between 2.5 (open stand) and 6.0 (dense stand with high crown ratio) (Albini and Baughman 1979).

- Fire and Fuels Extension to the Forest Vegetation Simulator (FFE-FVS) (Reinhardt and Crookston 2003)
- Fuel Management Analyst (FMA) Plus (Carlton 2005)
- FlamMap (Finney 2006)

To this list, we can also add two additional geographic information system-based decision-support systems, namely ArcFuels (Ager et al. 2011) and the Wildland Fire Decision Support System (WFDSS) (Pence and Zimmerman 2011).

Figure 8-14—Observed head fire rates of spread >1.0 m/min associated with prescribed burning experiments in ponderosa pine forests of Yosemite National Park, California, versus predictions based on the Rothermel (1972) surface fire rate of spread model for fuel model 9-hardwood litter as described by Anderson (1982) (adapted from van Wagtenonk and Botti 1984). The dashed lines around the line of perfect agreement indicate the ± 25-percent error interval. Similar prediction trends were observed in mixed-conifer pine, mixed-conifer fir, and true fir forest fuel types.

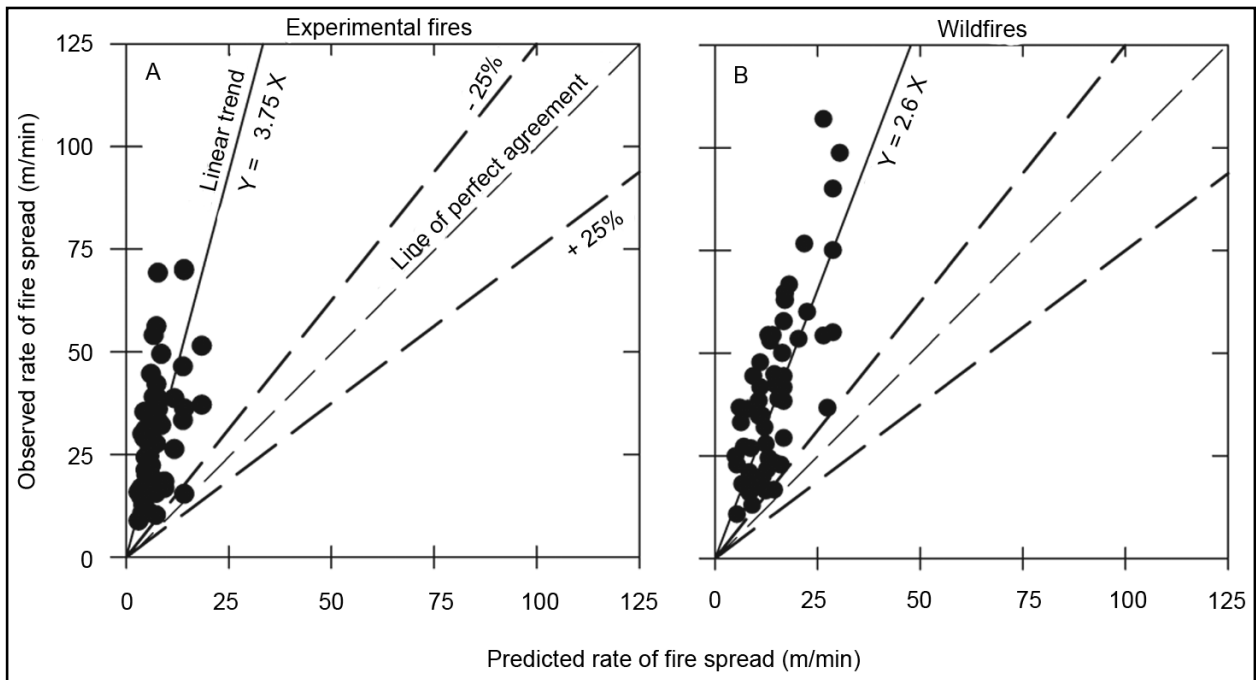
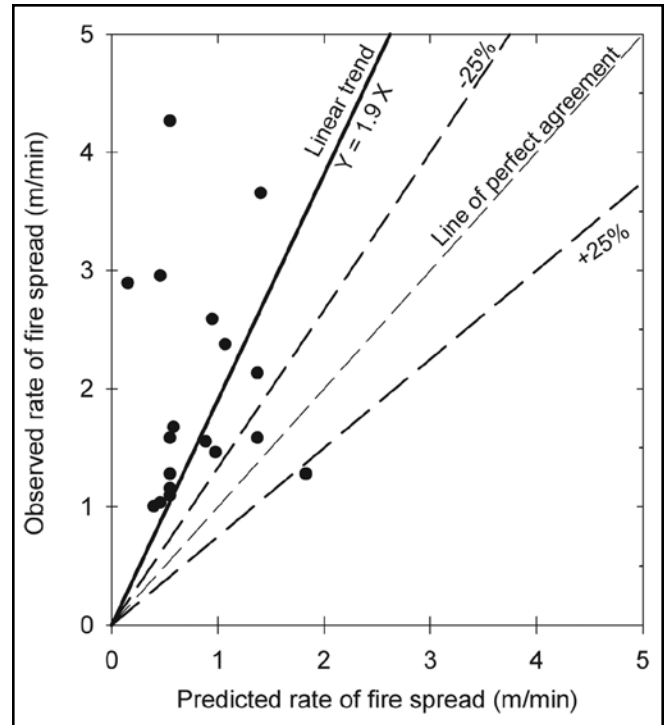

Figure 8-15—Observed rates of spread of experimental active crown fires and wildfires that exhibited extensive active crowning versus predictions based on Rothermel’s (1991) crown fire rate of spread model (adapted from Cruz and Alexander 2010). The dashed lines around the line of perfect agreement indicate the ± 25-percent error interval.

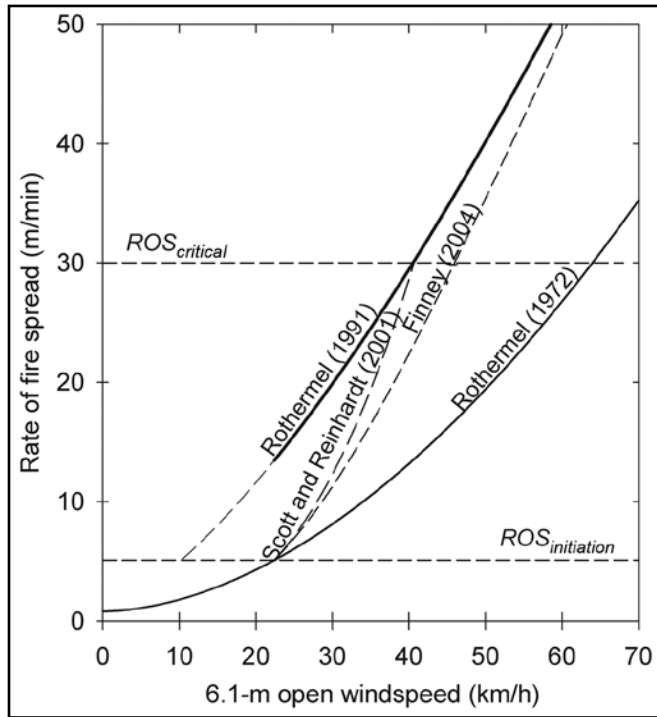

Figure 8-16—Comparison of the effect of crown fraction burned (CFB) functions on rate of fire spread developed by Scott and Reinhardt (2001) and Finney (2004) as used in various U.S. fire modeling systems (e.g., NEXUS, FFE-FVS, FARSITE, FlamMap) in relation to the Rothermel (1972, 1991) surface and crown fire rate of spread models and Van Wagner's (1977a) criteria for the critical minimum spread rates for crown fire initiation ( $ROS_{initiation}$ ) and active crowning ( $ROS_{critical}$ ) for the Anderson (1982) Fire Behavior Fuel Model 2—Timber (grass and understory) with a wind reduction factor of 0.2 (Albini and Baughman 1979), a canopy bulk density of  $0.1 \text{ kg/m}^3$ , and canopy base height of 1.5 m (adapted from Cruz and Alexander 2010). A CFB function is not employed in BehavePlus. The following environmental conditions were held constant: slope steepness, 0 percent; fine dead fuel moisture, 6 percent; 10-h and 100-h time lag dead fuel moisture contents, 7 and 8 percent, respectively; live woody fuel moisture content, 75 percent; live herbaceous fuel moisture content, 75 percent; and foliar moisture content, 140 percent. The dashed portion of the Rothermel (1991) curve represents output below the original data set bounds for rate of spread. The Beaufort scale for estimating 6.1-m open windspeeds is presented in table 8-4.

These modeling systems are extensively used for fire operations, planning, and research. A recent review of the use of many of these fire modeling systems in several simulation studies examining fuel treatment effectiveness, revealed that many users are unaware of a significant underprediction bias that exists within these systems when it comes to assessing potential crown fire behavior in conifer forests of western North America (Cruz and Alexander 2010). The principal sources of this underprediction bias have been shown to include (i) incompatible model linkages (fig. 8-13), (ii) use of surface and crown fire rate of spread models that have inherent underprediction biases themselves (figs. 8-14 and 8-15), and (iii) a reduction in crown fire rate of spread based on the use of unsubstantiated crown fraction burned functions (fig. 8-16). The use of uncalibrated custom fuel models to represent surface fuelbeds was also identified as a fourth potential source of bias (Cruz and Fernandes 2008). The underprediction tendency was found to occur as well with the crown fire rate of spread model in the Fuel Characteristic Classification System (Schaaf et al. 2007). The Cruz and Alexander

(2010) review also highlighted some issues with the manner in which users have been handling certain inputs in their crown fire modeling (i.e., foliar moisture content, canopy base height, and canopy bulk density) and in some perceived shortcomings of the two windspeed-based crown fire hazard indices developed by Scott and Reinhardt (2001).

### Canadian Forest Fire Behavior Prediction System

Do alternative methods exist for predicting crown fire behavior? The Canadian Forest Fire Behavior Prediction (FBP) System (Forestry Canada Fire Danger Group 1992, Taylor et al. 1997, Wotton et al. 2009) constitutes one such possibility, at least for certain regions of the United States possessing fuel complexes structurally similar to those found in adjacent areas of Canada. The FBP System is a module of the larger Canadian Forest Fire Danger Rating System (CFFDRS), which also includes the Canadian Forest Fire Weather Index (FWI) System (Van Wagner 1987). Some states have adopted all or part of the CFFDRS (e.g., Alaska, Minnesota, Michigan).

**Table 8-3—Type of fire as a function of the Initial Spread Index (ISI) component of the Canadian Forest Fire Weather Index (FWI) System for the coniferous (C) forest fuel types found in the Canadian Forest Fire Behavior Prediction System**

Fuel type	Descriptive name	Surface fire	Passive crown fire	Active crown fire
C-1	Spruce-lichen woodland	<8	9 to 15	>16
C-2	Boreal spruce	<1	2 to 7	>8
C-3	Mature jack or lodgepole pine	<9	10 to 15	>16
C-4	Immature jack or lodgepole pine	<2	3 to 8	>9
C-5	Red and white pine	<25	26 to 40	>41
C-6	Conifer plantation	<8	9 to 17	>18
C-7	Ponderosa pine/Douglas-fir	<15	16 to 30	>31

The ISI is a relative numerical rating that combines the effects of fine fuel moisture (based on past and current weather conditions) and windspeed on the expected rate of fire spread. In the above tabulation, level terrain, a foliar moisture content of 97 percent, and a buildup index (BUI) of 81 to 120 is assumed. The BUI component of the FWI System is a relative numerical rating of the fuel available for combustion based on fuel dryness as determined by past and current weather conditions (Van Wagner 1987). In addition, a canopy base height of 7.0 m has been assigned to fuel type C-6. Adapted from Taylor et al. 1997.

The FBP System provides estimates of head fire spread rate, fuel consumption, fireline intensity, type of fire description (table 8-3), and with the aid of an elliptical fire growth model, it gives estimates of fire area, perimeter, and perimeter growth rate as well as flank and backfire behavior characteristics for 16 major fuel types, 11 of which are subject to crowning (i.e., 7 coniferous and 4 mixed-wood types). The FBP System includes functions for the acceleration in rate of fire spread for a point source ignition to a quasi-steady-state equilibrium (McAlpine and Wakimoto 1991), including a prediction of the elapsed time to crown fire initiation. Emphasis is placed on the influences of fire weather (i.e., fuel moisture and wind) on potential fire behavior for a given fuel type and the mechanical effects of slope steepness. The FBP System forms the basis for a major component of PROMETHEUS—the Canadian wildland fire growth simulation model (Tymstra et al. 2010), which is similar to FARSITE.

The FBP System is similar in many respects to predictive systems currently used in the United States. The principal difference is in the technical basis. The Rothermel (1972) surface fire model is based largely on laboratory fires and physical theory. The FBP System, on the other hand, is largely empirically based, representing the culmination of nearly 30 years of outdoor experimental burning work

in major Canadian fuel types coupled with monitoring and documentation of numerous high-intensity wildfires.

### Other Empirically Based Approaches

Another possibility in lieu of the Canadian FBP System is the suite of empirically based models for predicting fire behavior incorporated into the Crown Fire Initiation and Spread (CFIS) software system (Alexander et al. 2006). These models are based largely on a reanalysis of the experimental fires carried out as part of developing the Canadian FBP System. The main outputs of CFIS are:

- Likelihood of crown fire initiation or occurrence based on two distinct approaches, one of which relies on the CBH or certain components of the Canadian FWI System (Cruz et al. 2003b), whereas the other is determined by the fine dead fuel moisture (table 8-2), CBH, windspeed, and an estimate of surface fuel consumption (Cruz et al. 2004) (fig. 8-17).
- Type of crown fire (passive crown fire or active crown fire) and its associated rate of spread based on fine dead fuel moisture, CBD and windspeed (Cruz et al. 2005) (figs. 8-18 and 8-19).
- Minimum spotting distance required to increase a crown fire’s overall forward rate of spread assuming a point ignition and subsequent fire acceleration to

**Table 8-4—Beaufort scale for estimating 6.1-m open windspeeds**

Wind class	Windspeed range	Description	Observed wind effects
	<i>km/h</i>		
1	<5	Very light	Smoke rises nearly vertically. Leaves of quaking aspen in constant motion; small branches of bushes sway; slender branchlets and twigs of trees move gently; tall grasses and weeds sway and bend with wind; wind vane barely moves.
2	6 to 11	Light	Trees of pole size in the open sway gently; wind felt distinctly on face; loose scraps of paper move; wind flutters small flag.
3	12 to 19	Gentle breeze	Trees of pole size in the open sway very noticeably; large branches of pole-size trees in the open toss; tops of trees in dense stands sway; wind extends small flag; a few crested waves form on lakes.
4	20 to 29	Moderate breeze	Trees of pole size in the open sway violently; whole trees in dense stands sway noticeably; dust is raised in the road.
5	30 to 39	Fresh	Branchlets are broken from trees; inconvenience is felt walking against wind.
6	40 to 50	Strong	Tree damage increases with occasional breaking of exposed tops and branches; progress impeded when walking against wind; light structural damage to buildings.
7	51 to 61	Moderate gale	Severe damage to tree tops; very difficult to walk into wind; significant structural damage occurs.
8	>62	Fresh gale	Surfaced strong Santa Ana; intense stress on all exposed objects, vegetation, buildings; canopy offers virtually no protection; windflow is systematic in disturbing everything in its path.

Adapted from Rothermel 1983.

an equilibrium rate of spread based on the presumed crown fire rate of spread and ignition delay (Alexander and Cruz 2006) (fig. 8-12).

The primary models incorporated into CFIS have been evaluated against both outdoor experimental fires and wild-fire observations and shown to be reasonably reliable (e.g., Alexander and Cruz 2006, Cronan and Jandt 2008, Stocks et al. 2004). The CFIS does allow one to evaluate the impacts of proposed fuel treatments on potential crown fire behavior based on the ability to manipulate three characteristics of a forest fuel complex (i.e., available surface fuel load, CBH and CBD) using silvicultural techniques.

The CFIS system is considered most applicable to free-burning fires that have reached a pseudo steady state, burning in live, boreal, or near-boreal type conifer forests found in western and northern North America (i.e., they are not applicable to insect-killed or otherwise “dead” stands).

Furthermore, the models underlying CFIS are not applicable to prescribed fire or wildfire situations that involve strong convection activity as a result of the ignition pattern. Level terrain is assumed, as the CFIS does not presently consider the mechanical effects of slope steepness on crown fire behavior, although this is being planned for in a future version of the system.

### Physically Based Models

Physically based models are formulated on the basis of the chemistry and physics of combustion and heat transfer processes involved in a wildland fire. They range in complexity from models for calculating rate of fire spread based solely on the radiation from the flaming front (e.g., Albini 1996) to three-dimensional models coupling fire and atmospheric processes. Examples of the latter include FIRETEC (Linn et al. 2002), FIRESTAR (Dupuy and Morvan 2005), and Wildland Fire Dynamics Simulator (WFDS) (Mell et al.

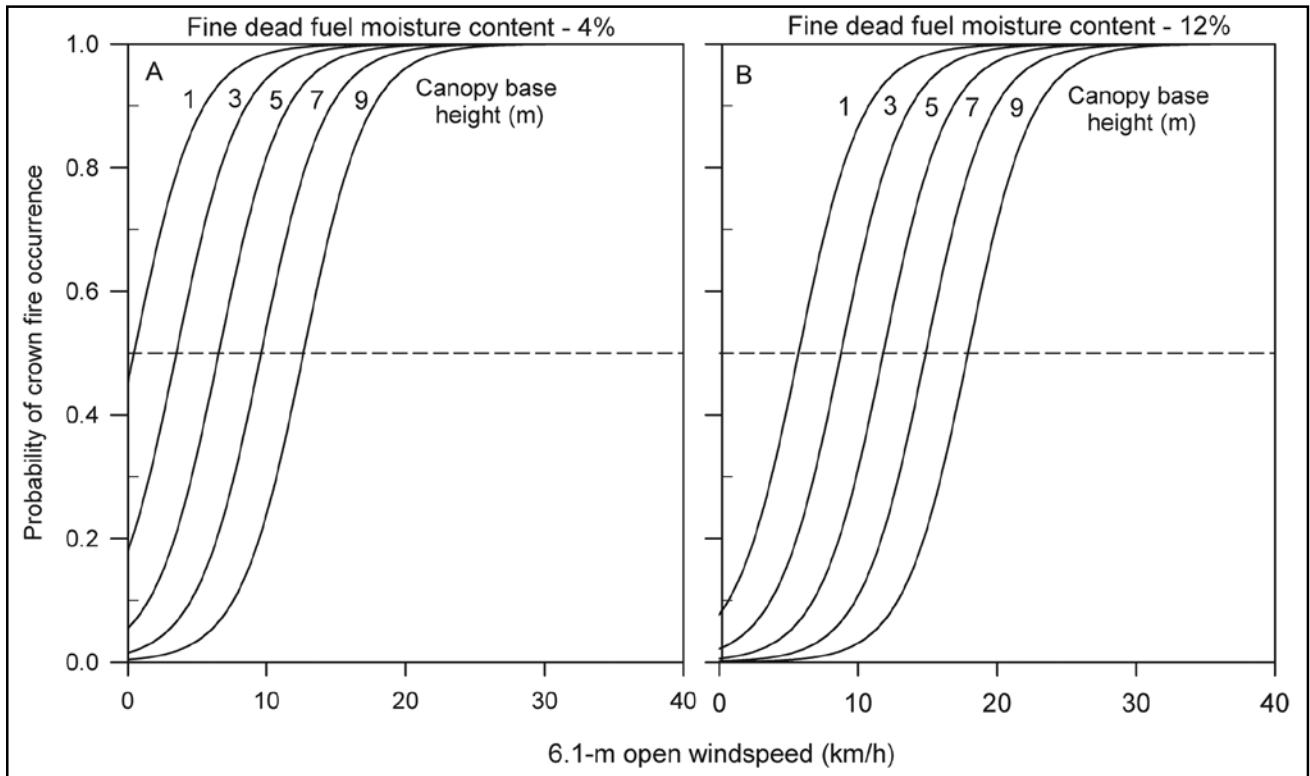

Figure 8-17—The likelihood of crown fire occurrence as a function of canopy base height and windspeed for two fine dead fuel moisture levels, assuming a surface fuel consumption of 1.0 to 2.0 kg/m<sup>2</sup>, based on the Cruz et al. (2004) probability model. The horizontal dashed line in each graph represents the approximate threshold value for the onset of crowning. The Beaufort scale for estimating 6.1-m open windspeeds is presented in table 8-4.

2007). Physically based models hold great promise in being able to advance our theoretical understanding of wildland fire dynamics and could possibly be used for operational prediction of wildland fire behavior in the future (Sullivan 2009b). By their completeness, these models should be able to predict the development, the demise or cessation, spread rate, fuel consumption, intensity, and flame dimensions of crown fires in relation to any combination of fuel, weather, and topographic variables. In recent years, these models have been extensively used as research tools to evaluate the effect of canopy fuel structure on crown fire dynamics. Such modelling efforts could possibly allow one to investigate the effect of fuel treatments on crown fire potential. Nonetheless, the capacity of these models to describe crown fire behavior is still open to question given that no evaluation against any empirical crown fire data set has been undertaken to date to our knowledge.

What is quite likely to happen is the continuing emergence of empirical and physically based approaches (Sullivan 2009b, Van Wagner 1985). An example of such an approach is the semiphysically based crown fuel ignition model (CFIM) developed by Cruz et al. (2006b) to predict the onset of crowning based on fundamental heat transfer principles. A series of submodels that take into account surface fire characteristics along with canopy fuel properties are used to predict the ignition temperature of canopy fuels above a spreading surface fire. An evaluation of CFIM has been undertaken involving a sensitivity analysis of input parameters, comparison against other similar models under different burning conditions, and testing against outdoor experimental fires (Cruz et al. 2006a). Results have been favorable and provided new insights into the factors controlling the initiation of crown fires.



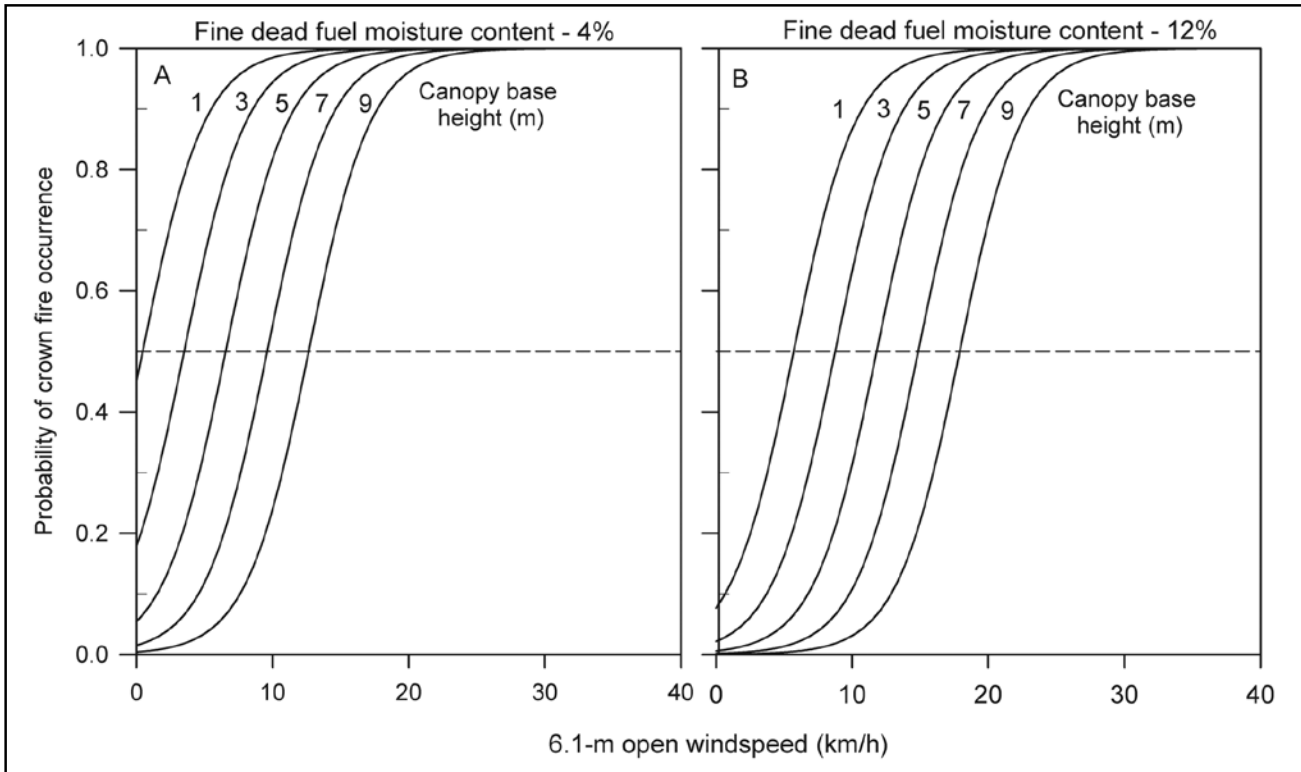

Figure 8-18—Threshold conditions for passive versus active crown fire spread in terms of windspeed and fine dead fuel moisture for two canopy bulk density levels based on the Cruz et al. (2005) crown fire rate of spread models and Van Wagner’s (1977a) criteria for active crowning. The Beaufort scale for estimating 6.1-m open windspeeds is presented in table 8-4.

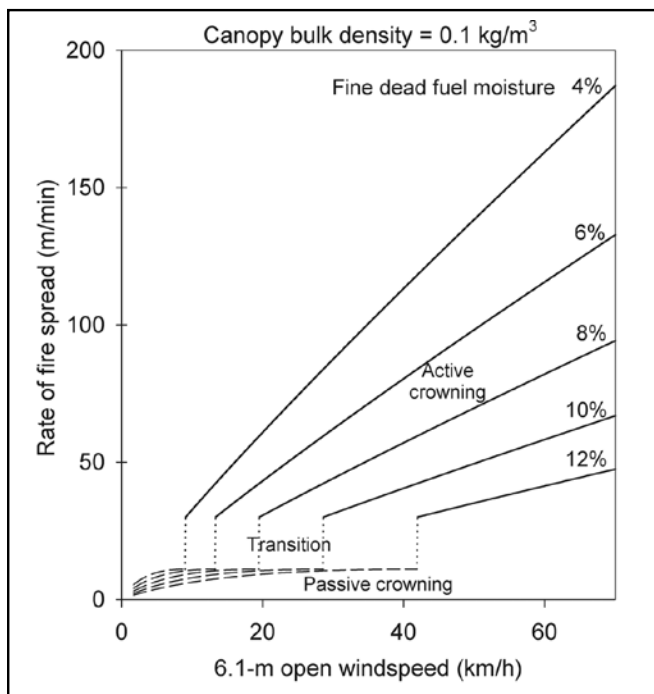

Figure 8-19—Passive and active crown fire spread rates as a function of windspeed and fine dead fuel moisture for a canopy bulk density of 0.1 kg/m<sup>3</sup> based on the Cruz et al. (2005) crown fire rate of spread models. The vertical “kinks” in the fine dead fuel moisture curves are considered to represent the windspeed thresholds between passive and active crowning. The Beaufort scale for estimating 6.1-m open windspeeds is presented in table 8-4.

Another example of the merging of empirical and physical modelling approaches was the International Crown Fire Modeling Experiment (ICFME). One of the objectives of this experimental burning program carried out in the Northwest Territories of Canada from 1995 to 2001 (Alexander 2005) was to test a newly developed, deterministic physical model for predicting crown fire rate of spread (Albini 1996, Butler et al. 2004). Measurements of flame radiometric properties and temperatures allowed for the parameterizing of the heat transfer components in Albini's (1996) crown fire rate of spread model. Model evaluation indicated that the model predicted the relative response of fire spread rate to fuel and environmental variables, but it consistently overpredicted the magnitude of the spread rates observed on the ICFME crown fires.

Not all physically based models for predicting wildland fire spread specifically take into account the effects of spotting in increasing a fire's rate of spread. The effects of spotting on a fire's overall rate of advance are implicitly accounted for in both the FBP System and the Rothermel (1991) crown fire rate of spread model as a result of the empirical nature of their development (i.e., the use of wildfire observations as a data source). This assumes, however, that the fuels are continuous. Neither approach indicates how barriers to fire spread are to be handled. Short-range spotting from a crown fire is presumably able to easily breach fuel discontinuities of up to 100 m in width (Stocks et al. 2004, Taylor et al. 2004). Nominal spotting from crown fires is undoubtedly capable of breaching even much wider barriers, perhaps up to 1000 m (Alexander et al. 2004). What is unknown, however, is how much of a reduction there will be in the head fire rate of spread as a result of the time delay involved (which might possibly be 30 to 60 min or longer) for the fire to resume its forward, equilibrium rate of advance.

Albini (1979) developed a physically based model for predicting the maximum spotting distance from single or group tree torching that covers the case of intermediate-range spotting of up to perhaps 3.0 km. This model is

included within the BehavePlus modeling system, and a manual procedure is given in Rothermel (1983). Rothermel (1991) pointed out at the time he prepared his guide that no model existed for predicting the spotting distances for running or active crown fires. Venkatesh et al. (2000) subsequently extended Albini's (1979) model to the case of wind-driven crown fires. The result was a 20- to 25-percent increase in spotting distance. However, no testing of this model has been undertaken to date to our knowledge. The Venkatesh et al. (2000) model like the one developed by Albini (1979) provides a prediction of the firebrand transport distance. Determining whether a given ember or firebrand will actually cause a spot fire must still be assessed based on its ignition probability (e.g., Rothermel 1983).

More recently, an alternative predictive system has been put forth for estimating the maximum spotting distance from active crown fires as a function of the firebrand particle diameter at alighting based on three inputs, namely, canopy top height, free flame height (i.e., flame distance above the canopy top height), and the windspeed at the height of the canopy.<sup>2</sup> Although the system has not been specifically validated, the estimates produced by the system appear realistic in light of existing documented observations.

### Example of a Practical Application of Linking Empirical and Physically Based Models

Pine Plantation Pyrometrics (PPPY) is a new modeling system developed to predict fire behavior in industrial pine plantations over the full range of burning conditions in relation to proposed changes in fuel complex structure from fuel treatments (Cruz et al. 2008). The system comprises a series of submodels, including CFIM and elements of CFIS, that describe surface fire characteristics and crown fire potential in relation to the surface and crown fuel structures, fuel moisture contents, and windspeed (fig. 8-20). A case study application of the PPPY modeling system has highlighted the complex interactions associated with fuel

<sup>2</sup> Albini, F.A.; Alexander, M.E.; Cruz, M.G. Predicting the maximum potential spotting distance from an active crown fire. Under review.

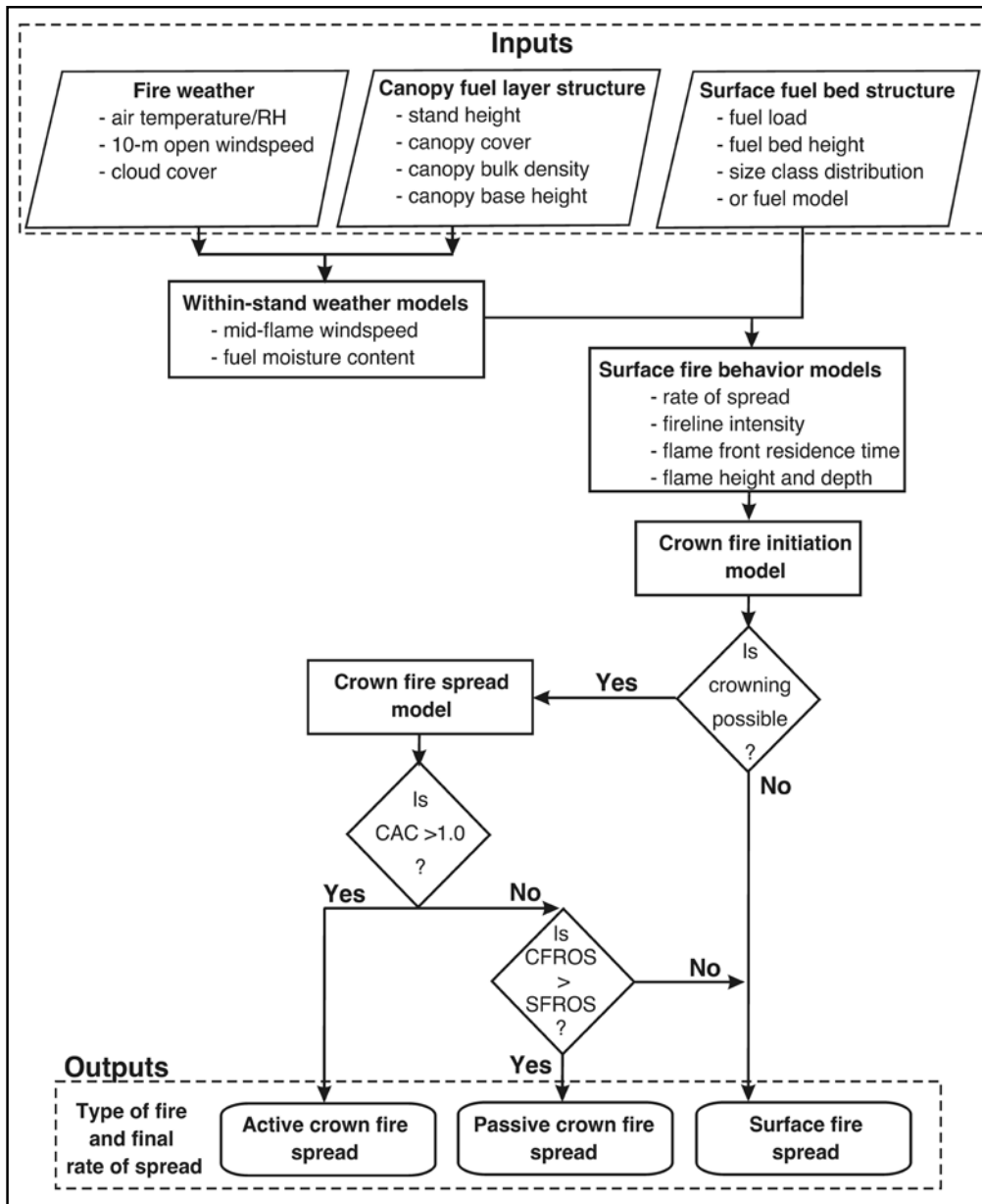

Figure 8-20—Flow diagram of the Pine Plantation Pyrometrics modeling system for predicting fire behavior in exotic pine plantations (adapted from Cruz et al. 2008). CAC is the criteria for active crowning (Van Wagner (1977a), CFROS is the crown fire rate of spread, and SFROS is the surface fire rate of spread.

treatments such as pruning and thinning have on surface and crown fire behavior potential (fig. 8-21). It is also noteworthy that no definite reduction or increase in rate of spread was identified. Although a direct evaluation of the system’s overall performance has yet to be undertaken, its

main components have been evaluated against independent data sets.

### Implications for Fire and Fuel Management

In the broadest sense, the general conditions favorable for the development of crowning in conifer forests have

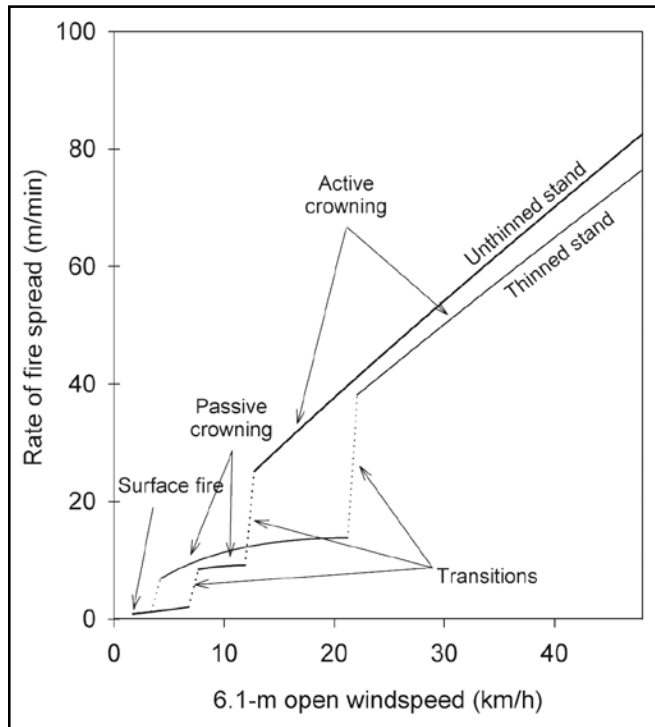

Figure 8-21—Head fire rate of spread as a function of windspeed for 12-year-old thinned (50 percent basal area reduction treatment) and unthinned pine plantation stands based on the Pine Plantation Pyrometrics (PPPY) modeling system (adapted from Cruz et al. 2008). The fuel complex characteristics for the thinned and unthinned stands were, respectively, surface fuel available for combustion, 1.1 and 0.5 kg/m<sup>2</sup>; canopy base height, 1.7 and 0.9 m; and canopy bulk density, 0.05 and 0.1 kg/m<sup>3</sup>. Given an air temperature of 40 °C and a relative humidity of 20 percent, the fine dead fuel moistures for the surface litter were, in turn, judged to be 5 and 7 percent, respectively. Foliar moisture content was set at 100 percent in both cases, and level terrain was assumed. The Beaufort scale for estimating 6.1-m open windspeeds is presented in table 8-4.

been known for some time and also apply to nonforested fuel types as well that exhibit high rates of fire spread and fireline intensities or very long flame lengths (e.g., Butler and Reynolds 1997). These include:

- Continuous fine fuels in sufficient quantity and arrangement, both vertically and horizontally.
- A dry spell of sufficient length to reduce the moisture content of dead fuels to a uniformly low level coupled with high ambient air temperatures and low relative humidity.

- Strong prevailing winds or steep slopes.

In the past 25 years or so, these conditions have, in turn, been crudely codified in various forms suitable for use by field personnel. Other aspects of the fire environment may lead to an increase in crown fire potential but by themselves are not a major predisposing factor (e.g., low foliar moisture content, high foliar heat content, presence of flammable oils and resins in the needle foliage).

Assuming a threshold level in dryness has been reached in the forest floor layer, the potential for crown fire development and spread would generally follow the daily diurnal cycle in fire weather conditions, typically peaking in late afternoon (Beck et al. 2002). However, crown fire activity can extend late into the day if fire weather conditions are favorable for maintaining the moisture content of fine, dead surface fuels at low levels (Hartford and Rothermel 1991).

Rothermel (1991) quite rightly pointed out that “Fires are seldom uniform and well behaved.” Given the chaotic nature of most extreme fire phenomena, can we expect the behavior of crown fires to ever really be truly predictable? That depends on how accurate you expect the prediction to be. Certainly the minute-by-minute movement of a crown fire will probably never be predictable. However, in looking at crown fire propagation across longer timeframes, for example (e.g., 30 min to several hours), the available data have shown that some models are very capable of predicting fire spread within a margin of error that is useful to fire managers. Nevertheless, given the coarseness and uncertainty associated with the inputs in the crown fire initiation and propagation models, managers should be wary of their use for near-real-time predictions of fire behavior. Underestimating the potential for the onset of crowning under conditions that would sustain active crown fire propagation can, in turn, lead to substantial underpredictions in crown fire rate of spread and fireline intensity.

Models or guides that have a good fundamental framework and a solid empirical basis presumably predict fire behavior well when used for conditions that are within the data range used in their development (Sullivan 2009a). Overestimates of fire behavior can easily be readjusted

**Box 3:****Useful Links to Further Information**

U.S. Fire Modeling Systems

- <http://www.firemodels.org/>

Canadian Forest Fire Danger Rating Systems

- <http://frames.nbii.gov/cffdrs>
- [http://cwffis.cfs.nrcan.gc.ca/en\\_CA/background/summary/fdr](http://cwffis.cfs.nrcan.gc.ca/en_CA/background/summary/fdr)

Crown Fire Initiation and Spread System

- <http://frames.nbii.gov/cfis>

International Crown Fire Modeling Experiment

- <http://frames.nbii.gov/icfme>
- <http://www.youtube.com/watch?v=FYup7cYKE3w>
- [http://www.youtube.com/watch?v=zvPa\\_yEEd4E](http://www.youtube.com/watch?v=zvPa_yEEd4E)

Joint Fire Science Program Crown Fire Synthesis Project

- <http://www.fs.fed.us/wwetac/projects/alexander.html>
- <http://www.myfirecommunity.net/Neighborhood.aspx?ID=816>

**Box 4:****Crown Fire Dynamics in Conifer Forests—A Summary of the Salient Points****Types of Crown Fires**

Three kinds or classes of crown fire are recognized according to their degree of dependence on the surface phase of fire spread (i.e., passive, active, and independent, although the latter is generally regarded as a rare and short-lived occurrence).

**Crown Fire Initiation**

The amount of heat energy required in the form of convection and radiation to induce the onset of crowning is dictated by the canopy base height and foliar moisture content as manifested in the surface fire's intensity. A rather abrupt increase in fire activity should be expected as a fire transitions from the surface to crown fire phase.

**Crown Fire Propagation**

Whether a passive or active crown fire develops following the onset of crowning depends on the spread rate after initial crown combustion and is, in turn, related to canopy bulk density. A minimum value of about  $0.1 \text{ kg/m}^3$  appears to represent a critical threshold for active crowning.

### **Box 4: continued**

#### **Crown Fire Rate of Spread**

At a minimum, a doubling or tripling in a fire's rate of advance follows the onset of crowning. Wind-driven crown fires have been documented to spread at up to 100 m/min for several hours and in excess of 200 m/min for up to an hour. Although the mechanical effect of slope steepness on increasing a fire's rate of spread is well known, fires in mountainous terrain generally do not spread nearly as far for a given period of time compared to those on flat topography.

#### **Crown Fire Intensity and Flame Zone Characteristics**

As a result of the increase in spread rate and fuel available for combustion, a fire can easily quadruple its intensity in a matter of seconds when crowning takes place (e.g., from 3000 kW/m to 12 000 kW/m). The resulting wall of flame, standing nearly erect, is on average up to two to three times the tree height and emits fierce radiation. Flame fronts commonly exceed 30 to 45 m in depth.

#### **Crown Fire Area and Perimeter Growth**

The area burned by a crown fire is at least four to nine times that of a surface fire for the same period.

### **Box 4: continued**

Assuming unlimited horizontal fuel continuity, crown fires are capable of burning an area of up to 70 000 ha with a perimeter length of 160 km in a single burning period and have done so in the past.

#### **Crown Fire Spotting Activity**

Crown fires commonly display high-density, short-range spotting (<50 m). Spotting distances of up to about 2.0 km, although less common, are frequently seen on crown fires, resulting in normal barriers to fire spread being breached. Many spot fires are simply overrun by the main advancing flame front of a crown fire before they effectively contribute to an increase in the fire's overall rate of advance. Cases of long-distance spotting in excess of 10 km have been reported.

#### **Models, Systems, and Other Decision Aids for Predicting Crown Fire Behavior**

The current set of guides and decision-support system for assessing potential crown fire behavior used in the United States are considered deficient in the absence of considerable adjustment on the part of trained and informed users (e.g., fire behavior analysts, long-term fire analysts). Alternative models and systems that have undergone far more



**Box 4: continued**

extensive testing and requiring a minimum of inputs are available.

**Implications for Fire and Fuel Management**

Operational fire management personnel can readily help themselves when it comes to being able to assess crown fire behavior by engaging in a more rigorous program of wildfire monitoring and case study documentation than has been undertaken to date.

without serious consequences. However, underestimates can be potentially disastrous (Cheney 1981). In this regard, the underprediction trend in predictions of crown fire behavior evident in the existing fire modeling systems used in the United States is of concern on a number of fronts. For example, if a system predicts or simulates that a fire will behave as a moderate-intensity surface fire under extreme fire weather conditions, why would it be necessary to undertake any form of fuel treatment or even be concerned about the general flammability of an area? As for human safety, if people are led to believe that some stand structures will not support crowning under a given set of weather conditions—but in actual fact they will—are they not putting themselves and others in grave danger?

It has been suggested that most wildland fire operations personnel base their expectations of how a fire will behave largely on experience and, to a lesser extent, on guides to forecasting fire behavior (Burrows 1984). Experienced judgement is certainly needed in any assessment of wildland fire potential, but it does have some limitations (Gisborne 1948). The same can be said for mathematical models and computerized decision-support systems. Given

the present realities, practical knowledge and sound professional judgment coupled with experience is still needed and perhaps should take on an even more prominent role when it comes to adjusting, interpreting, and applying crown fire behavior predictions. Predicting wildland fire behavior is, after all, both an “art and a science.”

Wildland fire research has done much to contribute to our current understanding of crown fire behavior through laboratory experiments, outdoor experimental burning, numerical modeling, and wildfire case histories (box 3). Although operational fire behavior specialists have also made substantial contributions (e.g., Beighley and Bishop 1990, Murphy et al. 2007), valuable information and insights are not being captured in a systematic way. The continuance of basic research into fire fundamentals is essential to gaining a complete understanding of crown fire behavior, but scientific knowledge alone will not be enough to develop a complete picture of crown fire dynamics. There is still an overriding need to bolster the efforts in observing crown fire behavior and completing the necessary case study documentation in order to evaluate new and existing predictive models of crown fire behavior. Such a program should be regarded as a shared responsibility between wildland fire research and fire management and be considered part of adaptive management (Alexander and Taylor 2010).

**Future Outlook**

In discussing his dichotomous key for appraising crowning potential, Fahnestock (1970) indicated that “No technique is available for calculating the mathematical probability that a fire will crown under given conditions.” In turn, Kerr et al. (1971) considered that “In the foreseeable future there is little prospect of predicting the behavior of a fast spreading crown fire in timber over any extended period of time.” More recently, Agee (1993) stated, “The chances of firebrand spotting and crown fires can be estimated, but the behavior of crown fire is still relatively unpredictable.” In light of these comments, obviously much has been accomplished and experienced in the past 20 to 40 years

when viewed from the point of our current understanding and predictive capability with respect to crown fires (box 4).

Presumably, the future holds the same promise as the recent past provided we are willing to readily admit what we know and, more importantly, what we presumably still do not know about crown fires with respect to their environment, characteristics, and prediction. Several knowledge gaps have been alluded to throughout this summary. Furthermore, a good many basic wildland fire behavior research needs identified over 25 years ago, some of which are relevant to crown fires, have yet to be addressed (Albini 1984). Research must be directed at both the operational products desired by fire and fuel managers, and the fundamental understanding that forms the basis for such end-user tools (Cohen 1990).

Further discoveries and advancements in understanding of crown fire dynamics in conifer forests will require a dedication in time, money, and staff (Blatchford 1972). In actual fact, new research into the complexities of crown fire phenomenology has already been initiated (e.g., Cruz and Alexander 2009). However, in the long run, scientific investigations into crown fire behavior might be best accomplished in the form of a collaborative, international research, development, and application effort (Christensen et al. 2007, Weber 1995). Networked, multidisciplinary teams that can build on extant understanding while creating new knowledge regarding the mechanisms associated with crown fire initiation and spread may provide the necessary platform.

## Literature Cited

- Agee, J.K. 1993.** Fire ecology of Pacific Northwest forests. Washington, DC: Island Press. 493 p.
- Agee, J.K. 1996.** The influence of forest structure on fire behavior. In: Sherlock, J., ed. Proceedings of the 17<sup>th</sup> annual forest vegetation management conference. Redding, CA: Forest Vegetation Management Conference: 52–57.
- Ager, A.A.; Vaillant, N.M.; Anderson, J.; Miller, L. 2011.** ArcFuels user guide: for use with ArcGIS 9.X. Prineville, OR: U.S. Department of Agriculture, Forest Service, Pacific Northwest Research Station, Western Wildland Environmental Threat Assessment Center. 256 p. [http://www.fs.fed.us/wwetac/arcfuels/downloads/ArcFuels\\_UserGuide.pdf](http://www.fs.fed.us/wwetac/arcfuels/downloads/ArcFuels_UserGuide.pdf). (3 February 2011).
- Albini, F.A. 1979.** Spot fire distance from burning trees—a predictive model. Gen. Tech. Rep. INT-56. Ogden, UT: U.S. Department of Agriculture, Forest Service, Intermountain Forest and Range Experiment Station. 73 p.
- Albini, F.A. 1984.** Wildland fires. *American Scientist*. 72: 590–597.
- Albini, F.A. 1993.** Dynamics and modelling of vegetation fires: observations. In: Crutzen, P.J.; Goldammer, J.G., eds. Fire in the environment: the ecological, atmospheric, and climatic importance of vegetation fires. Environ. Sci. Res. Rep. 13. Chichester, England: John Wiley & Sons: 39–52.
- Albini, F.A. 1996.** Iterative solution of the radiation transport equations governing spread of fire in wildland fuel. *Combustion, Explosion, and Shock Waves*. 32: 534–543.
- Albini, F.A.; Baughman, R.G. 1979.** Estimating windspeeds for predicting wildland fire behavior. Res. Pap. INT-221. Ogden, UT: U.S. Department of Agriculture, Forest Service, Intermountain Forest and Range Experiment Station. 12 p.
- Albini, F.A.; Stocks, B.J. 1986.** Predicted and observed rates of spread of crown fire in immature jack pine. *Combustion Science and Technology*. 48: 65–76.
- Alexander, M.E. 1982.** Calculating and interpreting forest fire intensities. *Canadian Journal of Botany*. 60: 349–357.

- Alexander, M.E. 1985.** Estimating the length-to-breadth ratio of elliptical forest fire patterns. In: Donoghue, L.R.; Martin, R.E., eds. Proceedings of eighth conference on fire and forest meteorology. SAF Publ. 85-04. Bethesda, MD: Society of American Foresters: 287–304.
- Alexander, M.E. 1988.** Help with making crown fire hazard assessments. In: Fischer, W.C.; Arno, S.F., comps. Proceedings of symposium and workshop on protecting people and homes from wildfire in the interior West. Gen. Tech. Rep. INT-251. Ogden, UT: U.S. Department of Agriculture, Forest Service, Intermountain Research Station: 147–156.
- Alexander, M.E. 1998.** Crown fire thresholds in exotic pine plantations of Australasia. Canberra, ACT: Australian National University. 228 p. Ph.D. thesis.
- Alexander, M.E. 2005.** Long-term experiment takes some of the mystery out of crown fires. *Fire Management Today*. 65(3): 36–37.
- Alexander, M.E. 2009.** The 1988 fires of Yellowstone and beyond as a wildland fire behavior case study. Tucson, AZ: U.S. Department of Agriculture, Forest Service, Wildland Fire Lessons Learned Center. 30 p. [www.wildfirelessons.net/documents/Alexander\\_Yellowstone88\\_FB.pdf](http://www.wildfirelessons.net/documents/Alexander_Yellowstone88_FB.pdf). (3 February 2010).
- Alexander, M.E.; Cruz, M.G. 2006.** Evaluating a model for predicting active crown fire rate of spread using wildfire observations. *Canadian Journal of Forest Research*. 36: 3015–3028.
- Alexander, M.E.; Cruz, M.G.; Lopes, A.M.G. 2006.** CFIS: a software tool for simulating crown fire initiation and spread. In: Viegas, D.X., ed. Proceedings of 5<sup>th</sup> international conference on forest fire research. [CD-ROM]. Amsterdam, The Netherlands: Elsevier BV. 13 p.
- Alexander, M.E.; De Groot, W.J. 1988.** Fire behavior in jack pine stands as related to the Canadian Forest Fire Weather Index (FWI) System. [Poster with text.] Edmonton, AB: Government of Canada, Canadian Forestry Service, Northern Forestry Centre.
- Alexander, M.E.; Lanoville, R.A. 1989.** Predicting fire behavior in the black spruce-lichen woodland fuel type of western and northern Canada. [Poster with text.] Edmonton, AB and Fort Smith, NT: Forestry Canada, Northern Forestry Centre and Government of Northwest Territories, Department of Renewable Resources, Territorial Forest Fire Centre.
- Alexander, M.E.; Taylor, S.W. 2010.** Wildland fire behavior case studies and the 1938 Honey Fire controversy. *Fire Management Today*. 70(1): 15–25.
- Alexander, M.E.; Tymstra, C.; Frederick, K.W. 2004.** Incorporating breaching and spotting considerations into PROMETHEUS—the Canadian wildland fire growth model. Chisholm/Dogrib Fire Res. Initiative Quicknote 6. Hinton, AB: Foothills Model Forest. 2 p.
- Anderson, H.E. 1968.** Sundance Fire: an analysis of fire phenomena. Res. Pap. INT-56. Ogden, UT: U.S. Department of Agriculture, Forest Service, Intermountain Forest and Range Experiment Station. 39 p.
- Anderson, H.E. 1982.** Aids to determining fuel models for estimating fire behavior. Gen. Tech. Rep. INT-122. Ogden, UT: U.S. Department of Agriculture, Forest Service, Intermountain Forest and Range Experiment Station. 22 p.
- Anderson, H.E. 1983.** Predicting wind-driven wild land fire size and shape. Res. Pap. INT-305. Ogden, UT: U.S. Department of Agriculture, Forest Service, Intermountain Forest and Range Experiment Station. 26 p.
- Andrews, P.L.; Bevins, C.D.; Seli, R.C. 2008.** BehavePlus fire modeling system, version 4.0: user's guide. Gen. Tech. Rep. RMRS-GTR-106WWW. Fort Collins, CO: U.S. Department of Agriculture, Forest Service, Rocky Mountain Research Station. 116 p.

- Beck, J.A.; Alexander, M.E.; Harvey, S.D.; Beaver, A.K. 2002.** Forecasting diurnal variation in fire intensity to enhance wildland firefighter safety. *International Journal of Wildland Fire*. 11: 173–182.
- Beighley, M.; Bishop, J. 1990.** Fire behavior in high-elevation timber. *Fire Management Notes*: 51(2): 23–28. [Republished in 2003 as: *Fire Management Today*. 63(4): 56–62.]
- Blatchford, A.N. 1972.** Dissemination and application of research information in the field. *Res. Develop. Pap.* 88. London, England: Forestry Commission. 5 p.
- Brown, A.A.; Davis, K.P. 1973.** *Forest fire: control and use*. 2<sup>nd</sup> ed. New York, NY: McGraw-Hill. 686 p.
- Bruner, A.D.; Klebenow, D.A. 1979.** Predicting success of prescribed fire in pinyon-juniper woodland in Nevada. *Res. Pap.* INT-219. Ogden, UT: U.S. Department of Agriculture, Forest Service, Intermountain Forest and Range Experiment Station. 12 p.
- Burgan, R.E. 1979.** Fire danger/fire behavior computations with the Texas Instruments TI-59 calculator: user's manual. *Gen. Tech. Rep.* INT-61. Ogden, UT: U.S. Department of Agriculture, Forest Service, Intermountain Forest and Range Experiment Station. 25 p.
- Burrows, N.D. 1984.** Predicting blow-up fires in the jarrah forest. *Tech. Pap.* No. 12. Perth, Western Australia: Forests Department of Western Australia. 27 p.
- Butler, B.W.; Bartlette, R.A.; Bradshaw, L.S.; Cohen, J.D.; Andrews, P.L.; Putnam, T.; Mangan, R.J. 1998.** Fire behavior associated with the 1994 South Canyon Fire on Storm King Mountain, Colorado. *Res. Pap.* RMRS-RP-9. Ogden, UT: U.S. Department of Agriculture, Forest Service, Rocky Mountain Research Station. 82 p.
- Butler, B.W.; Finney, M.A.; Andrews, P.; Albini, F.A. 2004.** A radiation-driven model of crown fire spread. *Canadian Journal of Forest Research*. 34: 1588–1599.
- Butler, B.W.; Reynolds, T.D. 1997.** Wildfire case study: Butte City Fire, southeastern Idaho, July 1, 1994. *Gen. Tech. Rep.* INT-GTR-351. Ogden, UT: U.S. Department of Agriculture, Forest Service, Intermountain Research Station. 15 p.
- Byram, G.M. 1954.** Atmospheric conditions related to blowup fires. *Stn. Pap.* No. 35. Asheville, NC: U.S. Department of Agriculture, Forest Service, Southeastern Forest Experiment Station. 34 p.
- Byram, G.M. 1959a.** Combustion of forest fuels. In: Davis, K.P., ed. *Forest fire: control and use*. New York: McGraw-Hill: 61–89.
- Byram, G.M. 1959b.** Forest fire behavior. In: Davis, K.P., ed. *Forest fire: control and use*. New York: McGraw-Hill: 90–123.
- Carlton, D. 2005.** Fuels Management Analyst Plus software, version 3. Estacada, OR: Fire Program Solutions LLC. <http://www.fireps.com/fmanalyst3/index.htm>. (8 November 2009).
- Cheney, N.P. 1981.** Fire behaviour. In: Gill, A.M.; Groves, R.H.; Noble, I.R., eds. *Fire and the Australian biota*. Canberra, ACT: Australian Academy of Science: 151–175.
- Cheney, P.; Sullivan, A. 2008.** *Grassfires: fuel, weather and fire behaviour*. Collingwood, South Australia: CSIRO Publishing. 150 p.
- Christensen, N.L. (chair); Alexander, M.E.; Benson, N.C.; Brown, T.J.; Cortner, H.J.; Omi, P.N.; Schmidt, R.G.; Shlisky, A.; Swallow, S.K. 2007.** U.S. Forest Service R&D wildland fire external peer review. Report submitted to USDA Forest Service Research and Development, Washington, DC. 25 p.

- Cohen, J.D. 1990.** Research has part of the answer. In: Are forests the answer? Proceedings of the 1990 Society of American Foresters National Convention. SAF Publ. 90-02. Bethesda, MD: Society of American Foresters: 117–120.
- Cronan, J.; Jandt, R. 2008.** How succession affects fire behavior in boreal black spruce forest of interior Alaska. BLM-Alaska Tech. Rep. 59. Anchorage, AK: U.S. Department of the Interior, Bureau of Land Management, Alaska State Office. 15 p.
- Cruz, M.G.; Alexander, M.E. 2009.** Assessing discontinuous fire behaviour and uncertainty associated with the onset of crowning [extended abstract]. In: Masters, R.E.; Galley, K.E.M.; Despain, D.G., eds. The '88 Fires: Yellowstone and beyond. Tall Timbers Misc. Publ. No. 16. Tallahassee, FL: Tall Timbers Research Station: 20.
- Cruz, M.G.; Alexander, M.E. 2010.** Assessing crown fire potential in coniferous forests of western North America: a critique of current approaches and recent simulation studies. *International Journal of Wildland Fire*. 19: 377–398.
- Cruz, M.G.; Alexander, M.E. [In press].** Evaluating regression model estimates of canopy fuel stratum characteristics in four crown fire prone fuel types in western North America. *International Journal of Wildland Fire*.
- Cruz, M.G.; Alexander, M.E.; Fernandes, P.A.M. 2008.** Development of a model system to predict wildfire behaviour in pine plantations. *Australian Forestry*. 70: 113–121.
- Cruz, M.G.; Alexander, M.E.; Wakimoto, R.H. 2003a.** Assessing canopy fuel stratum characteristics in crown fire prone fuel types of western North America. *International Journal of Wildland Fire*. 12: 39–50.
- Cruz, M.G.; Alexander, M.E.; Wakimoto, R.H. 2003b.** Assessing the probability of crown fire initiation based on fire danger indices. *Forestry Chronicle*. 79: 976–983.
- Cruz, M.G.; Alexander, M.E.; Wakimoto, R.H. 2003c.** Definition of a fire behavior model evaluation protocol: a case study application to crown fire behavior models. In: Omi, P.N.; Joyce, L.A., tech. eds. Fire, fuel treatments and ecological restoration: conference proceedings. Proc. RMRS-P-29. Fort Collins, CO: U.S. Department of Agriculture, Forest Service, Rocky Mountain Research Station: 49–67.
- Cruz, M.G.; Alexander, M.E.; Wakimoto, R.H. 2004.** Modeling the likelihood of crown fire occurrence in conifer forest stands. *Forest Science*. 50: 640–658.
- Cruz, M.G.; Alexander, M.E.; Wakimoto, R.H. 2005.** Development and testing of models for predicting crown fire rate of spread in conifer forest stands. *Canadian Journal of Forest Research*. 35: 1626–1639.
- Cruz, M.G.; Butler, B.W.; Alexander, M.E. 2006a.** Predicting the ignition of crown fuels above a spreading surface fire. Part II: Model behavior and evaluation. *International Journal of Wildland Fire*. 15: 61–72.
- Cruz, M.G.; Butler, B.W.; Alexander, M.E.; Forthofer, J.M.; Wakimoto, R.H. 2006b.** Predicting the ignition of crown fuels above a spreading surface fire. Part I: Model idealization. *International Journal of Wildland Fire*. 15: 47–60.
- Cruz, M.G.; Fernandes, P.M. 2008.** Development of fuel models for fire behaviour in maritime pine (*Pinus pinaster* Ait.) stands. *International Journal of Wildland Fire*. 17: 194–204.
- DeCoste, J.H.; Wade, D.D.; Deeming, J.E. 1968.** The Gaston Fire. Res. Pap. SE-43. Asheville, NC: U.S. Department of Agriculture, Forest Service, Southeastern Forest Experiment Station. 36 p.



- Dupuy, J.L.; Morvan, D. 2005.** Numerical study of a crown fire spreading toward a fuel break using a multiphase physical model. *International Journal of Wildland Fire*. 14: 141–151.
- Fahnestock, G.R. 1970.** Two keys for appraising forest fire fuels. Res. Pap. PNW-99. Portland, OR: U.S. Department of Agriculture, Forest Service, Pacific Northwest Forest and Range Experiment Station. 26 p.
- Finney, M.A. 2004.** FARSITE: Fire area simulator—model development and evaluation. Res. Pap. RMRS-RP-4 Revised. Fort Collins, CO: U.S. Department of Agriculture, Forest Service, Rocky Mountain Research Station. 47 p.
- Finney, M.A. 2006.** An overview of FlamMap fire modelling capabilities. In: Andrews, P.L.; Butler, B.W., comps. *Fuels management—how to measure success: conference proceedings*. Proc. RMRS-P-41. Fort Collins, CO: U.S. Department of Agriculture, Forest Service, Rocky Mountain Research Station: 213–220.
- Folweiler, A.D. 1937.** Theory and practice of forest fire protection in the United States. St. Louis, MO: John S. Swift Co., Inc. 163 p.
- Forestry Canada Fire Danger Group. 1992.** Development and structure of the Canadian Forest Fire Behavior Prediction System. Inf. Rep. ST-X-3. Ottawa, ON: Forestry Canada, Science and Sustainable Development Directorate. 63 p.
- Gisborne, H.T. 1948.** Fundamentals of fire behavior. *Fire Control Notes*. 9(1): 13–24. [Republished in 2004 as: *Fire Management Today*. 64(1): 15–23.]
- Goens, D.W.; Andrews, P.L. 1998.** Weather and fire behavior factors related to the Dude Fire, AZ. In: Preprint volume of second symposium on fire and forest meteorology. Boston, MA: American Meteorological Society: 153–158.
- Graham, R.T., tech. ed. 2003.** Hayman Fire case study. Gen. Tech. Rep. RMRS-GTR-114. Ogden, UT: U.S. Department of Agriculture, Forest Service, Rocky Mountain Research Station. 396 p.
- Hartford, R.A.; Rothermel, R.C. 1991.** Fuel moisture as measured and predicted during the 1988 fires in Yellowstone National Park. Res. Note INT-396. Ogden, UT: U.S. Department of Agriculture, Forest Service, Intermountain Research Station. 7 p.
- Hirsch, K.G.; Martell, D.L.; Corey, P.N. 2000.** Probability of containment by medium initial attack crews in the boreal spruce fuel type. [Poster with text.] Edmonton, AB: Natural Resources Canada, Canadian Forest Service, Northern Forestry Centre.
- Hough, W.A. 1973.** Fuel and weather influence wildfires in sand pine forests. Res. Pap. SE-174. Asheville, NC: U.S. Department of Agriculture, Forest Service, Southeastern Forest Experiment Station. 11 p.
- Kerr, W.L.; Buck, C.C.; Cline, W.E.; Martin, S.; Nelson, W.D. 1971.** Nuclear weapons effects in a forest environment—thermal and fire. Rep. N2: TR 2-70. Santa Barbara, CA: General Electric Company-TEMPO and Department of Defense Nuclear Information Analysis Center.
- Keyes, C.R. 2006.** Role of foliar moisture content in the silvicultural management of forest fuels. *Western Journal of Applied Forestry*. 21: 228–231.
- Kiil, A.D.; Grigel, J.E. 1969.** The May 1968 forest conflagrations in central Alberta—a review of fire weather, fuels and fire behavior. Inf. Rep. A-X-24. Edmonton, AB: Canada Department of Fisheries and Forestry, Forestry Branch, Forest Research Laboratory. 36 p.
- Lindenmuth, A.W., Jr.; Davis, J.R. 1973.** Predicting fire spread in Arizona's oak chaparral. Res. Pap. RM-101. Fort Collins, CO: U.S. Department of Agriculture, Forest Service, Rocky Mountain Forest and Range Experiment Station. 11 p.



- Linn, R.; Reisner, J.; Colman, J.J.; Winterkamp, J. 2002.** Studying wildfire behavior using FIRETEC. *International Journal of Wildland Fire*. 11: 233–246.
- Maclean, N. 1992.** *Young men and fire*. Chicago, IL: University of Chicago Press. 301 p.
- McAlpine, R.S.; Lawson, B.D.; Taylor, E. 1991.** Fire spread across a slope. In: Andrews, P.L.; Potts, D.F., eds. *Proceedings of the 11<sup>th</sup> conference on fire and forest meteorology*. SAF Publ. 91-04. Bethesda, MD: Society of American Foresters: 218–225.
- McAlpine, R.S.; Wakimoto, R.H. 1991.** The acceleration of fire spread from point source to equilibrium spread. *Forest Science*. 37: 1314–1337.
- McArthur, A.G. 1965.** Fire behaviour characteristics of the Longford Fire. Leaflet No. 91. Canberra, Australian Capital Territory: Commonwealth of Australia, Forest and Timber Bureau, Forest Research Institute. 19 p.
- Mell, W.; Jenkins, M.A.; Gould, J.; Cheney, P. 2007.** A physics-based approach to modelling grassland fires. *International Journal of Wildland Fire*. 16: 1–22.
- Menning, K.M.; Stephens, S.L. 2007.** Fire climbing in the forest: a semiquantitative, semiquantitative approach to assessing ladder fuel hazards. *Western Journal of Applied Forestry*. 22: 88–93.
- Mottus, B.; Pengelly, I. 2004.** An analysis of the meteorological conditions associated with the 1999 Panther River Fire in Banff National Park [abstract]. In: Engstrom, R.T.; Galley, K.E.M.; de Groot, W.J.; eds. *Proceedings of the 22<sup>nd</sup> Tall timbers fire ecology conference: fire in temperate, boreal, and montane ecosystems*. Tallahassee, FL: Tall Timbers Research Station: 239.
- Murphy, K.; Rich, T.; Sexton, T. 2007.** An assessment of fuel treatment effects on fire behavior, suppression effectiveness, and structure ignition on the Angora Fire. Tech. Publ. R5-TP-025. Vallejo, CA: U.S. Department of Agriculture, Forest Service, Pacific Southwest Region. 32 p.
- National Wildfire Coordinating Group. 1993.** Look up, look down, look around [VHS videotape; 50 minutes]. Publication NFES 2244. Boise, ID: National Fire Equipment System, Boise Interagency Fire Center.
- Nelson, R.M., Jr. 1993.** Byram's energy criterion for wildland fires: units and equations. Res. Note INT-415. Ogden, UT: U.S. Department of Agriculture, Forest Service, Intermountain Research Station. 5 p.
- Paxton, J. 2007.** The monster reared his ugly head—the story of Rodeo-Chediski Fire and fire as a tool of nature. Snowflake, AZ: Cedar Hill Publishing. 217 p.
- Pence, M.; Zimmerman, T. 2011.** The Wildland Fire Decision Support System: integrating science, technology, and fire management. *Fire Management Today*. 71(1): 18–22.
- Reinhardt, E.D.; Crookston, N.L., tech eds. 2003.** The Fire and Fuels Extension to the Forest Vegetation Simulator. Gen. Tech. Rep. RMRS-GTR-116. Ogden, UT: U.S. Department of Agriculture, Forest Service, Rocky Mountain Research Station. 209 p.
- Rothermel, R.C. 1972.** A mathematical model for predicting fire spread in wildland fuels. Res. Pap. INT-115. Ogden, UT: U.S. Department of Agriculture, Forest Service, Intermountain Forest and Range Experiment Station. 40 p.
- Rothermel, R.C. 1983.** How to predict the spread and intensity of forest and range fires. Gen. Tech. Rep. INT-143. Ogden, UT: U.S. Department of Agriculture, Forest Service, Intermountain Forest and Range Experiment Station. 161 p.

- Rothermel, R.C. 1985.** Fire behavior considerations of aerial ignition In: Mutch, R.W., tech. coord. Prescribed fire by aerial ignition, proceedings of a workshop. Missoula, MT: Intermountain Fire Council: 143–158.
- Rothermel, R.C. 1991.** Predicting behavior and size of crown fires in the northern Rocky Mountains. Res. Pap. INT-438. Ogden, UT: U.S. Department of Agriculture, Forest Service, Intermountain Research Station. 46 p.
- Rothermel, R.C. 1993.** Mann Gulch Fire: a race that couldn't be won. Gen. Tech. Rep. INT-299. Ogden, UT: U.S. Department of Agriculture, Forest Service, Intermountain Research Station. 10 p.
- Rothermel, R.C.; Hartford, R.A.; Chase, C.H. 1994.** Fire growth maps for the 1988 Greater Yellowstone Area fires. Gen. Tech. Rep. INT-304. Ogden, UT: U.S. Department of Agriculture, Forest Service, Intermountain Research Station. 64 p.
- Rothermel, R.C.; Mutch, R.W. 1986.** Behavior of the life-threatening Butte Fire: August 27–29, 1985. Fire Management Notes. 47(2): 14–24. [Republished in 2003 as: Fire Management Today. 63(4): 31–39.]
- Schaaf, M.D.; Sandberg, D.V.; Schreuder, M.D.; Riccardi, C.L. 2007.** A conceptual framework for ranking crown fire potential in wildland fuelbeds. Canadian Journal of Forest Research. 37: 2464–2478.
- Schroeder, M.J.; Buck, C.C. 1970.** Fire weather ... a guide for application of meteorological information to forest fire control operations. Agric. Handb. 360. Washington, DC: U.S. Department of Agriculture. 229 p.
- Scott, J.H. 2006.** Comparison of crown fire modeling systems used in three fire management applications. Res. Pap. RMRS-RP-58. Fort Collins, CO: U.S. Department of Agriculture, Forest Service, Rocky Mountain Research Station. 25 p.
- Scott, J.H.; Reinhardt, E.D. 2001.** Assessing crown fire potential by linking models of surface and crown fire behavior. Res. Pap. RMRS-RP-29. Fort Collins, CO: U.S. Department of Agriculture, Forest Service, Rocky Mountain Research Station. 59 p.
- Simard, A.J.; Haines, D.A.; Blank, R.W.; Frost, J.S. 1983.** The Mack Lake Fire. Gen. Tech. Rep. NC-83. St. Paul, MN: U.S. Department of Agriculture, Forest Service, North Central Forest Experiment Station. 36 p.
- Stocks, B.J.; Alexander, M.E.; Wotton, B.M.; Stefner, C.N.; Flannigan, M.D.; Taylor, S.W.; Lavoie, N.; Mason, J.A.; Hartley, G.R.; Maffey, M.E.; Dalrymple, G.N.; Blake, T.W.; Cruz, M.G.; Lanoville, R.A. 2004.** Crown fire behaviour in a northern jack pine-black spruce forest. Canadian Journal of Forest Research. 34: 1548–1560.
- Stocks, B.J.; Hartley, G.R. 1995.** Fire behavior in three jack pine fuel complexes. [Poster with text.] Sault Ste. Marie, ON: Natural Resources Canada, Canadian Forest Service, Great Lakes Forestry Centre.
- Sullivan, A.L. 2009a.** Improving operational models of fire behaviour. In: Anderssen, R.S.; Braddock, R.D.; Newham, L.T.H., eds. Proceedings of the 18<sup>th</sup> World IMACS Congress and MODSIM09 International Congress on modelling and simulation. Modelling and Simulation Society of Australia and New Zealand and International Association for Mathematics and Computers in Simulation: 2377–2383. <http://www.mssanz.org.au/modsim09/A4/sullivan.pdf>. (14 February 2010).
- Sullivan, A.L. 2009b.** Wildland surface fire spread modelling, 1990–2007. 1: Physical and quasi-physical models. International Journal of Wildland Fire. 18: 349–368.
- Sutton, M.W. 1984.** Extraordinary flame heights observed in pine fires on 16 February 1983. Australian Forestry. 47: 199–200.

- Taylor, S.W.; Pike, R.G.; Alexander, M.E. 1997.** Field guide to the Canadian Forest Fire Behavior Prediction (FBP) System. Spec. Publ. 11. Edmonton, AB: Natural Resources Canada, Canadian Forest Service, Northern Forestry Centre. 60 p.
- Taylor, S.W.; Wotton, B.M.; Alexander, M.E.; Dalrymple, G.N. 2004.** Variation in wind and crown fire behaviour in a northern jack pine-black spruce forest. *Canadian Journal of Forest Research*. 34: 1561–1576.
- Tymstra, C.; Bryce, R.W.; Wotton, B.M.; Taylor, S.W.; Armitage, O.B. 2010.** Development and structure of Prometheus: the Canadian wildland fire growth simulation model. Inf. Rep. NOR-X-417. Edmonton, AB: Natural Resources Canada, Canadian Forest Service, Northern Forestry Centre. 102 p.
- U.S. Department of Agriculture, Forest Service [USDA FS]. 1980.** Report on the National Fire Behavior Research conference. Washington, DC: Forest Fire and Atmospheric Sciences Research. 75 p. plus appendices.
- U.S. Department of Agriculture, Natural Resources Conservation Service [USDA NRCS]. 2010.** The PLANTS database. <http://plants.usda.gov>. (3 February 2011).
- Van Wagner, C.E. 1964.** History of a small crown fire. *Forestry Chronicle*. 40: 202–205, 208–209.
- Van Wagner, C.E. 1968.** Fire behaviour mechanisms in a red pine plantation: field and laboratory evidence. Dep. Publ. No. 1229. Ottawa, ON: Canada Department of Forestry and Rural Development, Forestry Branch. 30 p.
- Van Wagner, C.E. 1969.** A simple fire-growth model. *Forestry Chronicle*. 45: 103–104.
- Van Wagner, C.E. 1977a.** Conditions for the start and spread of crown fire. *Canadian Journal of Forest Research*. 7: 23–34.
- Van Wagner, C.E. 1977b.** Effect of slope on fire spread rate. *Canadian Forestry Service Bi-monthly Research Notes*. 33: 7–8.
- Van Wagner, C.E. 1985.** Fire behavior modelling—how to blend art and science. In: Donoghue, L.R.; Martin, R.E., eds. Proceedings of eighth conference on fire and forest meteorology. SAF Publ. 85–04. Bethesda, MD: Society of American Foresters: 3–5.
- Van Wagner, C.E. 1987.** Development and structure of the Canadian Forest Fire Weather Index System. For. Tech. Rep. 35. Ottawa, ON: Government of Canada, Canadian Forestry Service. 37 p.
- Van Wagner, C.E. 1993.** Prediction of crown fire behavior in two stands of jack pine. *Canadian Journal of Forest Research*. 23: 442–449.
- van Wagendonk, J.W.; Botti, S.J. 1984.** Modeling behavior of prescribed fires in Yosemite National Park. *Journal of Forestry*. 82: 479–484.
- Varner, J.M.; Keyes, C.R. 2009.** Fuels treatments and fire models: errors and corrections. *Fire Management Today*. 69(3): 47–50.
- Venkatesh, S.; Saito, K.; Rothermel, R.C. 2000.** Maximum spotting distance in wind-driven crown fires. *Nensho no Kagaku to Gijutsu*. 7: 221–233. [In English.]
- Wade, D.D.; Ward, D.E. 1973.** An analysis of the Air Force Bomb Range Fire. Res. Pap. SE-105. Asheville, NC: U.S. Department of Agriculture, Forest Service, Southeastern Forest Experiment Station. 38 p.
- Weber, M.G. 1995.** Fire research and the global village. *Forestry Chronicle*. 71: 584–588.
- Wendel, G.W.; Storey, T.G.; Byram, G.M. 1962.** Forest fuels on organic and associated soils in the Coastal Plain of North Carolina. Stn. Pap. 144. Asheville, NC: U.S. Department of Agriculture, Forest Service, Southeastern Forest Experiment Station.
- Wotton, B.M.; Alexander, M.E.; Taylor, S.W. 2009.** Updates and revisions to the 1992 Canadian Forest Fire Behavior Prediction System. Inf. Rep. GLC-X-10. Sault Ste. Marie, ON: Natural Resources Canada, Canadian Forest Service, Great Lakes Forestry Centre. 45 p.

## Acknowledgments

The Extreme Fire Behavior synthesis was funded by the Joint Fire Science Program (JFSP) Project Number 09-2-01-11 and a contribution from Project Number 09-S-03-1. The following individuals reviewed the entire manuscript and provided insightful comments: Don Haines (U.S. Forest Service, retired), Robert Ziel (Program Coordinator, Lake States Fire Science Consortium) and John Snook (Fire Weather/Predictive Services Program Manager, Northern California Geographic Area Coordination Center).

Each chapter was also peer reviewed, and we wish to acknowledge those individuals for their comments that significantly improved the document. Listed below are the chapter reviewers:

- Effects of Complex Terrain—Tom Rolinski (Fire Weather Program Manager, Southern California Geographic Area Coordination Center) and Kenn McCarty (California Department of Forestry and Fire Protection).
- Critical Fire Weather Patterns—Rick Ochoa (National Interagency Fire Center Predictive Services, retired), Heath Hockenberry (National

Weather Service), John Saltenberger (Fire Weather Services Program Manager, Northwest Geographic Area Coordination Center) and Julia Rutherford (National Weather Service).

- Fire Interactions and Mass Fires—Two anonymous reviewers.
- Column/Plume Dynamics and Spot Fires—Joseph J. Charney (U.S. Forest Service, Northern Research Station) and Don Haines (U.S. Forest Service, retired) for plume section; Nicholas Gellie (Australian Fire Behavior Analyst) and Marty Alexander (Alberta School of Forest Science and Management, University of Alberta, Edmonton, Canada) for spotting section.
- Vortices and Wildland Fire—Don Haines and two anonymous reviewers.
- Crown Fire—Dave Thomas (U.S. Forest Service, retired), Philip Omi (Professor Emeritus, Colorado State University), C. Hoffman (University of Idaho) and J. Kern (Florida Division of Forestry).

The authors also thank Victoria Werth for her help in writing the final document summary and to Victoria Werth and Lynn Sullivan for editing and formatting the manuscript in preparation for publication.

## Unit Conversion Factors<sup>a</sup>

SI unit	Multiplication factor	English unit	Inverse factor
Degrees Celsius (°C)	5/9 (°F - 32)	= Degrees Fahrenheit (°F)	(9/5 °C) + 32
Hectares (ha)	2.47	= Acres (ac)	0.405
Kilograms (kg)	2.205	= Pounds (lb)	0.454
Kilograms per cubic meter (kg/m <sup>3</sup> )	0.624	= Pounds per cubic foot (lb/ft <sup>3</sup> )	16.0
Kilograms per square meter (kg/m <sup>2</sup> )	0.205	= Pounds per square foot (lb/ft <sup>2</sup> )	4.88
Kilograms per second per square meter (kg sec <sup>-1</sup> m <sup>-2</sup> )	737.463	= Pounds per hour per square foot (lb hr <sup>-1</sup> .ft <sup>2</sup> )	0.001356
Kilograms per square meter (kg/m <sup>2</sup> )	4.46	Tons per acre (t/ac)	0.224
Hectopascals (hPa)	0.0145	= Pounds per square inch (lb/in <sup>2</sup> )	68.94

SI unit	Multiplication factor	English unit	Inverse factor
Kilojoules per kilogram (kJ/kg)	0.430	British thermal units per pound (BTU/lb)	2.32
Kilometers (km)	0.621	= Miles (mi)	1.61
Kilometers per hour (km/h)	0.621	= Miles per hour (mi/h)	1.61
Kilowatts per meter (kW/m)	0.289	= BTUs per second per foot (BTU/s-ft)	3.46
Megawatts (MW)	56,869	= BTUs per minute (BTU/min)	0.0000176
Centimeters (cm)	0.394	Inches	2.54
Meters (m)	3.28	Feet (ft)	0.305
Square meters (m <sup>2</sup> )	10.764	= Square feet	0.0929
Meters per minute (m/min)	3.28	Feet per minute (ft/min)	0.305
Meters per minute (m/min)	2.98	= Chains per hour (ch/h)	0.335
Meters per second (m/s)	3.28	= Feet per second (ft/s)	0.305
Number per hectare (No./ha)	0.405	= Number per acre (No./ac)	2.47
Square meters per hectare (m <sup>2</sup> /ha)	4.36	= Square feet per acre (ft <sup>2</sup> /ac)	0.230

<sup>a</sup> Factors are given to three significant digits. To convert an English unit to a Standard International Unit (SI) unit, multiply by the inverse factor given in the right-hand column.

## Common and Scientific Names<sup>a</sup>

Common name	Scientific name
Douglas-fir	<i>Pseudotsuga menziesii</i> (Mirb.) Franco
Eucalyptus	<i>Eucalyptus</i> spp.
Jack pine	<i>Pinus banksiana</i> Lamb.
Lodgepole pine	<i>Pinus contorta</i> Douglas ex. Louden
Ponderosa pine	<i>Pinus ponderosa</i> C. Lawson
Red pine	<i>Pinus resinosa</i> Aiton
Sand pine	<i>Pinus clausa</i> (Chapm. ex Engelm.) Vasey ex Sarg.
Singleleaf pinyon	<i>Pinus monophylla</i> Torr. & Frém.
Utah juniper	<i>Juniperus osteosperma</i> (Torr.) Little
White pine	<i>Pinus strobus</i> L.
Spruce	<i>Picea</i> spp.

<sup>a</sup> Source: USDA NRCS 2008.

**Pacific Northwest Research Station**

<b>Web site</b>	<a href="http://www.fs.fed.us/pnw">http://www.fs.fed.us/pnw</a>
<b>Telephone</b>	(503) 808-2592
<b>Publication requests</b>	(503) 808-2138
<b>FAX</b>	(503) 808-2130
<b>E-mail</b>	<a href="mailto:pnw_pnwpubs@fs.fed.us">pnw_pnwpubs@fs.fed.us</a>
<b>Mailing address</b>	Publications Distribution Pacific Northwest Research Station P.O. Box 3890 Portland, OR 97208-3890



Federal Recycling Program  
Printed on Recycled Paper



---

U.S. Department of Agriculture  
Pacific Northwest Research Station  
333 SW First Avenue  
P.O. Box 3890  
Portland, OR 97208-3890

---

Official Business  
Penalty for Private Use, \$300